



ITS
Institut
Teknologi
Sepuluh Nopember

Sistem Monitoring Charging Station Mobil Listrik berbasis Embedded Web Server

Dosen Pembimbing :
Suwito, ST., MT.
Dr. Dimas Anton Asfani, ST., MT.

Gilang Dwi Pamungkas. – 2211100077
Bidang Studi Elektronika
Jurusan Teknik Elektro FTI
Institut Teknologi Sepuluh Nopember Surabaya

PENDAHULUAN

- ▶ Latar Belakang
- ▶ Perumusan Masalah
- ▶ Batasan Masalah
- ▶ Tujuan Tugas Akhir

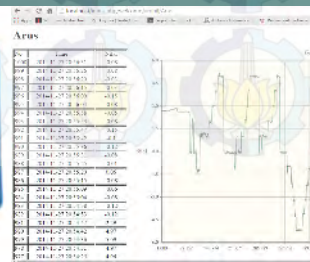
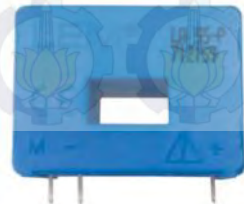

Latar Belakang

- ▶ Rencana pembangunan *charging station* MOLINA di ITS
- ▶ Diperlukan informasi tegangan dan arus agar diketahui daya yang sedang terpakai
- ▶ Dibutuhkan tampilan informasi tersebut ke dalam bentuk Web secara *real time*, dan juga data *logger* nilai - nilai tegangan dan arus sebelumnya
- ▶ Di masa depan ketika *charging station* bersifat komersial, pemilik EV (*Electric Vehicle*) dapat mengetahui *charging station* mana yang kapasitas dayanya masih *available* dengan mengakses Web *charging station* tersebut

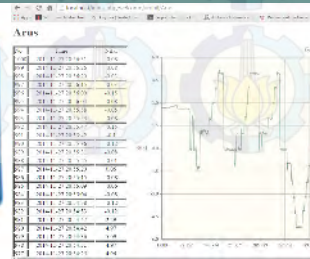
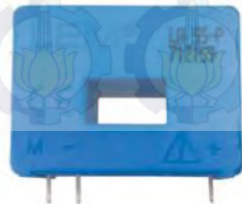

Perumusan Masalah

- ▶ Bagaimana mendesain keseluruhan sistem monitoring berbasis web server
- ▶ Bagaimana teknik akuisisi data sensor
- ▶ Bagaimana mengolah data hasil pembacaan sensor pada mikrokontroler
- ▶ Bagaimana desain *user interface* sistem monitoring yang *user-friendly*

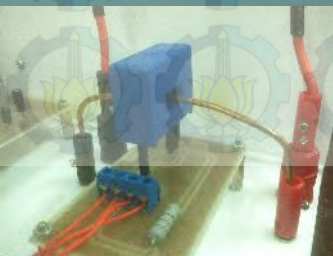
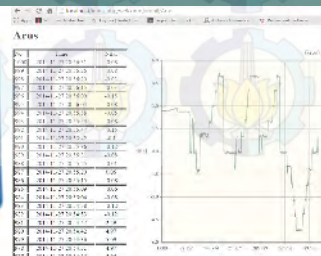
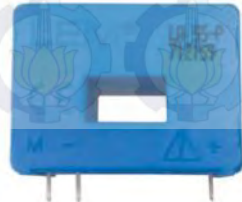

Batasan Masalah

- ▶ Sensor tegangan yang digunakan ialah LEM LV 25-P
- ▶ Sensor arus yang digunakan ialah LEM LA 55-P
- ▶ Tegangan DC yang diukur tidak lebih dari 500 V.
- ▶ Arus yang diukur tidak lebih dari 50 A.
- ▶ Mikrokontroler yang digunakan ialah arduino Uno R3 dengan Ethernet *shield* sebagai modul untuk terhubung dengan jaringan
- ▶ Router yang digunakan untuk membuat jaringan lokal ialah TP-LINK TL-MR3020
- ▶ Data arus dan tegangan disimpan dalam Database MySql dan dengan webserver Apache di OS Windows 7 64-bit
- ▶ Hanya 1000 data terakhir yang disimpan dalam Database MySql

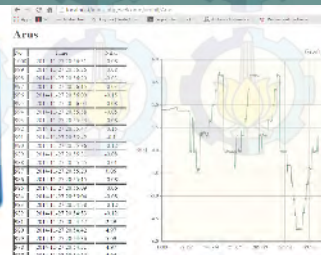
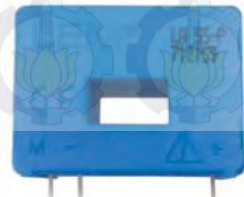

Tujuan Tugas Akhir

- ▶ Mewujudkan sebuah sistem monitoring jarak jauh yang diimplementasikan pada *charging station* untuk memonitoring tegangan dan arus di titik tertentu
- ▶ Memperoleh teknik yang tepat untuk melakukan pembacaan nilai tegangan dan arus dengan rating tinggi
- ▶ Mengetahui respon dari sensor tegangan dan arus rating tinggi

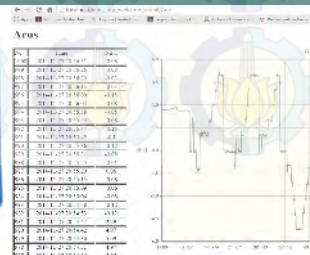
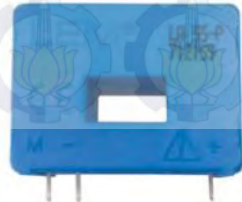

PERANCANGAN SISTEM

- ▶ Ilustrasi Cara Kerja Sistem
- ▶ Diagram Blok Sistem
- ▶ Perancangan *Hardware*
- ▶ Perancangan *Software*

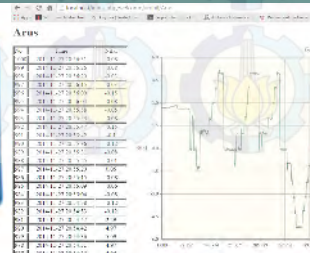

Ilustrasi Cara Kerja Sistem

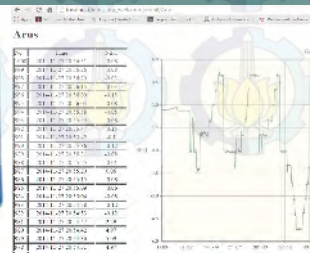
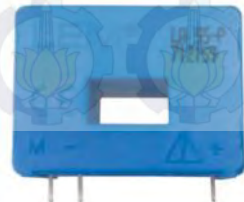
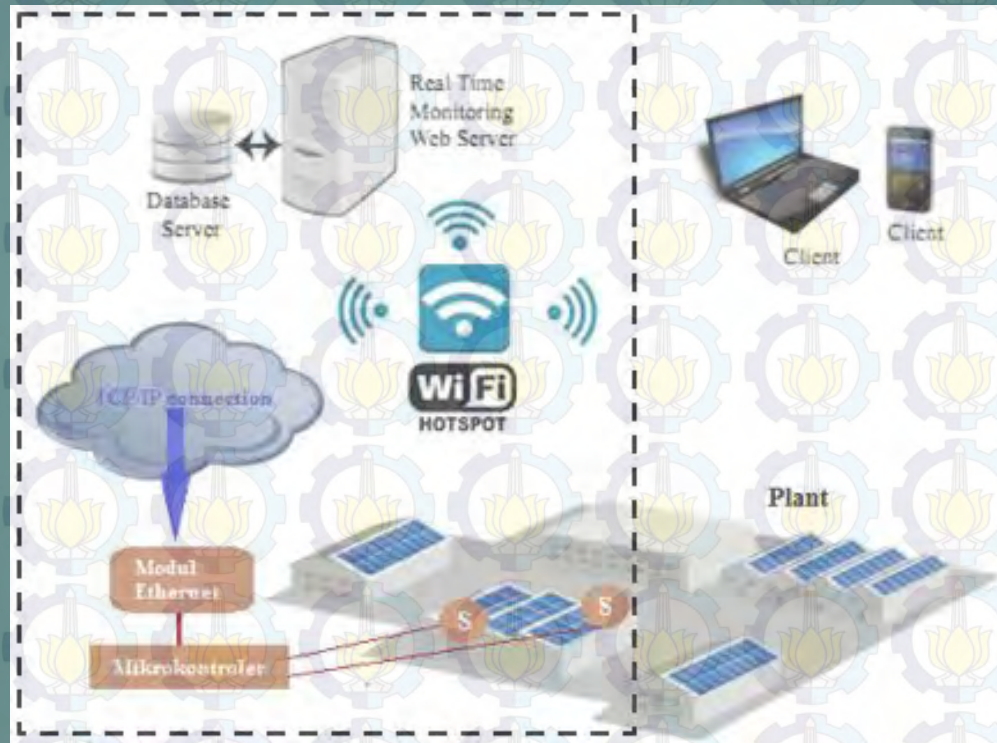
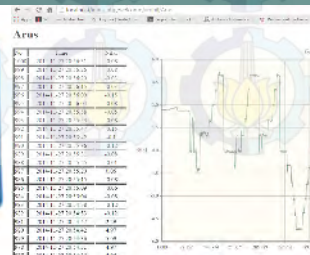
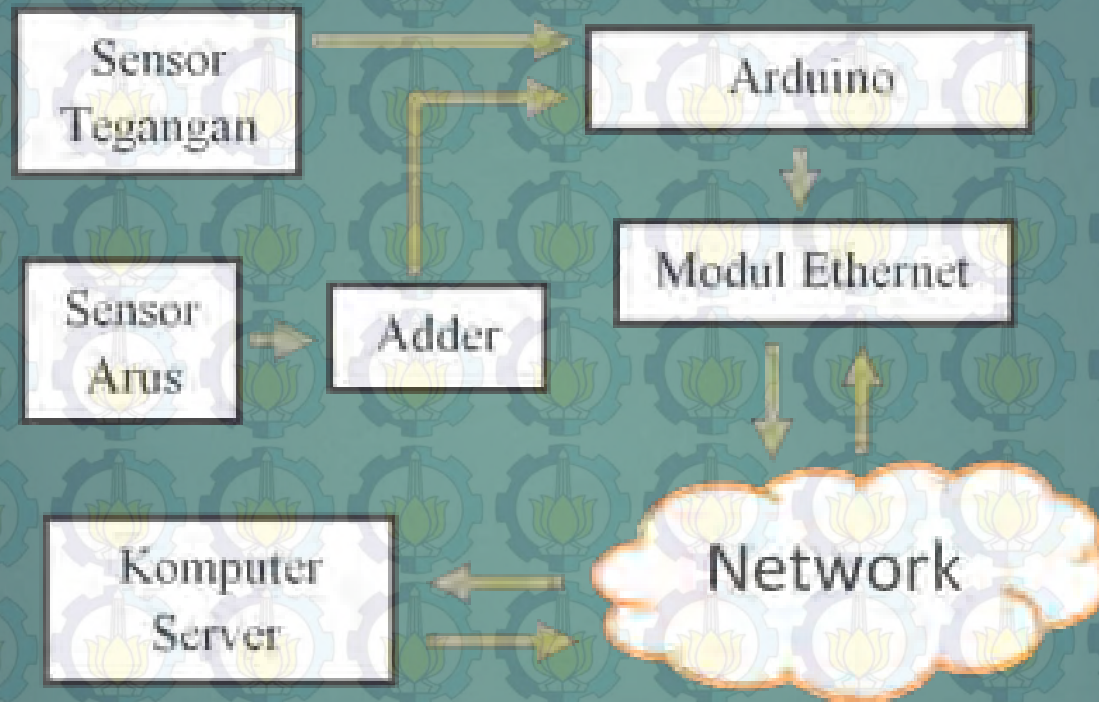
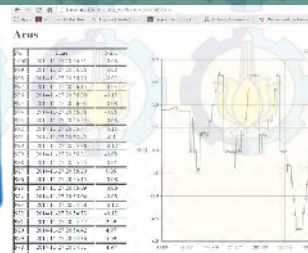
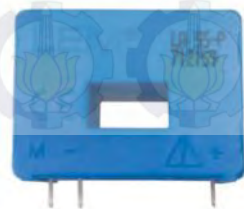
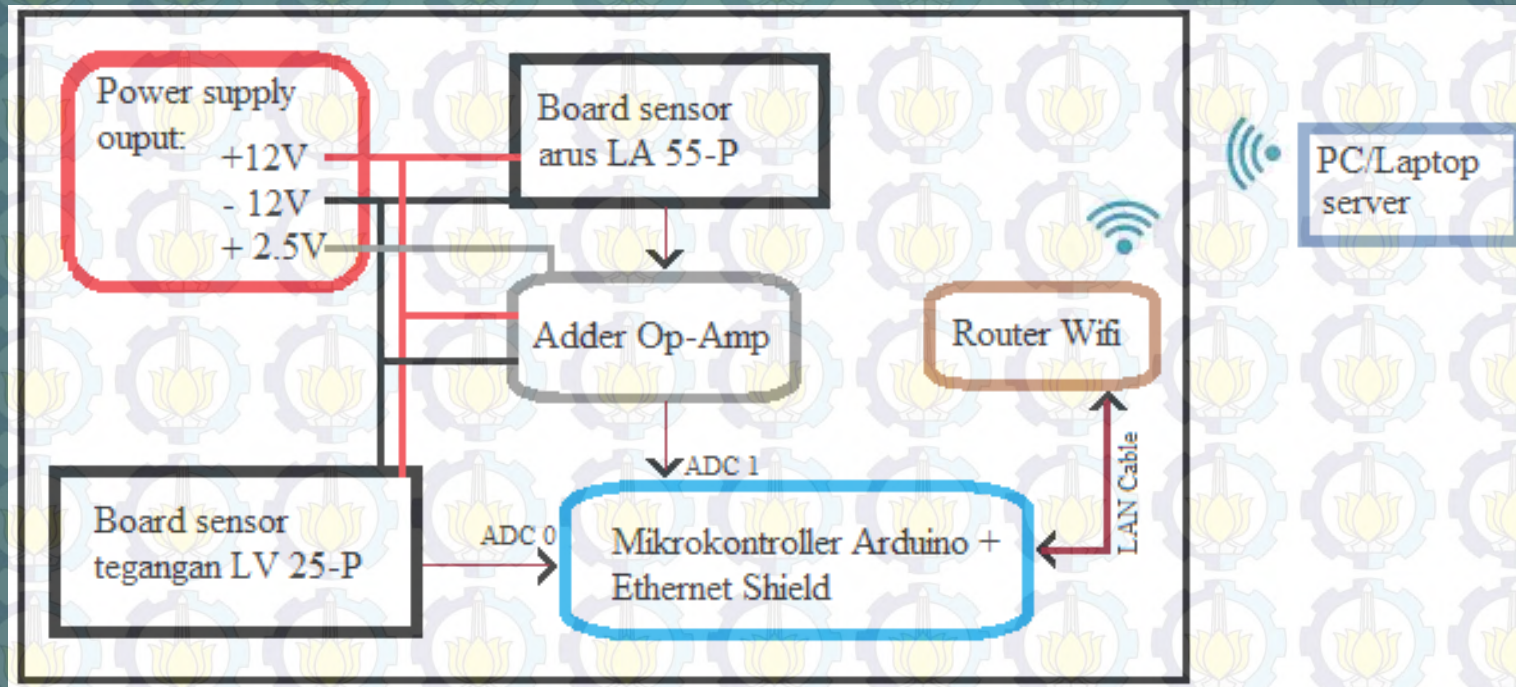

Diagram Blok Sistem



Perancangan Hardware (1)



Perancangan Hardware (2)

Power Supply

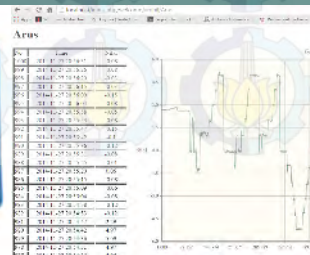
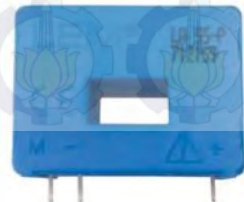
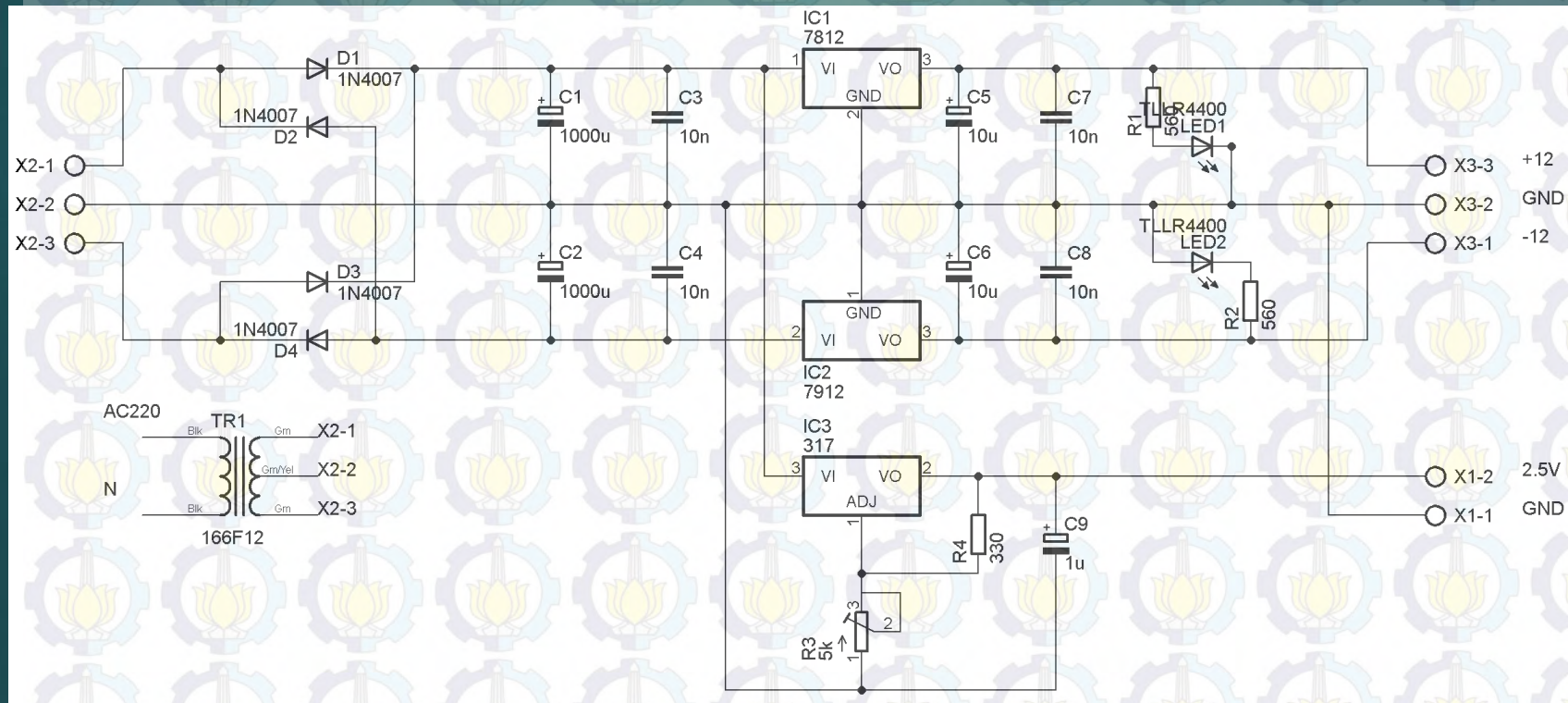

Perancangan Hardware (3)

Board Sensor Tegangan LV 25-P

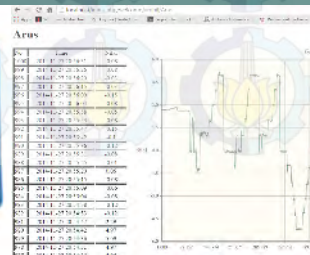
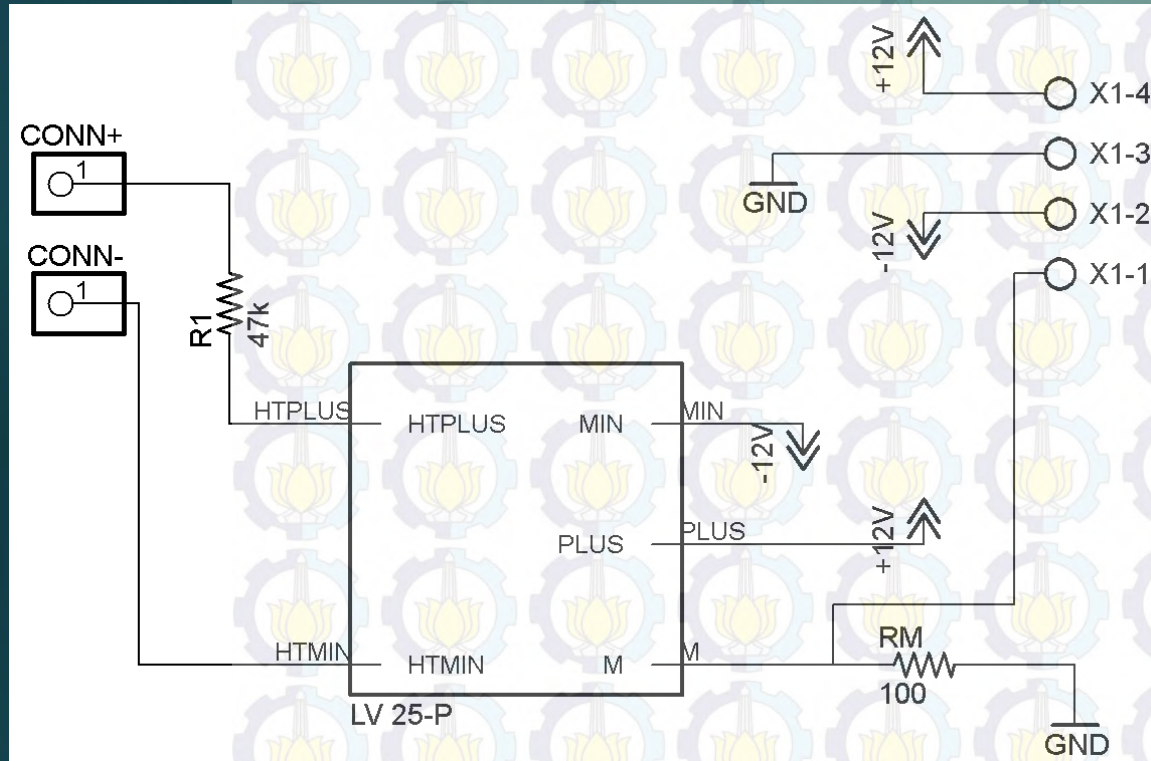

Perancangan Hardware (4)

Board Sensor Arus LA 55-P

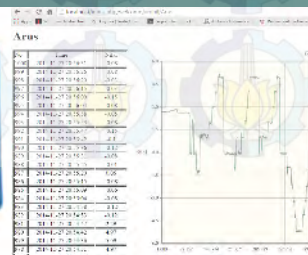
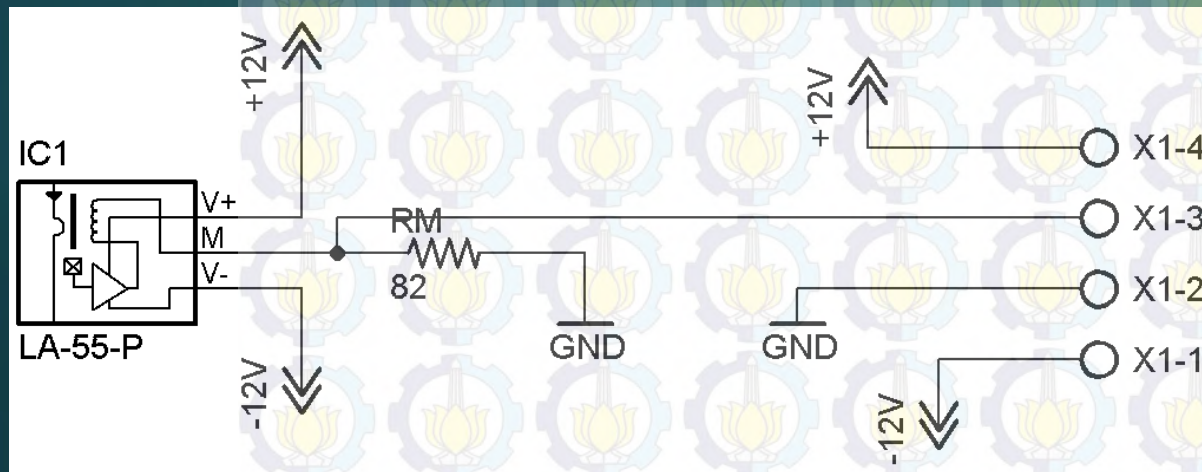

Perancangan Hardware (5)

Summing Amplifier

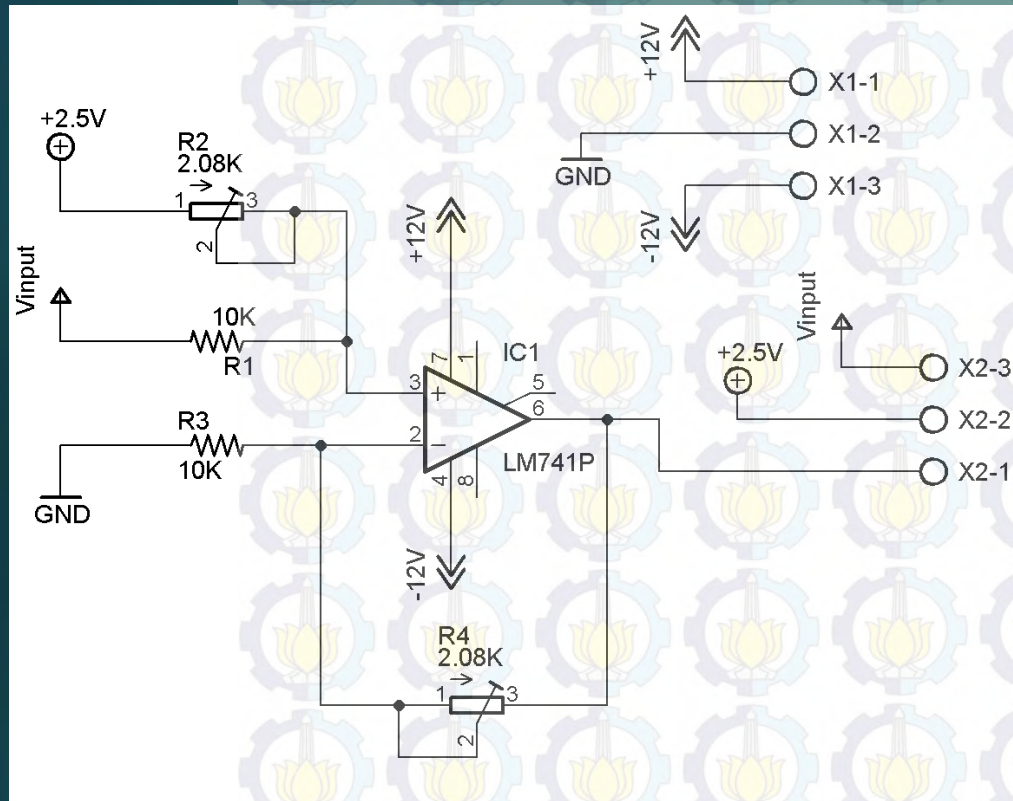

$$V_o = \left(V_1 \cdot \frac{R_2}{R_1 + R_2} + V_2 \cdot \frac{R_1}{R_1 + R_2} \right) \cdot \left(1 + \frac{R_4}{R_3} \right)$$

$$V_1 = V_{input}$$

$$V_2 = 2.5V$$

$$R_1 = R_3 = 10K$$

$$R_2 = R_4 = 2.08K$$

$$V_o = V_{output}$$

- ▶ Dengan begitu jika V_{input} bernilai +12V, maka V_{output} akan bernilai 4.996V
- ▶ Sedangkan jika V_{input} bernilai 0V, maka V_{output} akan bernilai 2.5V,
- ▶ dan jika V_{input} bernilai -12V, maka V_{output} akan bernilai 0.004V

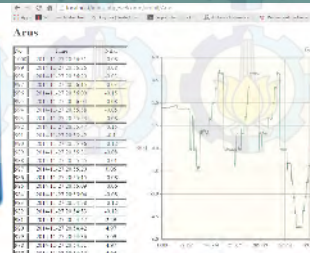
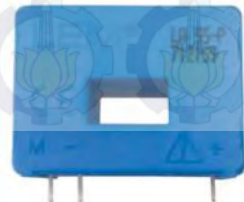

Perancangan Hardware (6)

Mikrokontroler Arduino dan Ethernet Shield

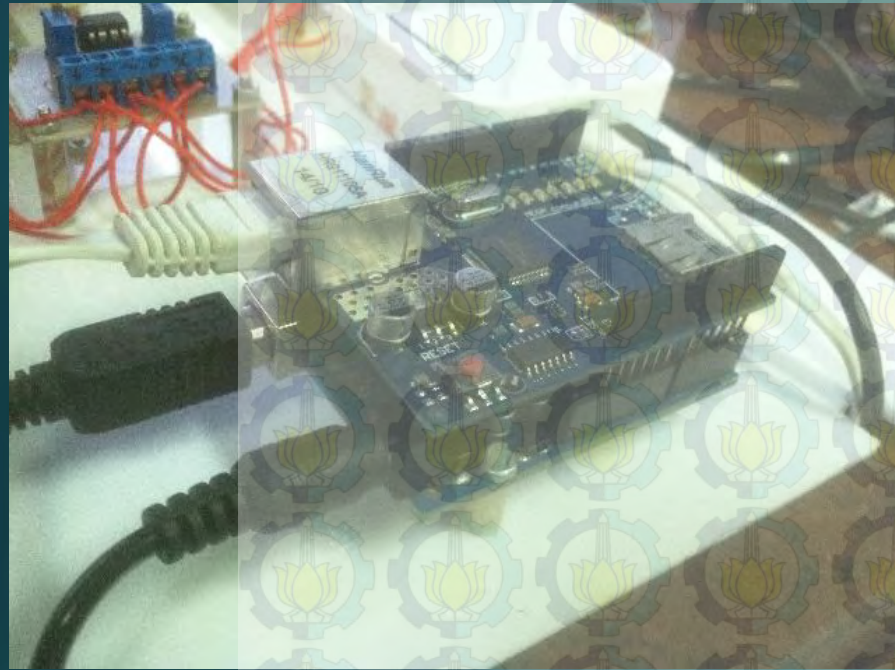

Ethernet *shield* ditumpukkan diatas arduino agar arduino dapat berkomunikasi dengan *device* lain melalui jaringan (*network*), bahkan dapat membuat arduino dapat terkoneksi dengan internet. Dengan kata lain, menggunakan modul ethernet ini, arduino memiliki mac address dan ip address.

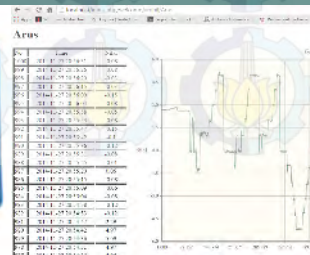
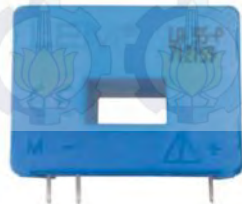

Perancangan Hardware (7)

Wifi Router TP-Link TL-MR3020

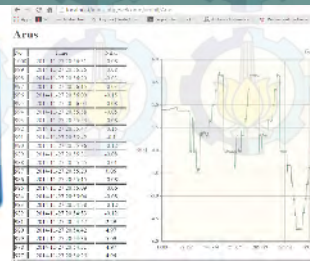
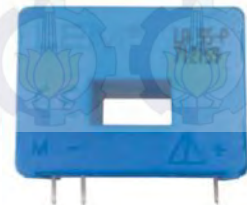

Perancangan Software

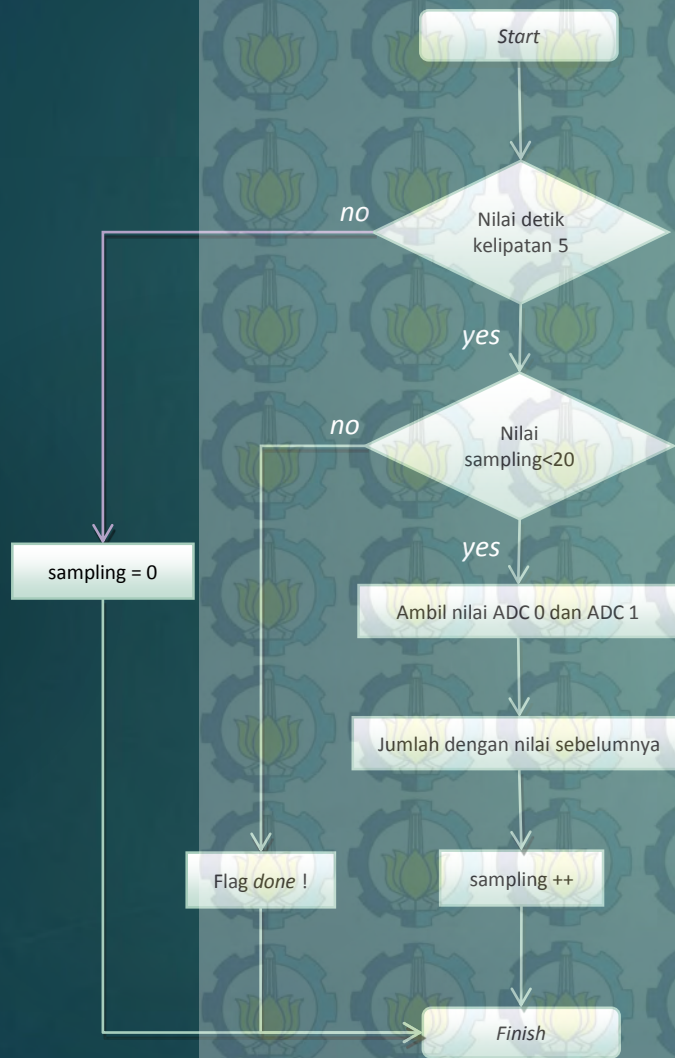

Flow chart interrupt timer2, 2 KHz

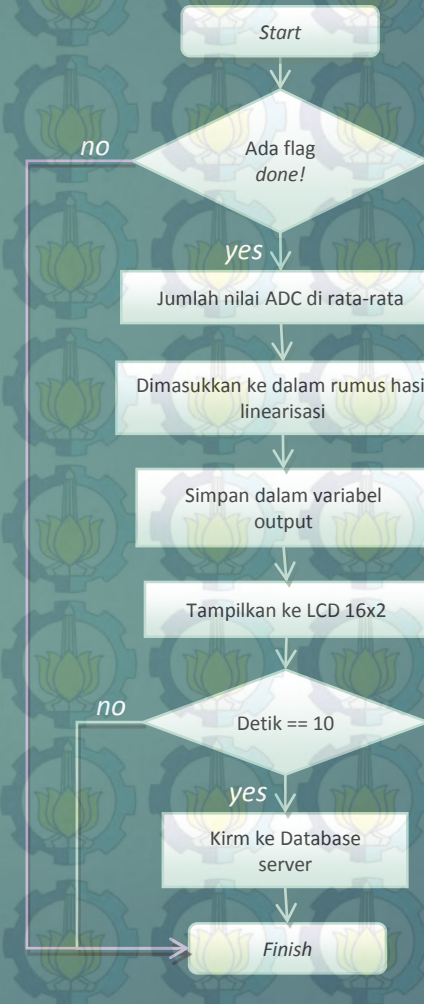

Flow chart main loop mikrokontroller

PENGUJIAN DAN ANALISIS

- ▶ Pengujian Power Supply
- ▶ Pengujian Rangkaian Summing Amplifier
- ▶ Karakterisasi Sensor Tegangan
- ▶ Karakterisasi Sensor Arus
- ▶ Pengujian Pembacaan Sensor Tegangan dan Arus
- ▶ Pengujian Sistem Keseluruhan
- ▶ Pengujian Pada Sumber DC Lain

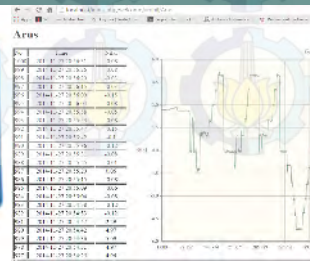
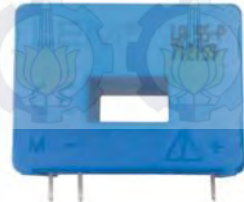

Pengujian Power Supply



Pin	Nilai Terukur (V)
12V	12.06
-12V	-11.84
2.5V	2.513

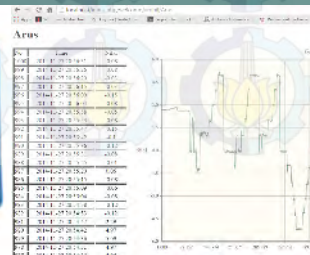

Pengujian Summing Amplifier



Input (V)	Output (V)
0	2.559
3	3.172
6	3.79
9	4.41
12	5.02
-3	1.92
-6	1.282
-9	0.643
-12	0.01

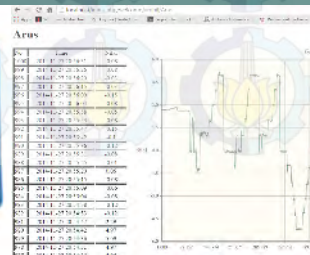

Karakterisasi Sensor Tegangan

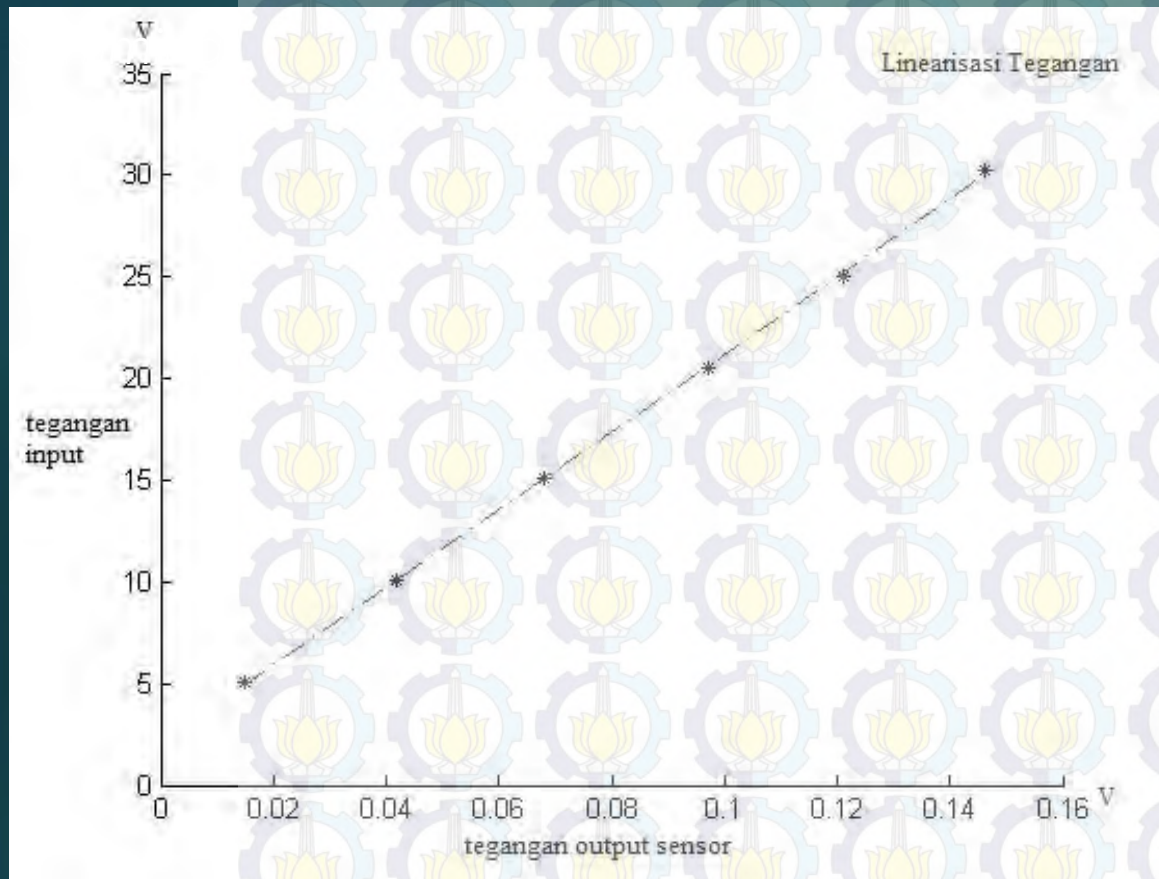

Tegangan Input (V)	Tegangan Output (V)
5.04	0.015
10.1	0.042
15.08	0.068
20.54	0.097
24.99	0.121
30.24	0.146

$$Y = 191.1892 * X + 2.0831$$

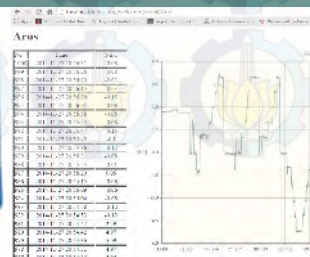
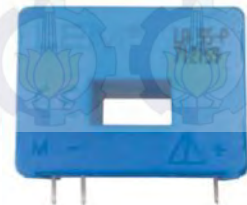

Karakterisasi Sensor Arus

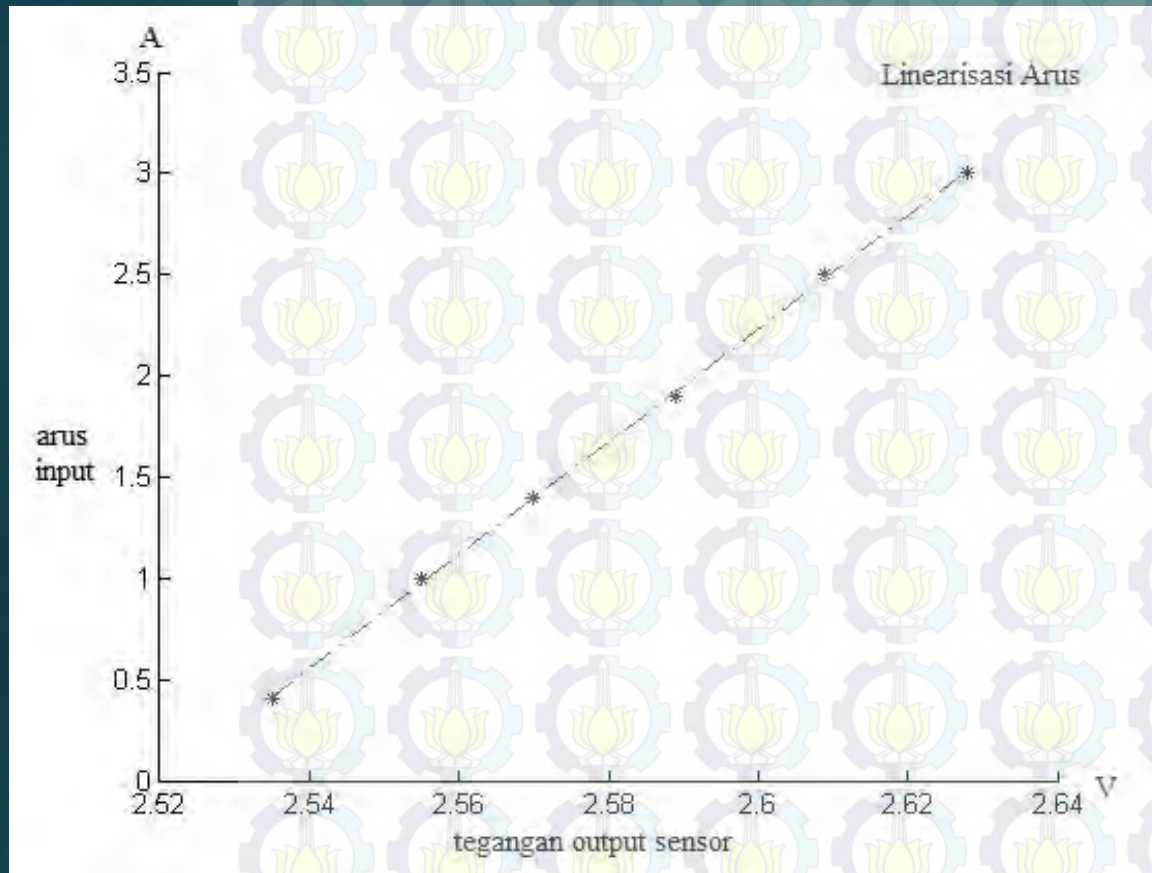

Arus Input (A)	Tegangan Output (V)
0.4	2.535
1	2.555
1.4	2.57
1.9	2.589
2.5	2.609
3	2.628

$$Y = 27.8727 * X - 70.2394$$

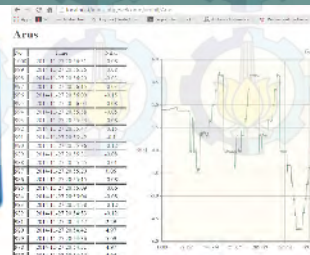
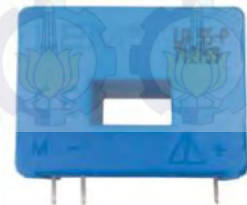

Pengujian Pembacaan Sensor Tegangan dan Sensor Arus

Multimeter (V)	Hasi Pembacaan Mikrokontroller (V)	Error (%)
5.65	5.045	10.7
11.55	11.249	2.6
17.08	16.705	2.2
25.14	24.904	0.9
31.47	31.131	1.1

Clamp meter (A)	Hasil Pembacaan Mikrokontroller (A)	Error (%)
0.9	0.885	1.7
1.5	1.607	7.1
2	2.149	7.5
2.8	2.872	2.6
3.4	3.397	0.1

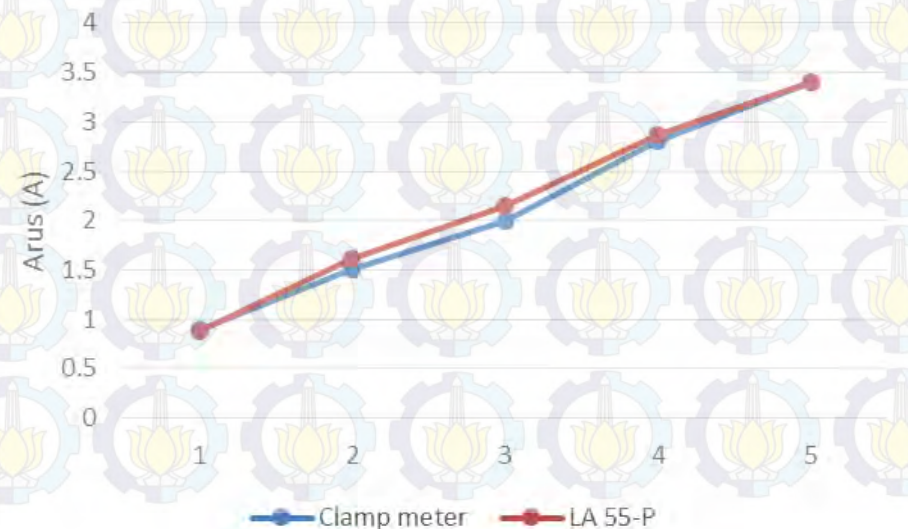
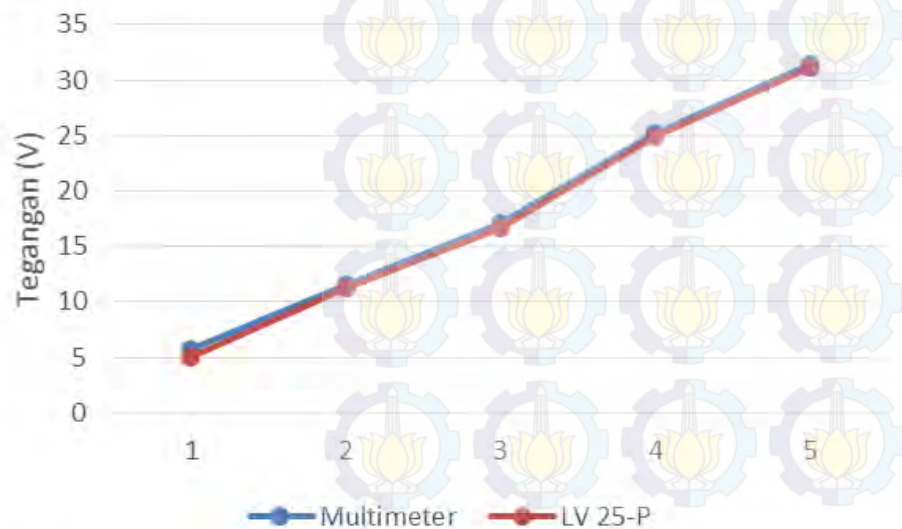
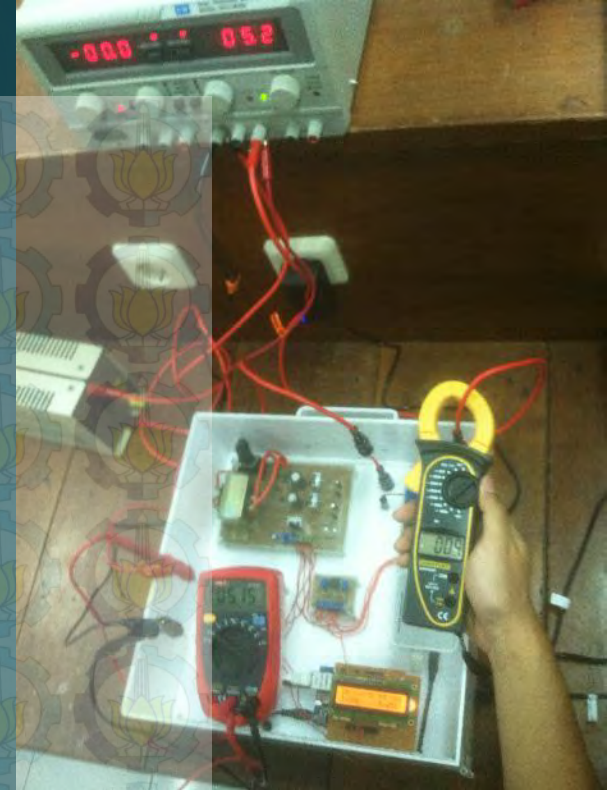

Pengujian Sistem Keseluruhan

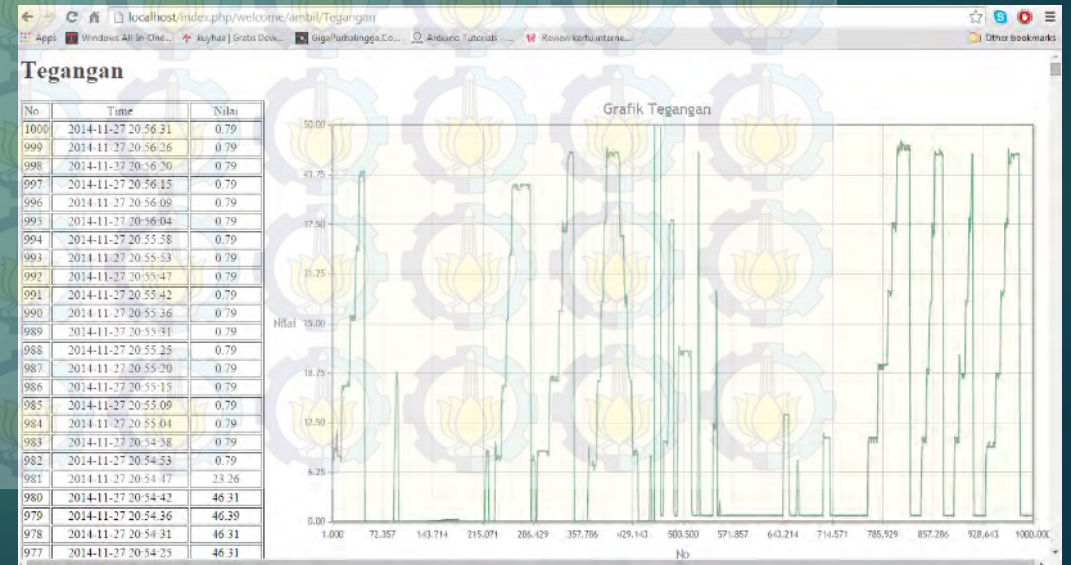
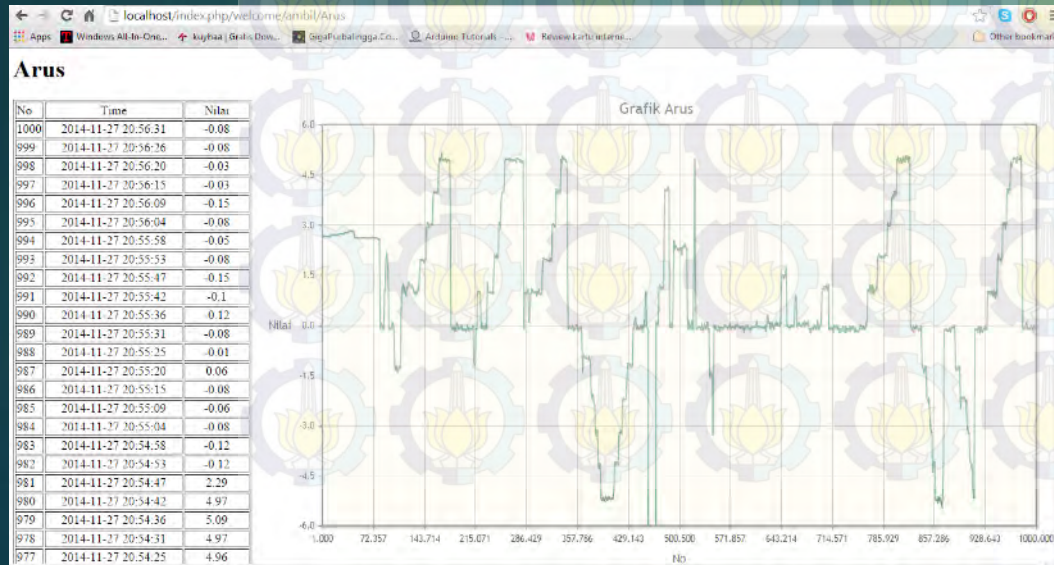
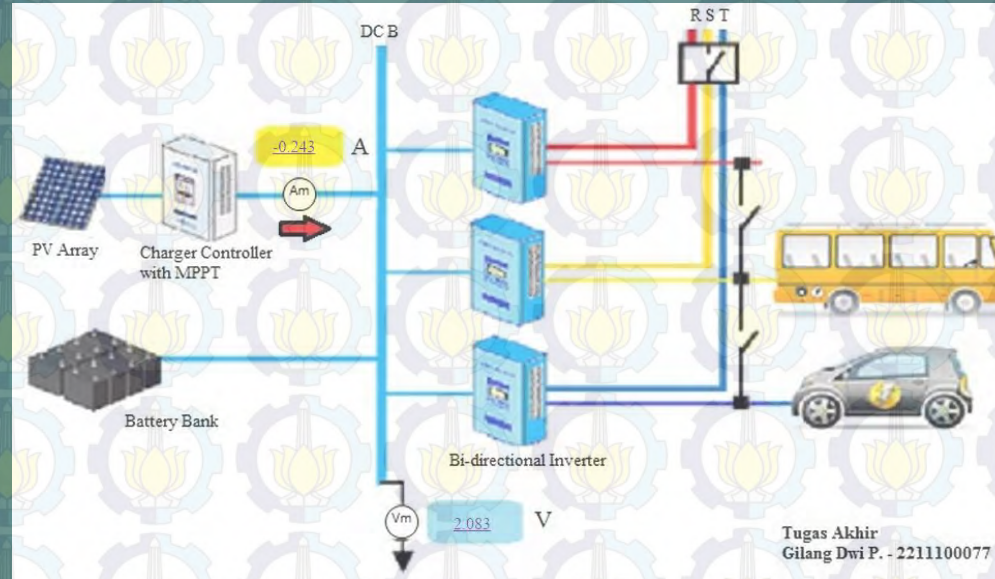

Pengujian Pada Sumber DC Lain (1)

Multimeter (V)	Hasil Pembacaan Mikrokontroller (V)	Error (%)
10.67	10.387	2.65
15.61	14.952	4.22
21.91	21.458	2.1
30.45	30.021	1.4
45.3	45.182	0.26
78	78.095	0.12
103.9	104.051	0.15
141.4	141.918	0.37
170.8	171.766	0.57
205.1	206.761	0.81
231	232.854	0.8
254.8	257.048	0.88
259.8	261.683	0.72

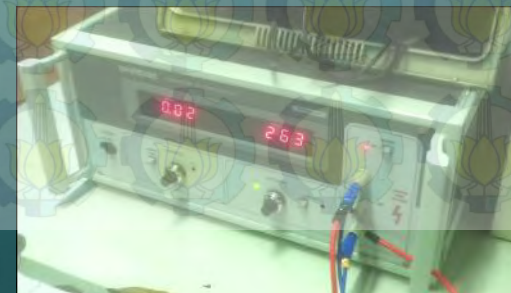
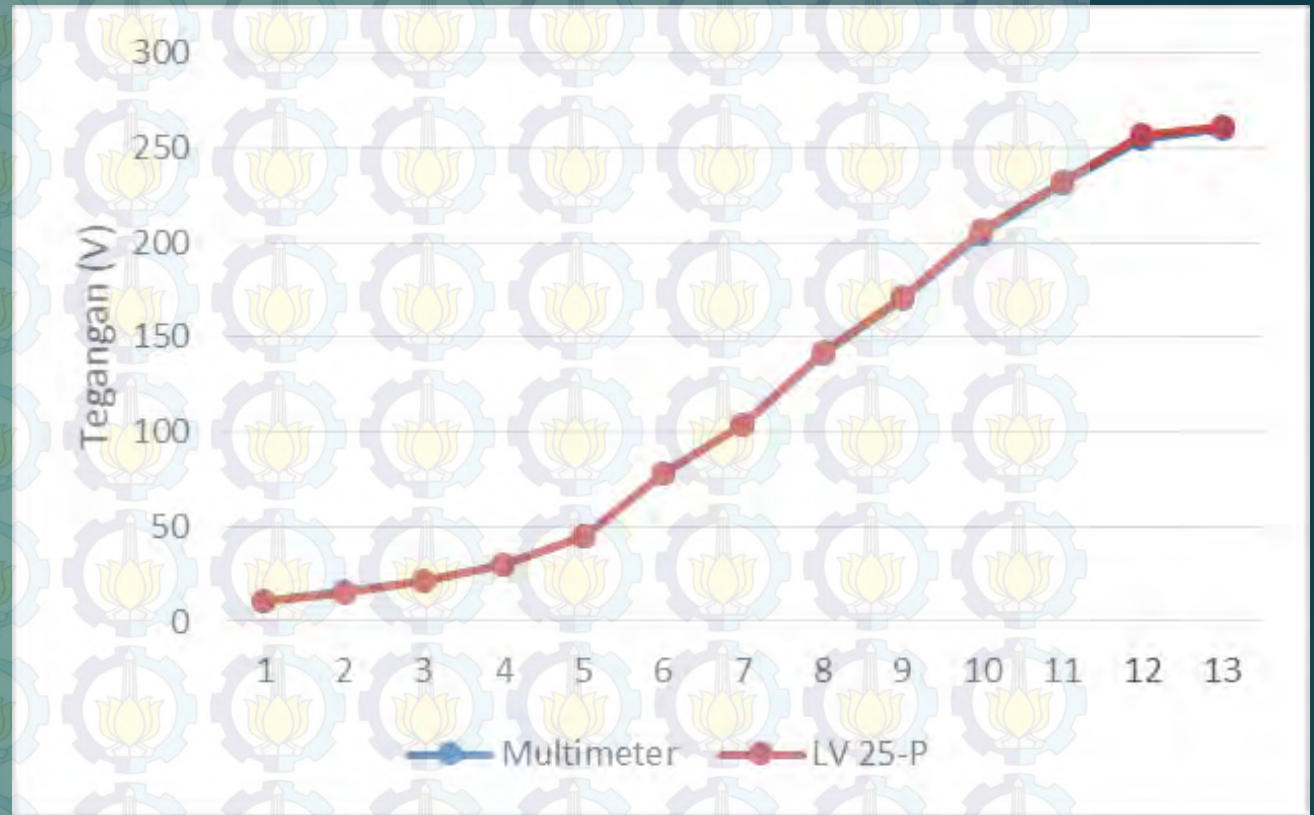

Pengujian Pada Sumber DC Lain (2)

Clamp meter (A)	Hasil Pembacaan Mikrokontroller (A)	Error (%)
1.5	1.304	13.0667
2.6	2.513	3.34615
3.7	3.696	0.10811
6.1	6.169	1.131148
8.7	8.872	1.977011
10.5	10.615	1.095238
11.9	12.115	1.806723
12.9	13.054	1.193798
-0.9	-1.061	17.88889
-3	-3.142	4.733333
-4.7	-4.96	5.531915
-6.2	-6.446	3.967742
-7.8	-7.994	2.487179
-9.8	-10.04	2.44898
-10.6	-10.79	1.792453
-11.9	-12.19	2.436975
-12.8	-12.94	1.09375

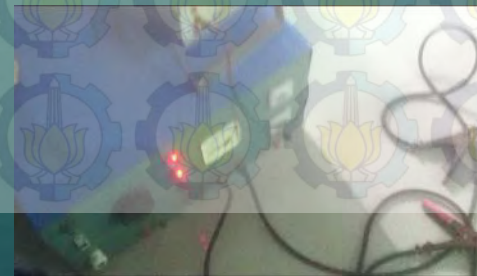
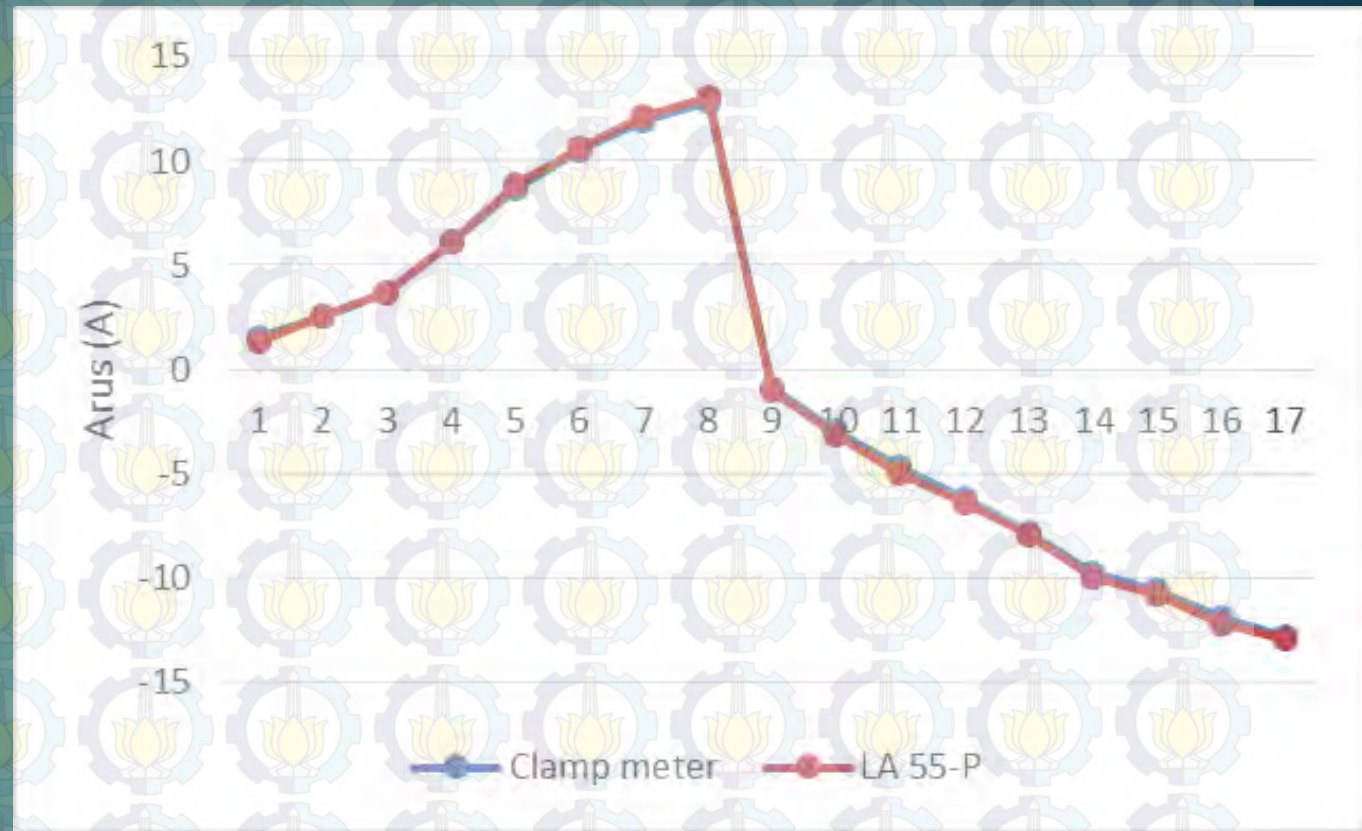

PENUTUP

- ▶ Kesimpulan
- ▶ Saran

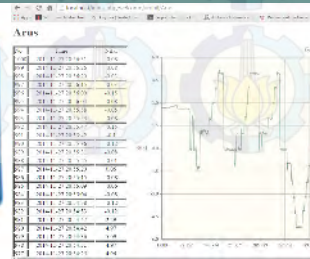
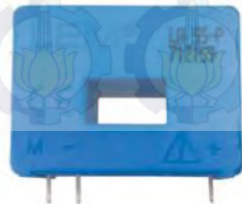

Kesimpulan

- ▶ Sistem monitoring yang telah disusun pada Tugas Akhir ini telah teruji dapat mengukur tegangan DC hingga 259.8 V dengan error 0.72% dan arus hingga 12.9 A dengan error 1.19%. Selama database server terkoneksi satu jaringan dengan modul ethernet berada, maka pengiriman data dari ethernet modul ke server dapat berlangsung, melalui protokol TCP/IP. Jika database server tidak on maka pengecekan nilai yang terukur dapat dilihat pada LCD 16x2.
- ▶ Data yang disimpan pada database server dibatasi hingga 1000 data terakhir. Dengan selang waktu pengiriman data ke database server setiap 10 detik. Tampilan pada web server berupa realtime nilai yang terukur pada saat itu juga, tabel 1000 data terakhir, dan grafik 1000 data terakhir.

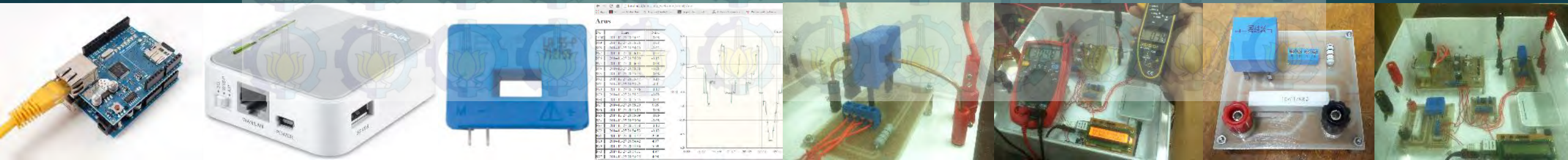

Saran

- ▶ Berdasarkan pengujian dan percobaan yang dilakukan oleh penulis, maka pengembangan lebih lanjut dari sistem ini ialah sistem database server yang tidak harus berada dalam satu jaringan dengan modul ethernet, tetapi dalam bentuk domain. Jadi koneksi mikrokontroler arduino dengan database server merupakan koneksi internet. Dengan begitu ethernet modul hanya perlu koneksi internet yang stabil untuk dapat mengirimkan datanya ke domain, tanpa harus ada sebuah server berupa komputer yang harus selalu on.

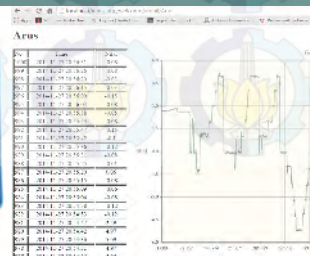
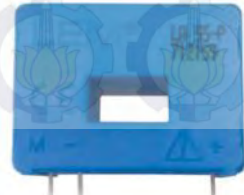

TERIMA KASIH

