



TUGAS AKHIR - MO184804

ANALISIS TEGANGAN PADA PIPA SAAT INSTALASI
DENGAN VARIASI *TENSION* DAN *RADIUS OF CURVATURE*
STUDI KASUS : PT PHE WMO

IDA BAGUS PUNDHARA SAKYANARY

NRP. 04311640000128

Dosen Pembimbing:

Ir. Imam Rochani, M.Sc

Ir. Handayanu, M.Sc, Ph.D.

DEPARTEMEN TEKNIK KELAUTAN

Fakultas Teknologi Kelautan

Institut Teknolgi Sepuluh Nopember

Surabaya

2020



FINAL PROJECT - MO184804

TENSION ANALYSIS OF PIPES DURING INSTALLATION
WITH TENSION AND RADIUS OF CURVATURE VARIATION
CASE STUDY: PT PHE WMO

IDA BAGUS PUNDHARA SAKYANARY

NRP. 04311640000128

SUPERVISOR

Ir. Imam Rochani, M.Sc

Ir. Handayanu, M.Sc, Ph.D.

DEPARTEMENT OF OCEAN ENGINEERING

Faculty of Marine Technology

Sepuluh Nopember Institute of Technology

Surabaya

2020

LEMBAR PENGESAHAN

**ANALISIS TEGANGAN PADA PIPA SAAT INSTALASI DENGAN
VARIASI *TENSION* DAN *RADIUS OF CURVATURE* STUDI KASUS : PT
PHE WMO TUGAS AKHIR**

Diajukan untuk memenuhi salah satu syarat memperoleh gelar Sarjana Teknik
(S.T) pada Program Studi S-1 Departemen Teknik Kelautan Fakultas Teknologi
Kelautan Institut Teknologi Sepuluh Nopember Surabaya

Oleh :

Ida Bagus Pundhara Sakyanary

04311640000128

Disetujui Oleh :

1. Ir. Imam Rochani, M.Sc

(Pembimbing 1)



2. Ir. Handayanu, M.Sc., Ph.D

(Pembimbing 2)



3. Nur Syahroni, S.T, M.T, Ph.D

(Penguji 1)

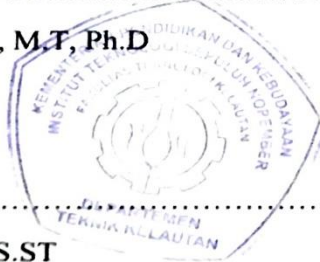

4. Dr. Dendy Satrio, S.ST

(Penguji 2)



Surabaya, Agustus 2020

ANALISIS TEGANGAN PADA PIPA SAAT INSTALASI DENGAN VARIASI TENSION DAN RADIUS OF CURVATURE STUDI KASUS : PT PHE WMO

ABSTRAK

Jalur pipa bawah laut merupakan jalur yang digunakan untuk mendistribusikan fluida baik dalam bentuk minyak, gas ataupun fluida lainnya. Metode distribusi fluida dengan menggunakan pipa sudah banyak digunakan di dunia industri minyak dan gas. Selain karena lebih murah, mendistribusikan fluida dengan menggunakan pipa bawah laut juga lebih praktis dibanding metode distribusi lainnya. Sebelum fluida dapat disalurkan dari fasilitas satu ke fasilitas lainnya, pipa harus melalui tahap instalasi terlebih dahulu. Instalasi biasanya dilakukan dengan menggunakan barge yang memiliki stinger pada bagian belakangnya, tergantung metode apa yang digunakan untuk instalasi. Salah satu bagian yang menentukan apakah pipa dapat terpasang dengan sempurna di dasar laut adalah tension pada tensioner. Karena, tension berfungsi untuk menjaga atau mengatur tegangan yang terjadi pada daerah kritis overbend dan sagbend agar tidak melewati batas kritis yang diijinkan. Maka dari itu tugas akhir ini menganalisa tentang berapa total tegangan terbesar yang terjadi pada pipa saat proses instalasi. Adapun beberapa variabel yang divariasikan adalah *tension* pada *tensioner* dan *radius of curvature*. Analisis yang dilakukan adalah analisis statis dan dinamis, dimana analisis statis dilakukan dengan kondisi *barge* dianggap diam dan dalam keadaan tidak ada gelombang, sedangkan analisis dinamis dilakukan dengan memasukan variabel RAO *Barge* dan spektrum gelombang yang akan dianalisis sesuai arah pembebanan seperti 0° , 45° , 90° , 135° , 180° . Hasil analisa statis S-Lay yang sudah dilakukan oleh penulis dengan variasi yang sesuai dengan *design case*. Dapat dilihat bahwa total tegangan yang paling besar terjadi adalah pada *case 6* dengan besar total tegangan sebesar 120,29 MPa atau sebesar 85,69 % dari SMYS. Pada *case ini* total stress masih dibawah nilai total stress yang diijinkan oleh DNV OS F101 yaitu harus dibawah 87% SMYS. Kemudian dilakukan permodelan barge dan didapatkan RAO dari barge tersebut, lalu dimasukan dalam analisis dinamis. Hasil analisis dinamis instalasi pipa dengan total tegangan dinamis maksimal terjadi pada *case 8* pada arah pembebanan 45° yaitu sebesar 254,16 Mpa atau setara 70,6% dari SMYS. *Codes* dan standart yang digunakan pada analisis statis dan dinamis instalasi pipa tersebut adalah DNV OS-F101 dengan stress criteria sebagai acuan batas total tegangan yang digunakan.

Kata Kunci : Instalasi pipa, *sagbend*, *overbend*, *stress*.

TENSION ANALYSIS OF PIPELINE INSTALLATION WITH TENSION AND RADIUS OF CURVATURE VARIATION CASE STUDY: PT PHE WMO

ABSTRACT

An underwater pipeline is a path used to distribute fluids in the form of oil, gas, or other fluids. Fluid distribution methods using pipes have been widely used in the oil and gas industry. Apart from being cheaper, distributing fluids using subsea pipelines is also more practical than other distribution methods. Before the fluid can be channeled from one facility to another facility, the pipe must go through the installation stage first. Installation is usually done by using a barge that has a stinger on the back, depending on what method is used for the installation. One part that determines whether the pipe can be installed perfectly on the seabed is the tension on the tensioner. Because tension serves to maintain or regulate the tension that occurs in the critical area of the overbend and sagbend so as not to cross the critical allowable limit. Therefore this thesis analyzes how much the maximum stress can be in the pipe during the installation process. Some of the varied variables are the tension on the tensioner and the radius of curvature. The analysis carried out is a static and dynamic analysis, where static analysis is done with the barge condition considered to be silent and in a state of no waves, while the dynamic analysis is done by entering the RAO Barge variable and the wave spectrum to be analyzed in the direction of loading such as 0o, 45o, 90o, 135o, 180o. The results of the static S-Lay analysis that have been done by the author with variations according to the design case. It can be seen that the greatest total stress occurs in case 6 with a total voltage of 120.29 MPa or 85.69% of SMYS. In this case, the total stress is still below the value of the total stress allowed by DNV OS F101 which must be under 87% of the SMYS. Then do a barge modeling and RAO obtained from the barge, then included in dynamic analysis. The results of dynamic analysis of pipe installations with maximum total dynamic stress occur in case 8 in the direction of load 45 ° which is equal to 254.16 Mpa or equal to 70.6% of SMYS. The codes and standards used in the static and dynamic analysis of the pipe installation are DNV OS-F101 with stress criteria as a reference to the total tension limit used.

Keywords : Pipeline installation, sagbend, overbend, stress.

KATA PENGANTAR

Puji dan syukur penulis panjatkan kehadirat Tuhan Yang Maha Esa karena berkat rahmat dan anugerah-Nya tugas akhir dengan judul : Analisis Tegangan Pada Pipa Saat Instalasi Dengan Variasi Tension dan Radius of Curvature Studi Kasus : PT PHE WMO dapat dirampungkan dengan baik. Tujuan dari pembuatan tugas akhir ini untuk memenuhi syarat memperoleh gelar Sarjana Teknik (S.T) bagi mahasiswa program S-1 program studi Teknik Kelautan Fakultas Teknologi Kelautan Institut Teknologi Kelautan.

Terima kasih saya ucapkan atas bantuan dari berbagai pihak yang telah dengan tulus berkontribusi dan membantu penulis menyelesaikan tugas akhir ini dengan baik. Besar harapan penulis semoga tugas akhir ini dapat menjadi acuan dan menambah wawasan bagi pembaca, untuk di kemudian hari dapat memperbaiki atau pun menyempurnakan tugas akhir ini.

Kritik dan saran sangat penulis harapkan sebab masih banyak keterbatasan dan kekurangan pengetahuan maupun pengalaman penulis.

Surabaya, Agustus 2020

UCAPAN TERIMA KASIH

Dalam penyusunan tugas akhir ini tidak lepas dari dukungan dan bantuan berbagai pihak. Penulis mengucapkan terima kasih yang sebesar-besarnya kepada seluruh pihak yang telah berkontribusi. Pada kesempatan ini penulis ingin mengucapkan banyak terima kasih kepada:

1. Ida Sang Hyang Widhi Wasa Tuhan Yang Maha Esa yang telah memberikan kekuatan dan menlacarkan semua proses yang penulis lalui dalam pengerjaan tugas akhir ini.
2. Kedua orang tua penulis yang dengan sabar dan tulus memberi semangat dan dukungan berupa nasihat dan materil selama proses tugas akkhir ini dibuat.
3. Bapak Ir. Imam Rochani, M.SC. dan bapak Ir. Handayanu, M.SC., Ph.D. yang telah bersedia membimbing dan memberikan saran selama masa pengerjaan tugas akhir ini.
4. Bapak Annas, Bapak Catur dan Ibu Nita sebagai pembimbing penulis yang telah memberi ilmu dan pengetahuan kepada penulis selama melakukan Kerja Praktik di PT PHE WMO sehingga melalui ilmu yang telah diberikan dapat menjadi acuan penulis dalam mengerjakan tugas akhir ini.
5. Jajaran dosen dan tenaga pendidik semua mata kuliah selama 4 tahun di Teknik Kelautan yang sudah memberi pelajaran berharga bagi penulis.
6. Bagas dan Amril yang senantiasa membantu penulis mulai dari masa Kerja Praktik bersama hingga penelitian ini selesai.
7. Teman-teman Angkatan ADHIWAMASTYA yang 4 tahun ini sudah dengan tulus memberi semangat dan masukan selama menghadapi perkuliahan, mengajarkan software, belajar bersama, berbagi cerita, dan kenangan selama 4 tahun kuliah.
8. Teman-teman BHISMA yang selama 4 tahun ini senantiasa membantu penulis beradaptasi di tanah rantau.
9. Teman-teman kontrakan “M1” yang telah menemani penulis mulai dari awal hingga akhirnya lulus bersama.
10. Ida Ayu Pratita Anjani sebagai penyemangat dalam suka maupun duka.
11. Seluruh pihak yang telah dengan tulus dan ikhlas membantu menyelesaikan tugas akhir ini, yang tidak bisa penulis sebutkan satu per satu.

DAFTAR ISI

ABSTRAK.....	iii
ABSTRACT.....	iv
KATA PENGANTAR	v
UCAPAN TERIMA KASIH.....	vi
DAFTAR GAMBAR	x
DAFTAR TABEL.....	xi
BAB I.....	1
PENDAHULUAN	1
1.1 Latar Belakang Masalah.....	1
1.2 Rumusan Masalah	2
1.3 Tujuan	2
1.4 Manfaat Penelitian.....	2
1.5 Batasan Masalah.....	3
1.6 Sistematika Penulisan.....	3
BAB II.....	4
TINJAUAN PUSTAKA	4
2.1 Tinjauan Pustaka	4
2.2 Dasar Teori.....	4
2.2.1 Pembebanan	4
2.2.2 Macam-macam Pembebanan.....	5
2.2.3 Beban Gelombang	5
2.2.4 Pipe Laying Barge.....	5
2.2.5 Teori Gerakan Bangunan Apung.....	7
2.2.6 <i>Response Amplitude Operator (RAO)</i>	8
2.2.7 Spektrum Gelombang.....	8
2.2.8 Spektrum Jonswap.....	8
2.2.9 Metode Instalasi Pipeline : S-Lay	9
2.2.10 Overbend.....	10
2.2.11 Sagbend.....	11
2.2.12 Perhitungan Berat Pipa Terendam.....	12
2.2.13 Allowable Stress Criteria	14
2.2.13 Metocean	17
2.2.14 Analisis Pipelaying.....	17

2.3 Tegangan Pada Pipa	17
2.3.1 Tegangan Normal.....	17
2.3.2 Tegangan Geser.....	19
2.3.3 Tegangan Von Mises.....	20
BAB III METODOLOGI PENELITIAN	21
3.1 Skema Diagram Alir.....	21
3.1.1 Menghitung Tegangan Pipa	21
3.2 Penjelasan Diagram Alir	23
BAB IV	25
ANALISA DAN PEMBAHASAN.....	25
4.1 Pengumpulan dan Identifikasi Data	25
4.1.1 Data Properti Pipa	25
4.1.2 Data Lapisan <i>Corrosion Coating</i> dan <i>Concrete Coating</i>	26
4.1.3 Data <i>Pipelaying Barge</i>	27
4.1.4 Data <i>Stinger</i>	27
4.1.5 Data <i>Roller</i> pada <i>Barge</i> dan <i>Stinger</i>	28
4.1.6 Data Lingkungan.....	29
4.2 Analisis statis S-Lay pada pipa saat instalasi	31
4.2.1 <i>Design Case Analisis Statis</i>	31
4.2.2 Hasil Analisis Statis S-Lay.....	32
4.3 validasi hasil tegangan	38
4.3.1 Tegangan Pada Tension 30 Ton dan Radius of Curvature 200 m.....	38
4.3.2 Tegangan Pada Tension 30 Ton dan Radius of Curvature 300 m.....	38
4.3.3 Tegangan Pada Tension 30 Ton dan Radius of Curvature 400 m.....	39
4.3.4 Tegangan Pada Tension 35 Ton dan Radius of Curvature 200 m.....	40
4.3.5 Tegangan Pada Tension 35 Ton dan Radius of Curvature 300 m.....	40
4.3.6 Tegangan Pada Tension 35 Ton dan Radius of Curvature 400 m.....	41
4.3.7 Tegangan Pada Tension 40 Ton dan Radius of Curvature 200 m.....	42
4.3.8 Tegangan Pada Tension 40 Ton dan Radius of Curvature 300 m.....	43
4.3.9 Tegangan Pada Tension 40 Ton dan Radius of Curvature 400 m.....	43
4.4 Permodelan Pipe Laying Barge.....	45
4.5 Analisis <i>Response Amplitudo Operator (RAO)</i>	49
4.5.1 Gerakan <i>Surge</i>	49
4.5.2 Gerakan <i>Sway</i>	50
4.5.3 Gerakan <i>Heave</i>	51
4.5.4 Gerakan <i>Roll</i>	51
4.5.5 Gerakan <i>Pitch</i>	52

4.5.6 Gerakan <i>Yaw</i>	53
4.6 Analisis Dinamis S-Lay pada Pipa saat Instalasi	53
4.6.1 <i>Design Case</i> Analisis Dinamis.....	55
4.6.2 Hasil Analisis Dinamis Total Tegangan Maksimal Arah 0°	56
4.6.3 Hasil Analisis Dinamis Total Tegangan Maksimal Arah 45°	59
4.6.4 Hasil Analisis Dinamis Total Tegangan Maksimal Arah 90°	62
4.6.5 Hasil Analisis Dinamis Total Tegangan Maksimal Arah 135°	65
4.6.6 Hasil Analisis Dinamis Total Tegangan Maksimal Arah 180°	68
BAB V PENUTUP	71
5.1 Kesimpulan	71
5.2 Saran	72
DAFTAR PUSTAKA	73
LAMPIRAN.....	75
LAMPIRAN A.....	76
LAMPIRAN B	139
LAMPIRAN C	147
BIODATA PENULIS	256

DAFTAR GAMBAR

Gambar 2.1 Pipe Laying Barge Tampak Atas-Plan View (Lee, 2009)	6
Gambar 2.2 Pipe Laying Barge Tampak Samping-Profile View (Lee, 2009).....	6
Gambar 2.3 Gerakan pada struktur terapung	8
Gambar 2.4 Proses Instalasi PipelineMetode S-lay	9
Gambar 2.5 Rigid Stinger (Yong Bai, 2001).....	10
Gambar 2.6 Tensioner dan Roller (Yong Bai, 2001)	10
Gambar 2.7 Model Catenary (Guo, 2014).....	12
Gambar 2.8 Hoop Stress pada pipa (Bai, 2014)	15
Gambar 2.9 Faktor yang memengaruhi Longitudinal Stress pada pipa (Bai, 2014)	16
Gambar 2.10 Pembebanan Aksial Pada Batang Tubular.....	18
Gambar 3.1 Diagram alir metodologi penelitian	21
Gambar 3.2 Diagram alir metodologi penelitian	22
Gambar 4.1 Peta Jalur Pipa 6” CPP2 ke PHE-12	25
Gambar 4.2 Peta Wilayah Kerja PT. PHE WMO	29
Gambar 4.3 Grafik Total Tegangan pada Tension 30 ton.	33
Gambar 4.4 Grafik Total Tegangan pada Tension 35 ton.	34
Gambar 4.5 Grafik Total Tegangan pada Tension 40 ton.	35
Gambar 4.6 Permodelan Barge pada MOSES.....	45
Gambar 4.7 Permodelan Barge Tampak Isometric	45
Gambar 4.8 Permodelan Barge Tampak Samping	46
Gambar 4.9 Permodelan Barge Tampak Atas	46
Gambar 4.10 Permodelan Barge Tampak Bow.....	47
Gambar 4.11 Permodelan Mooring Barge Tampak Isometri	47
Gambar 4.12 Permodelan Mooring Barge Tampak Samping	48
Gambar 4.13 Permodelan Mooring Barge Tampak Atas	48
Gambar 4.14 Permodelan Mooring Barge Tampak Bow	49
Gambar 4.15 Grafik RAO Gerakan Surge	49
Gambar 4.16 Grafik RAO Gerakan Sway.....	50
Gambar 4.17 Grafik RAO Gerakan Heave.....	51
Gambar 4.18 Grafik RAO Gerakan Roll.....	51
Gambar 4.19 Grafik RAO Gerakan Pitch.....	52
Gambar 4.20 Grafik RAO Gerakan Yaw	53
Gambar 4.21 Distribusi Total Tegangan Dinamis Maksimal Arah 0°	56
Gambar 4.22 Kurva S-Lay Dinamis arah 0°	56
Gambar 4.23 Distribusi Total Tegangan Dinamis Maksimal Arah 45°	59
Gambar 4.24 Kurva S-Lay Dinamis Arah 45°	59
Gambar 4.25 Distribusi Total Tegangan Dinamis Maksimal Arah 90°	62
Gambar 4.26 Kurva S-Lay Dinamis Arah 90°	62
Gambar 4.27 Distribusi Total Tegangan Dinamis Maksimal Arah 135°	65
Gambar 4.28 Kurva S-Lay Dinamis Arah 135°	65
Gambar 4.29 Distribusi Total Tegangan Dinamis Maksimal Arah 180°	68

Gambar 4. 30 Kurva S-Lay Dinamis Arah 180°	68
---	----

DAFTAR TABEL

Tabel 4. 1 Data Properti Pipa	25
Tabel 4. 2 Data Berat Pipa	26
Tabel 4. 3 Data Pressure Pipa.....	26
Tabel 4. 4 Data Tebal Lapisan Pipa	26
Tabel 4. 5 Data Sacrificial Anode Pipa	26
Tabel 4. 6 Ukuran Dimensi Barge.....	27
Tabel 4. 7 Data Tensioner pada Barge	27
Tabel 4. 8 Data Jenis Stinger yang digunakan	27
Tabel 4. 9 Konfigurasi Roller Support pada Barge	28
Tabel 4. 10 Konfigurasi Roller Support pada Stinger	28
Tabel 4. 11 Data Arus 1 Tahunan.....	30
Tabel 4. 12 Data arus 10 Tahunan.....	30
Tabel 4. 13 Data Parameter Air Laut	30
Tabel 4. 14 Data Tanah	31
Tabel 4. 15 Kedalaman Pipa	31
Tabel 4. 16 Design Case Analisis Statis.....	32
Tabel 4. 17 Perintah yang digunakan untuk Analisis Statis	32
Tabel 4. 18 Hasil Total Tegangan daerah Overbend Pada Tension 30 ton	33
Tabel 4. 19 Hasil Total Tegangan daerah Overbend Pada Tension 35 ton	34
Tabel 4. 20 Hasil Total Tegangan daerah Overbend pada Tension 40 ton.	35
Tabel 4. 21 Hasil Analisis Statis Instalasi S-Lay	36
Tabel 4. 23 Ringkasan hasil regangan statis.....	37
Tabel 4. 24 Variabel yang Digunakan untuk Analisis Dinamis	54
Tabel 4. 25 Variabel Durasi dan Interval Waktu Analisis Dinamis	54
Tabel 4. 26 Design case analisis dinamis	55
Tabel 4. 27 Hasil Analisis Dinamis Tegangan Arah 0°	57
Tabel 4. 28 Hasil Analisis Dinamis Regangan Arah 0°	58
Tabel 4. 29 Hasil Analisis Dinamis Tegangan Arah 45°	60
Tabel 4. 30 Hasil Analisis Dinamis Regangan Arah 45°	61
Tabel 4. 31 Hasil Analisis Dinamis Tegangan Arah 90 °	63
Tabel 4. 32 Hasil Analisis Dinamis Regangan Arah 90°	64
Tabel 4. 33 Hasil Analisis Dinamis Tegangan Arah 135°.....	66
Tabel 4. 34 Hasil Analisis Dinamis Regangan Arah 135°	67
Tabel 4. 35 Hasil Analisis Dinamis Tegangan Arah 180°.....	69
Tabel 4. 36 Hasil Analisis Dinamis Regangan Arah 180°	70

BAB I PENDAHULUAN

1.1 Latar Belakang Masalah

Offshore pipeline atau jalur pipa bawah laut merupakan jalur yang digunakan untuk menyalurkan fluida dalam bentuk minyak, gas, atau fluida lainnya. Menyalurkan fluida dengan pipa sudah banyak digunakan dalam perindustrian minyak dan gas di masa modern ini. Selain karena lebih murah, mendistribusikan fluida dengan menggunakan pipa bawah laut juga lebih praktis dibanding metode distribusi lainnya. Sebelum fluida dapat disalurkan dari fasilitas satu ke fasilitas lainnya, pipa harus melalui tahap instalasi terlebih dahulu. Instalasi biasanya dilakukan dengan menggunakan barge yang memiliki stinger pada bagian belakangnya, tergantung metode apa yang digunakan untuk instalasi. Instalasi merupakan salah satu kegiatan penting yang dilakukan setelah proses desain. Ada banyak metode yang digunakan pada proses instalasi antara lain metode S-Lay, J-lay, Reel Lay dan Tow-in. Menurut *offshore pipeline* (2005), S-lay aman dilakukan pada kedalaman kurang dari 500 *feet*, J-Lay antara 500 – 1000 *feet* dan reel lay biasanya antara intermediate sampai deep water yaitu kedalaman yang mencapai lebih dari 1000 *feet*. Selain tergantung dari kedalaman yang perlu mendapat perhatian juga adalah kondisi lingkungan dimana pipa akan diinstalasi seperti : angin, arus, dan gelombang yang akan berpengaruh pada perilaku dinamis Lay Barge, dan ini akan berdampak terhadap kegagalan pipa. Model kegagalan yang sangat signifikan pengaruhnya adalah *buckling* dan *collapse*. Addy (2006) dalam penelitiannya menemukan bahwa gerakan tunggal yang memiliki kontribusi terbesar terhadap tegangan pipa adalah gerakan pitch sebesar 98.56%. Dalam proses instalasi juga diperlukan analisa dinamis, dimana pada penelitian Handono (2007) yang memfokuskan pada analisa beban dinamis menghasilkan bahwa tegangan maksimum pipa mempengaruhi stabilitas pipa pada dasar laut. Lain halnya dengan Aristanto (2007) yang meneliti bahwa variasi tegangan *bending* yang diakibatkan oleh perbedaan kedalaman saat proses instalasi *offshore pipeline* merupakan hal penting lainnya yang membutuhkan analisa kompleks. Bicara soal dunia kontruksi lepas pantai pastinya tak jauh dengan gaya hidrodinamika yang akan diterima oleh struktur, seperti dalam penelitian Makisang (2007) menemukan bahwa gaya hidrodinamika sangat mempengaruhi segala jenis pekerjaan bawah laut seperti instalasi pipeline. Maka, penelitian mengenai tegangan yang terjadi pada pipa saat proses instalasi *offshore pipeline* sangatlah penting untuk menghindari *buckling*. Seperti pada penelitian Rizaldy (2008) yang meneliti bahwa pipa dengan spesifikasi bahan tertentu akan mengalami buckling jika terjadi tegangan yang berlebih. Ada beberapa bahan yang digunakan untuk membuat *offshore pipeline*, salah satunya adalah polyethylene. Sedangkan, dalam penelitian Khanifudin (2015) mengatakan bahwa jika tegangan yang diakibatkan oleh bentangan bebas melebihi batas *ultimate*-nya akan menyebabkan *buckling* pada pipa.

Dari penelitian-penelitian yang telah dilakukan terlihat bahwa tegangan dan regangan merupakan faktor utama dalam kerusakan yang terjadi pada pipa saat instalasi berlangsung. Sebenarnya tegangan dan regangan saat proses instalasi bisa kita kendalikan dengan beberapa alat bantu seperti tensioner dan stinger yang terletak pada pipe laying barge. Namun konfigurasi stinger dan besaran tension yang optimal diperlukan untuk menjaga tegangan dan regangan yang terjadi pada pipa saat proses instalasi berlangsung. Pada tugas akhir ini penulis akan menganalisis tegangan pada pipa saat instalasi dengan variasi tension dan radius of curvature.

1.2 Rumusan Masalah

Dalam tugas akhir ini terdapat beberapa permasalahan yang akan dikaji antara lain sebagai berikut :

1. Berapa nilai tegangan terbesar yang dialami pipa pada daerah kritis *overbend* dan *sagbend* saat instalasi dengan kondisi statis dengan variasi *tension* dan *radius of curvature*?
2. Berapa nilai tegangan terbesar yang dialami pipa pada daerah kritis *overbend* dan *sagbend* saat instalasi dengan kondisi dinamis dengan variasi *tension* dan *radius of curvature*?
3. Berapa nilai tension optimal yang diperlukan pada proses instalasi pipa dengan diameter 6.625 inch?

1.3 Tujuan

Dari rumusan masalah diatas, dapat diambil tujuan yang ingin dicapai pada tugas akhir ini adalah :

1. Mengetahui nilai tegangan dan regangan terbesar yang terjadi pada pipa di daerah kritis *overbend* dan *sagbend* saat instalasi dengan kondisi dinamis.
2. Menganalisa besar tension yang diperlukan pada tiap daerah (saat pipa berada di *laybarge*, *stinger*, *sagbend*, *overbend*).
3. Mengetahui nilai tension minimal yang digunakan untuk instalasi pipa dengan kondisi lingkungan yang berlaku.

1.4 Manfaat Penelitian

Manfaat dari tugas akhir ini antara lain :

1. Bagi IPTEK penelitian ini dapat menjadi bahan pengembangan ilmu pengetahuan dibidang teknologi kelautan tentang proyek instalasi jalur pipa bawah laut.
2. Memberi pemahaman kepada peneliti dan pembaca mengenai pengaruh besaran tension terhadap tegangan dan regangan yang terjadi pada pipa bawah laut serta mengetahui hasil analisa yang diharapkan dapat menjadi acuan dalam menghitung stabilitas dan tegangan maksimum pipa bawah laut khususnya pada kondisi statis dan dinamis.

1.5 Batasan Masalah

Batasan masalah dalam penelitian ini adalah sebagai berikut :

1. Metode instalasi *pipeline* menggunakan metode S-Lay.
2. Data yang digunakan pada penelitian ini adalah data milik PT PHE WMO.
3. Profil dasar laut dianggap datar.
4. Beban lingkungan yang dianalisa adalah beban gelombang dan beban arus.
5. Arah sudut datang beban gelombang diasumsikan pada 0° , 45° , 90° , 135° , 180° .
6. Analisa dilakukan pada pipa berdiameter 6.625 inch.
7. Analisis instalasi pipa S-Lay dan permodelan pipe laying barge menggunakan software OFFPIPE dan MOSES.
8. Code yang digunakan cek tegangan maksimum yang diijinkan adalah DNV OS F-101 mengenai Rules for Submarine Pipeline System.

1.6 Sistematika Penulisan

Bab I : Pendahuluan

Dalam bab ini menjelaskan tentang latar belakang masalah yang diangkat dalam tugas akhir, perumusan masalah, tujuan yang ingin dicapai, manfaat penelitian, batasan masalah, dan sistematika penulisan tugas akhir.

Bab II : Tinjauan Pustaka dan Dasar Teori

Bab ini terdiri dari tinjauan pustaka yang membahas tentang penelitian yang digunakan sebagai referensi dan acuan dalam penulisan tugas akhir dan penjelasan mengenai dasar teori yang dipakai dalam penulisan.

Bab III : Metodologi Penelitian

Menjelaskan tentang alur pengerjaan tugas akhir ini.

BAB IV : Hasil dan Pembahasan

Merupakan pembahasan dari hasil analisa-analisa yang telah dilakukan pada penelitian, meliputi analisa hasil, dan pembahasan hasil analisa.

BAB II TINJAUAN PUSTAKA

2.1 Tinjauan Pustaka

Offshore pipeline memiliki metode pemasangan yang berbeda-beda sesuai kondisi lingkungan yang berlaku di lokasi pemasangan. Untuk perairan dangkal, metode pemasangan yang sering dipakai adalah metode S-lay yaitu pada kedalaman dengan katagori *shallow water* hingga *deep water*. Sedangkan untuk metode pemasangan J-lay digunakan untuk kedalaman dengan katagori *intermediate water* hingga *deepwater water* untuk meminimalisir tegangan yang terjadi. Yang dimaksud *shallow water* adalah laut dari garis pantai hingga kedalaman 500 feet, *intermediate water* adalah perairan dengan kedalaman 500-1000 feet, sedangkan untuk *deepwater* adalah perairan yang kedalamannya diatas 1000 feet (Guo *et al*, 2014).

Istilah pipeline diartikan sebagai bentangan pipa fluida dengan jarak yang sangat panjang. Komoditas yang sering ditransportasikan adalah air, gas alam, minyak mentah, dan produksi hasil pengolahan minyak bumi lainnya, pipeline digunakan dalam berbagai macam tujuan salah satu diantaranya adalah sebagai trunk line yakni mengangkut minyak dan/atau gas dari fasilitas produksi menuju daratan (Mouselli, 1981).

Zaki (2019) telah menganalisis proses *initiation* dan *laydown* saat proses instalasi *pipeline* menunjukkan bahwa *stress* dan *strain* yang terjadi tidak melebihi kriteria yang ditetapkan oleh DNV OS F101 baik dalam kondisi statis dan dinamis. Namun beliau juga menambahkan bahwa masih diperlukan analisis besaran tension yang dibutuhkan saat proses instalasi untuk mencari besaran tension yang optimal.

Berdasarkan penelitian-penelitian yang sudah dilakukan sebelumnya, penulis mengajukan penelitian mengenai analisis tegangan pada pipa saat instalasi dengan variasi *tension* dan *radius of curvature* studi kasus PT. PHE WMO.

2.2 Dasar Teori

2.2.1 Pembebanan

Sepanjang umur operasi pipa bawah laut, ada 4 jenis kondisi pembebanan, antara lain :

1. Instalasi

Beban yang bekerja pada pipa saat kondisi ini antara lain : beban gelombang dan beban arus serta beban dari berat pipa itu sendiri. Tegangan yang terjadi pada kondisi ini dipengaruhi oleh metode instalasi yang digunakan.

2. *Hydrotest*

Hydrotest dilakukan untuk menguji kekuatan pipa dengan memberikan tekanan yang besar ke dalam pipa. Beban yang mempengaruhi adalah

tekanan dalam pipa (internal pressure) dan tentunya berat pipa yang bertambah akibat adanya air laut.

3. Operasi

Setelah insstalasi dan hydrotest, selanjutnya adalah fase operasi, dimana pipa mulai digunakan untuk menyalurkan fluida yang ditentukan. Tekanan dalam serta temperature yang sangat tinggi akan mempengaruhi formasi dan tegangan pada pipa.

2.2.2 Macam-macam Pembebanan

1. *Functional load*

Beban fungsional atau *functional load* merupakan beban yang bekerja pada pipa akibat dari keberadaan pipa itu sendiri tanpa dipengaruhi oleh beban lingkungan. Termasuk beban struktur baja pipa, berat lapisan anti korosi, lapisan concrete coating, beban akibat tekanan dalam yang diberikan pada pipa, beban suhu yang tinggi, dan beban sisa instalasi.

2. *Enviromental Load*

Beban yang bekerja pada pipa akibat kondisi lingkungan di sekitar pipa. Untuk pipa bawah laut, beban yang mempengaruhi adalah gelombang dan arus. Data lingkungan yang didapatkan pastinya bersifat acak, maka data yang digunakan untuk analisa adalah data periode ulang.

2.2.3 Beban Gelombang

Gelombang laut terbentuk dari permukaan laut yang terkena hembusan angin secara terus menerus. Besarnya gelombang tergantung dari intensitas, jangka waktu, jarak angin berhembus. Gelombang menyerap energi dari angin, lalu menyalurkan energi untuk penyebaran. Beban gelombang ditimbulkan oleh beban lingkungan pada struktur lepas pantai.

2.2.4 Pipe Laying Barge

Pipe Laying Barge adalah salah satu jenis *vessel* yang biasa digunakan karena efektif dalam proses instalasi *pipeline* di lepas pantai. *Pipe laying barge* (PLB) merupakan tipe *vessel* yang memiliki kemampuan instalasi *pipeline* di lepas pantai mulai dari kedalaman 15 meter hingga kedalaman lebih dari 1000 m (Bai. 2001).

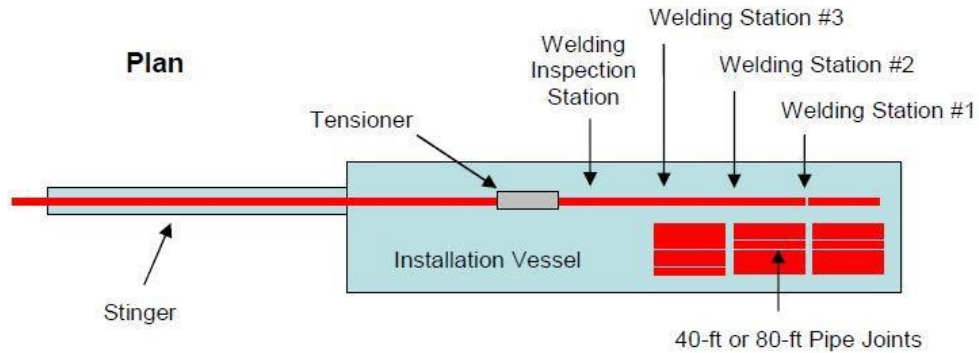

Gambar 2.1 *Pipe Laying Barge* Tampak Atas-Plan View (Lee, 2009)

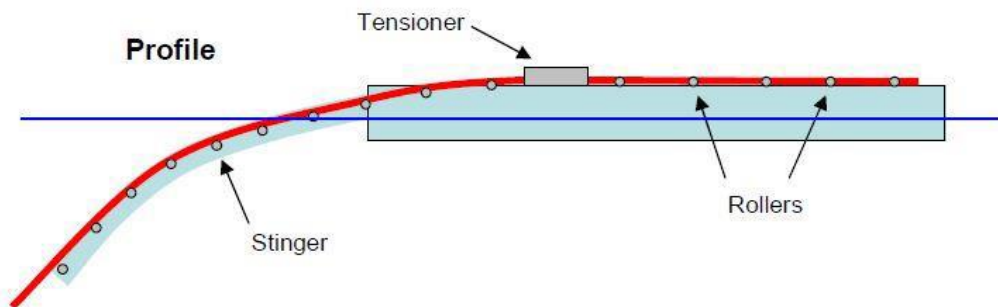

Gambar 2.2 *Pipe Laying Barge* Tampak Samping-Profile View (Lee, 2009)

Alur operasi instalasi pipa penyalur bawah laut dimulai dari kegiatan pengangkatan pipa atau *pipe hauling* dari lokasi *stockpipe* di penyimpanan pipa di darat, umumnya diangkut dengan *Pipe Haul Barge* (PHB) jenis *ballastable flat top barge* dan ditarik kapal tunda ke lokasi *Pipe Laying Barge* (PLB). Sesampainya di lokasi *Pipe Laying Barge*, pipa-pipa dipindahkan dengan *crane Pipe Laying Barge* ke dek *Pipe Laying Barge* untuk dipersiapkan dalam kegiatan pengelasan.

Pada operasi instalasi *pipeline* di lepas pantai, *pipe joint* sepanjang 12.2 m diangkut ke *Pipe Laying Barge* dengan menggunakan *vessel crane*. Pada instalasi *pipeline* dengan menggunakan *Pipe Laying Barge*, *pipeline* difabrikasi diatas *barge* di *firing line*. Biasanya *Pipe Laying Barge* memiliki *firing line* dengan 3 *station* untuk proses *pipeline welding*, 1 *station welding* NDT dan reparasi dan 1 *station* untuk *Field Joint coating*. Saat proses instalasi berlangsung, *lay barge* bergerak maju dan pada saat yang bersamaan *pipeline* melalui proses fabrikasi di *firing line* dan perlahan digerakkan menuju *stinger* dibagian buritan kapal, lalu meluncur

perlahan melalui *stinger* ke dasar laut. Ilustrasi *Pipe Laying Barge* dapat dilihat pada Gambar 2.1 dan Gambar 2.2 diatas.

Pipelaying barge digunakan karena kedalaman laut pada lokasi instalasi pipa pada tugas akhir ini berada pada kedalaman antara 55 meter sampai dengan 56 meter yang termasuk dalam perairan dangkal atau *shallow water* yang mencakup pantai hingga kedalaman 1000 meter. Sedangkan *pipelaying vessel* digunakan untuk instalasi pipa bawah laut yang kedalaman lautnya diatas 1000 meter.

2.2.5 Teori Gerakan Bangunan Apung

Sebuah kapal atau bangunan apung yang sedang dalam kondisi operasinya akan mengalami gerakan akibat pengaruh gelombang. Respon gerakan yang diberikan kapal terhadap gelombang ini yang nantinya perlu diperhatikan untuk memahami posisi kapal saat operasi. Umumnya Gerakan dari kapal yang terpengaruh gaya gelombang dapat dibagi menjadi dua macam yaitu Gerakan translasi dan Gerakan rotasi. Jika mengacu pada Society of Naval Architects and Marine Engineers (1989) gerakan translasi terbagi menjadi 2 dan bisa juga dilihat pada Gambar 2.3 di bawah :

1. Heave, gerakan keatas/kebawah yang bertumpu pada sumbu z
2. Sway, gerakan ke kanan/kiri yang bertumpu pada sumbu y
3. Surge, gerakan longitudinal maju/mundur yang bertumpu pada sumbu x

Sedangkan gerakan rotasi terbagi menjadi :

1. Roll, gerakan memutar secara longitudinal terhadap sumbu x
2. Pitch, gerakan rotasi secara transversal terhadap sumbu y
3. Yaw, gerakan rotasi menyamping terhadap sumbu z

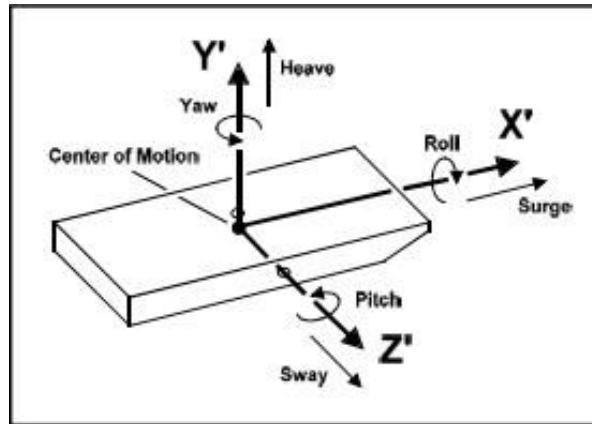

Gambar 2.3 Gerakan pada struktur terapung

2.2.6 Response Amplitude Operator (RAO)

Response amplitude operator (RAO) merupakan faktor pengali dari respon struktur akibat gelombang yang mengenai struktur lepas pantai pada frekuensi tertentu. RAO juga merupakan alat untuk mentransfer beban luar (gelombang) dalam bentuk respon pada suatu struktur. RAO dapat didefinisikan sebagai :

$$RAO = \frac{\zeta(x,y,z)}{\zeta_0} \quad (2.1)$$

Dimana $\zeta(x, y, z)$ adalah amplitude gerakan struktur terhadap 6 derajat kebebasan dan ζ_0 adalah amplitude gelombang.

2.2.7 Spektrum Gelombang

Pemilihan spektrum gelombang diperlukan dalam menganalisis gerakan barge saat instalasi pipa, dimana spektrum gelombang yang dipilih harus sesuai dengan tempat dimana dilaksanakannya instalasi. Setiap spektrum gelombang memiliki karakteristiknya masing-masing sesuai dengan keadaan asli perairan tersebut.

2.2.8 Spektrum Jonswap

Pada tahun 1973, Hasselman telah menganalisis data yang dikumpulkan pada proyek *Joint North Sea Wave Observation Project (JONSWAP)* menghasilkan bahwa spektrum gelombang tidak pernah sepenuhnya berkembang. Spektrum mulai mengalami perkembangan melalui persamaan non-linier, dimana interaksi yang terjadi antar gelombang untuk waktu dan jarak yang lama sehingga perlu diberi factor *artificial* atau buatan ke persamaan *pierson-moskowitz* untuk memperbaiki

pengukurannya. Oleh karena itu, disusunlah persamaan matematis yang merupakan modifikasi dari spectra pierson-moskowitz yang dapat digunakan pada perairan yang tertutup atau kepulauan. Berikut merupakan persamaan spektrum JONSWAP menurut DNV RP C205 :

$$S(\omega) = \alpha g^2 \omega^{-5} \exp \left[-1,25 \left(\frac{\omega}{\omega_0} \right)^{-4} \right] \gamma \exp \left[-\frac{(\omega - \omega_0)^2}{2r^2 \omega_0^2} \right] \quad (2.2)$$

2.2.9 Metode Instalasi Pipeline : S-Lay

Setelah ditemukan metode instalasi pipa dengan cara *offshore pipelaying* telah ada tiga metode yang umum dipakai dalam konstruksi *pipeline* yaitu metode S-Lay, J-Lay dan *Reeling*. Konsep utama dari semua metode instalasi ini adalah untuk menjaga agar *bending* dan *axial stress* yang terjadi pada *pipeline* tetap berada pada batas yang diperbolehkan (Guo, 2014). Metode S-Lay biasa digunakan untuk menginstalasi pipa yang berada pada kedalaman dangkal maksimum 500 ft. Metode S-Lay dinamakan demikian karena posisi pipa saat di instalasi membentuk huruf S. Pada saat proses laying dibutuhkan *stinger* untuk mengontrol *bending* bagian atas dan *tensioner* untuk mengontrol *bending* bagian bawah. Untuk perairan dalam membutuhkan *stinger* yang lebih panjang dan *tensioner* yang lebih kuat. Ilustrasi instalasi dengan metode S-Lay dapat dilihat pada Gambar 2.3 dibawah.

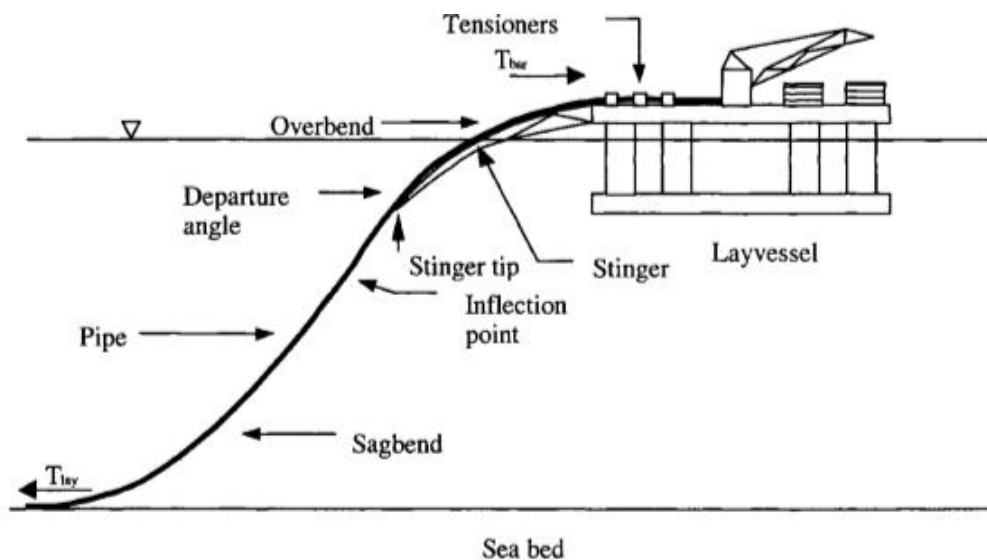

Gambar 2. 4 Proses Instalasi Pipeline Metode S-lay

Pada instalasi metode S-Lay dengan menggunakan *laying barge* terdapat beberapa peralatan yang mendukung proses instalasi yaitu :

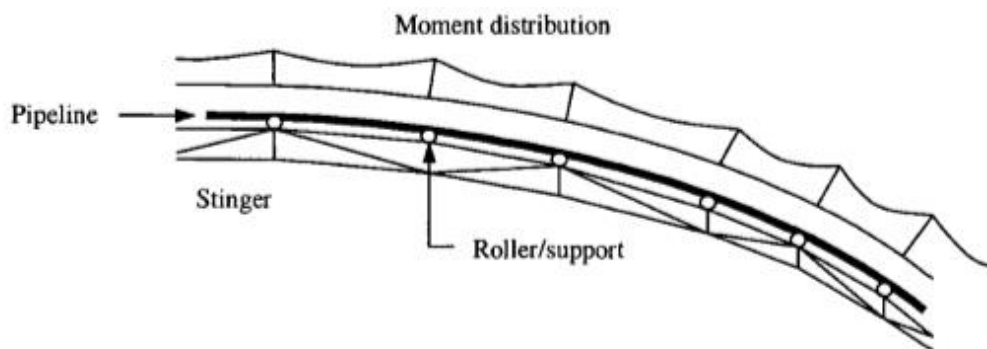

Gambar 2. 5 Rigid Stinger (Yong Bai, 2001)

-*Stinger* adalah alat bantu instalasi pada *laying barge* yang berbentuk *open frame structure* dan dilengkapi dengan *roller* seperti yang dapat dilihat pada Gambar 2.4 diatas. Konfigurasi *roller* dan sudut dari *stinger* ini mempengaruhi tegangan pada *pipeline* pada bagian *overbend*.

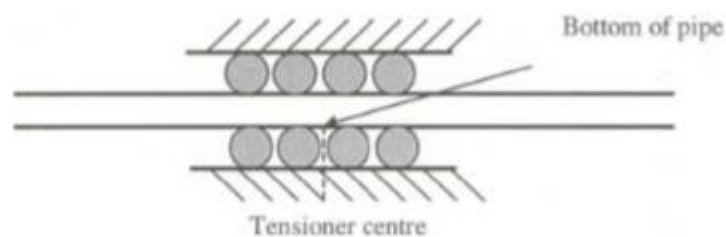

Gambar 2. 6 Tensioner dan Roller (Yong Bai, 2001)

-*Tensioner* merupakan alat yang menentukan besarnya kapasitas *tension* dari suatu *lay barge*. *Tensioner* merupakan yang terdiri dari *roller track* yang dilengkapi dengan *pads* seperti yang dapat dilihat pada Gambar 2.5 diatas. *Tensioner* ini juga berfungsi mengatur *payout speed* (Up) dari *pipeline* yang telah siap untuk diluncurkan dari *stinger* dengan menjaga *tension* dari *pipeline* tersebut.

2.2.10 Overbend

Overbend merupakan titik kritis akibat tegangan total yang dipengaruhi oleh konfigurasi *roller support* dan sudut kemiringan *stinger*. Bagian ini di *support* oleh *laying ramp* yang berbentuk *roller* yang dipasang pada *stinger*. Fungsi dari *laying*

ramp yaitu untuk memberikan *curved support* dengan radius kurvatur yang sesuai, yang digunakan untuk mengatur *over bending stress* dan *strain* pada *pipeline* dalam *range* nilai yang di izinkan. Radius kurvatur *pipeline* pada *overbend* sebagian besar diatur oleh *stinger*. Gabungan antara kurvatur dan *axial tension* menyebabkan terjadinya tegangan global pada *pipeline* di *overbend*. Tegangan lokal pada bagian *overbend* ini terjadi pada *roller* yang menopang *pipeline* dan diasumsikan berupa beban titik pada *pipeline* (Guo dkk.2005).

Bending stress pada *overbend* dapat dihitung dengan formula berikut :

$$\sigma_a = \frac{ED}{2R_{cv}} \quad (2.3)$$

Dengan,

σ_a = Axial Bending Stress

E = Steel Young's Modulus

D = Pipeline Outside Diameter

R_{cv} = Pipeline Radius of Curvature

Sehingga nilai dari minimum *radius of curvature* dapat ditentukan dengan formula berikut :

$$R_{cv} = \frac{ED}{2\sigma_y f_D} \quad (2.4)$$

Dengan,

σ_y = SMYS

f_D = Design Factor, 0.85

2.2.11 Sagbend

Di daerah *sagbend* titik belok (*inflection point*) tidak dapat diketahui. Karena titik belok (*inflection point*) tidak dapat diketahui maka *tension* yang terjadi pada *sagbend* dapat diperkirakan dengan menentukan nilai *departure angle* dan jarak dari *seabed* terhadap ujung *stinger*. Pada *sagbend*, karena pengaruh beban gabungan antara *tension* dan berat *pipeline* itu sendiri, *pipeline* mengalami defleksi besar dari keadaan *stress free* sebelumnya. Untuk model *catenary* bisa dilihat pada Gambar 2.7 di bawah.

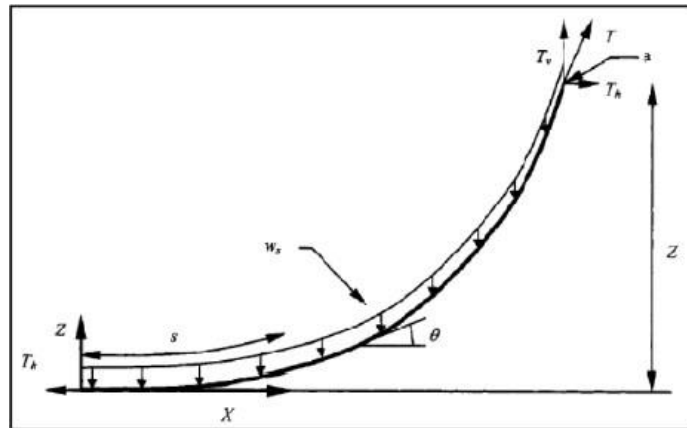

Gambar 2. 7 Model Catenary (Guo, 2014)

2.2.12 Perhitungan Berat Pipa Terendam

Perhitungan berat pipa saat terendam atau tercelup sangat diperlukan untuk menentukan kebutuhan tension pada tensioner. Tiap-tiap lapisan pipa tersebut memiliki berat sendiri sesuai dengan massa jenis masing-masing lapisan dan ukurannya. Untuk mengetahui berat pipa, luasan pipa perlu diketahui terlebih dahulu, oleh karena itu sangat diperlukan perhitungan diameter tiap tiap lapisan menggunakan persamaan dibawah ini,

$$D_i = OD - 2 \cdot WT \quad (2.5)$$

$$D_{cc} = OD + 2 \cdot t_{cc} \quad (2.6)$$

$$D_{conc} = D_{cc} + 2 \cdot t_{conc} \quad (2.7)$$

$$D_{fj} = OD + 2 \cdot t_{cc} + 2 \cdot t + t_{fj} \quad (2.8)$$

Dengan,

D_i = Diameter dalam pipa (inch)

WT = Tebal pipa (mm)

t_{cc} = Tebal anti korosi (mm)

D_{cc} = Diameter anti korosi (inch)

D_{conc} = Diameter concrete coating (inch)

t_{conc} = Tebal concrete coating (mm)

D_{fj} = Diameter field joint coating (inch)

t_{fj} = Tebal lapisan field joint coating (mm)

OD = Diameter luar pipa (inch)

Kemudian setelah didapatkan hasil dari persamaan diatas dimasukkan ke perhitungan berat pipa tiap lapisan pipa. Secara sederhana, perhitungan berat pipa menggunakan konsep kerapatan massa dimana konsep ini tergantung oleh massa suatu benda dengan volume benda tersebut. Begitu pun pada perhitungan berat pipa per satuan panjang yang mana sama dengan perkalian antara kerapatan massa dengan luasan benda tersebut atau sama dengan volume per satuan panjang dari benda tersebut

$$W_{st} = \frac{\pi}{4} \cdot (OD^2 - D_i^2) \rho_{st} \quad (2.9)$$

$$W_{cc} = \frac{\pi}{4} \cdot (D_{cc}^2 - OD^2) \rho_{cc} \quad (2.10)$$

$$V_{conc} = \frac{\pi}{4} \cdot (D_{conc}^2 - D_{cc}^2) \quad (2.11)$$

$$W_{conc} = V_{conc} \cdot \rho_{conc} \quad (2.12)$$

Dimana,

W_{st} = Berat baja pada pipa

ρ_{st} = Massa jenis baja

W_{cc} = Berat anti korosi

ρ_{cc} = Massa jenis anti korosi

V_{conc} = Volume concrete coating

W_{conc} = Berat concrete coating

ρ_{conc} = Massa jenis concrete coating

Bouyancy merupakan salah satu factor yang digunakan untuk mengetahui berat pipa saat terendam. Lalu dalam proses penyambungan 1 pipa dengan pipa lainnya diperlukan adanya field joint coating untuk melindungi serta memberikan bouyancy yang sesuai pada bagian ujung pipa yang sebelumnya masih berupa pipa besi utuh. Persamaan dibawah ini dapat digunakan untuk menghitung berat total pipa yang terendam beserta lapisan yang melindunginya,

$$B = \frac{\pi}{4} \cdot D_{conc}^2 \cdot \rho_w \quad (2.13)$$

$$W_1 = W_{st} \cdot L_j + (W_{cc} + W_{conc}) \cdot (L_j - 2 \cdot L_{cb}) \quad (2.14)$$

$$W_2 = \rho_{fj} \cdot \left[\pi \cdot L_{cb} \cdot \frac{D_{fj}^2 - OD^2}{2} + 2 \cdot \pi \cdot C_b \cdot t_{fj}^2 \cdot \left[\frac{OD}{2} + (t_{fj}) \cdot \frac{2}{3} \right] \right] \quad (2.15)$$

$$W_3 = -2 \cdot \pi \cdot \rho_{conc} \cdot C_b \cdot t_{conc}^2 \cdot \left(\frac{D_{cc}}{2} + \frac{t_{conc}}{2} \right) \quad (2.16)$$

$$W_{air} = \frac{(W_1+W_2+W_3)}{L_j} \quad (2.17)$$

$$W_{sa} = W_{air} + \frac{\xi}{100} \cdot V_{conc} \cdot \rho_w = B \quad (2.18)$$

Dimana,

B = Bouyancy pipa

ρ_w = Massa jenis air

W_1 = Berat pipa tanpa field joint coating

L_j = Panjang pipa

L_{cb} = Panjang Cutback

W_2 = Berat field joint coating

ρ_{fj} = Massa jenis field joint coating

C_b = Panjang concrete bevel

W_3 = Efek dari concrete bevel

2.2.13 Allowable Stress Criteria

Menurut DNV-OS-F101 kriteria tegangan yang diperbolehkan terjadi pada daerah *sagbend* dan *overbend* saat instalasi adalah :

$$\sigma_{eq} < 0.87 f_y \quad (2.19)$$

Dengan,

σ_{eq} = Equivalent Stress, Von Mises

f_y = SMYS

Dengan σ_{eq} adalah tegangan ekuivalen (Von Mises stress) merupakan kombinasi dari *hoop stress*, *longitudinal stress* dan *tangential shear stress*.

Untuk menghitung tegangan ekuivalen (σ_{eq}) diperlukan beberapa besaran dari hoop stress (σ_h) yang mana adalah besaran perbedaan tekanan yang disebabkan adanya pengaruh tekanan dari dalam dan luar pipa yang menekan bagian radial dari pipa. Untuk itu DNV OS F101 menjadikan hoop stress sebagai kriteria yang penting dalam proses mendesain pipa dan merumuskannya sebagai berikut :

$$\sigma_h = (p_i - p_e) \frac{D-t_2}{2t_2} \quad (2.20)$$

Dimana,

σ_h = Hoop Stress

p_i = Tekanan internal

p_e = Tekanan eksternal

D = Pipeline Outside Diameter

$t_2 = t - t_{corr}$

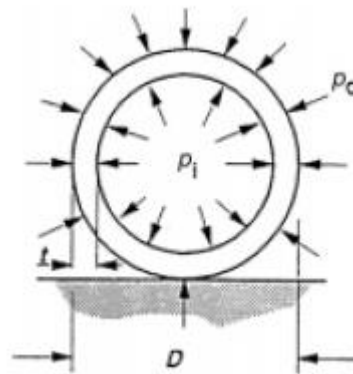

Gambar 2. 8 Hoop Stress pada pipa (Bai, 2014)

Selanjutnya, diperlukan besaran longitudinal stress yang disebabkan poisson ratio dari material dan perubahan suhu yang terjadi (Palmer dan King, 2008). Saat masa operasi, pipeline akan mengalami tekanan internal yang terjadi pada seluruh permukaan pipa (circumferential tensile stress), lalu akibat circumferential stress akan memperbesar ukuran pipa, sehingga diameter pipa akan membesar dan menekan pada arah longitudinal hingga akhirnya pipa akan mengalami penyusutan atau berkurang panjangnya akibat longitudinal stress. Selain itu, pipa akan memuai atau mengalami ekspansi ke segala arah yang digambarkan pada Gambar 2.8. Menurut DNV OS F101 longitudinal stress dapat dirumuskan sebagai berikut :

$$\sigma_1 = \frac{N}{\pi(D-t_2)t_2} + \frac{M}{\frac{\pi(D^4-(D-2t_2)^4)}{32D}} \quad (2.21)$$

Dimana,

σ_1 = Longitudinal stress

N = Gaya aksial yang terjadi pada dinding pipa

M = Bending moment

D = Diameter luar pipa

t₂ = Ketebalan pipa (t-t_{corr})

Longitudinal stress

$$\sigma_l = \sigma_{ec} + \sigma_t + v\sigma_h + \sigma_b$$

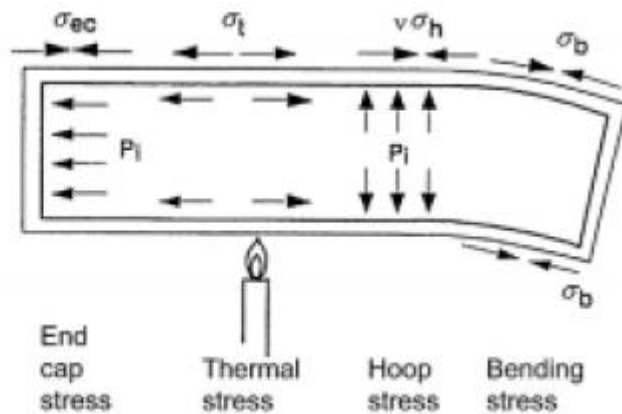

Gambar 2. 9 Faktor yang memengaruhi *Longitudinal Stress* pada pipa (Bai, 2014)

Tangential shear stress adalah tegangan geser akibat adanya tekanan dari luar dan pergerakan fluida di dalam pipa. Berdasarkan teori, tangential shear stress merupakan gaya yang bekerja sejajar bidang dan mengakibatkan defleksi dan bahkan momen puntir pada bidang tersebut. Oleh karena itu, Tegangan ekuivalen (equivalent stress) sangat dibutuhkan untuk mengetahui batas tegangan yang terjadi pada saat overbend dan sagbend. Nilai dari tegangan ekuivalen bisa didapat ketika semua nilai dari komponen penyusunnya telah diketahui kemudian dihitung menggunakan persamaan dibawah. Berdasarkan DNV OS F101 nilai tegangan ekuivalen adalah:

$$\sigma_e \leq \sqrt{\sigma_h^2 + \sigma_l^2 - \sigma_h\sigma_l + 3\tau_{hl}^2} \quad (2.22)$$

Dimana,

σ_h = Hoop Stress

σ_l = Longitudinal Stress

τ_{hl} = Tangential Shear Stress

2.2.13 Metocean

Metocean merupakan data numerik maupun keadaan yang digunakan untuk mengetahui kondisi arus, gelombang, pasang surut, angin, *visibility* dan kelembapan. Data tersebut didapatkan dari survei dengan menggunakan instrumen pengukuran yang digunakan di atau dekat area proyek dikarenakan setiap proyek tengah laut biasanya membutuhkan data lingkungan yang ekstrim untuk mengetahui mendesain bangunan maupun fasilitasnya di tengah laut. Data ini biasanya berguna sebagai masukan untuk *engineering* desain terhadap struktur bangunan apung maupun terpancang yang memasuki daerah eksplorasi.

2.2.14 Analisis Pipelaying

Analisis pipelaying menggunakan program perhitungan dengan basis operasi menggunakan *finite element method* (FEM) seperti yang diilustrasikan pada. Beberapa *software* dikembangkan secara spesifik untuk melakukan pemodelan dan analisis struktural pada permasalahan *non-linear* yang terdapat pada instalasi *pipeline* seperti *PipeLay*, *Orcaflex*, *Offpipe*, *Moses*, dan *Simla*. Software tersebut dapat digunakan untuk analisis sebagai berikut:

1. Analisis *laying* pipa bawah laut statik dan dinamik untuk berbagai konfigurasi *laybarge* dan *stinger* dengan metode S-Lay ataupun J-Lay;
2. Analisis *pipelay initiation*, *abandonment*, dan *recovery*.
3. Perhitungan tegangan pipa statik, panjang bentang, dan defleksi untuk kondisi dasar laut yang tidak rata;
4. Analisis *davit-lift* statik untuk instalasi *riser stalk-on*, *pipeline lifting* dan *above water tie-ins*

2.3 Tegangan Pada Pipa

2.3.1 Tegangan Normal

Tegangan normal merupakan tegangan yang bekerja pada arah tegak lurus terhadap bidang dan dapat berupa tegangan tarik (*tensile stress*) atau tegangan tekan (*compressive stress*).

$$\sigma = \frac{P}{A} \quad (2.23)$$

Dengan :

σ = tegangan normal (N/m²)

P = gaya tarik/tekan (N)

A = luas penampang melintang (m²)

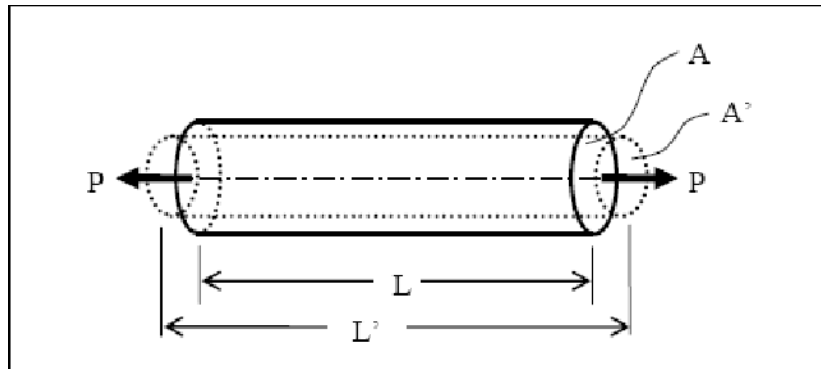

Gambar 2. 10 Pembebanan Aksial Pada Batang Tubular

Pada gambar 2.10 batang tubular dengan luas penampang A dan panjang L mengalami pembebanan *aksial* akibat dari gaya tarik P. Oleh karena itu, batang tersebut akan mengalami perubahan panjang sebesar:

$$\Delta L = L' - L \quad (2.24)$$

Dengan :

ΔL = pertambahan/perubahan panjang (m)

L' = panjang batang setelah menerima beban (m)

L = panjang batang awal (m)

Perbandingan antara pertambahan panjang (ΔL) dengan panjang mula-mula disebut sebagai regangan *aksial* dan dirumuskan sebagai berikut:

$$\varepsilon = \frac{\Delta L}{L} \quad (2.25)$$

Hal ini menunjukkan bahwa jari-jari penampangnya juga mengalami perubahan dari R menjadi R'. Regangan ini disebut dengan regangan radial dan secara matematis dirumuskan sebagai berikut:

$$\varepsilon = \frac{R-R'}{R} \quad (2.26)$$

Dengan :

ε = aksial strain (m)

R = jari-jari penampang awal (m)

R' = jari-jari penampang setelah menerima beban (m)

Perbandingan antara regangan radial dengan regangan aksial disebut sebagai perbandingan *Poisson*. Secara matematis dirumuskan sebagai berikut :

$$\nu = \frac{\varepsilon'}{\varepsilon} \quad (2.27)$$

Dengan :

ε = aksial strain (m)

ε' = radial strain (m)

2.3.2 Tegangan Geser

Tegangan geser (*shear stress*) merupakan tegangan yang bekerja pada arah tangensial terhadap permukaan material.

$$\tau = V/A \quad (2.28)$$

Dengan :

τ = tegangan geser (N/m²)

V = gaya geser (N)

A = luas penampang melintang (m²)

Tegangan geser merupakan tegangan yang bekerja pada suatu elemen bahan yang disertai regangan geser. Tegangan geser tidak mempunyai kecenderungan untuk memperpanjang atau memperpendek material dalam arah x, y, dan z. Ini berarti panjang sisi material tidak berubah, oleh karenanya tegangan geser menyebabkan perubahan bentuk material.

2.3.3 Tegangan Von Mises

Pada elemen tiga dimensi, terdapat tegangan yang bekerja terhadap arah x, y, dan z. Pada tiap-tiap sumbu dapat diketahui tegangan utama ($\sigma_1, \sigma_2, \sigma_3$) yang dihitung dari komponen tegangan dengan persamaan berikut :

$$\begin{bmatrix} \sigma_x - \sigma_0 & \sigma_{xy} & \sigma_{xz} \\ \sigma_{xy} & \sigma_y - \sigma_0 & \sigma_{yz} \\ \sigma_{xz} & \sigma_{yz} & \sigma_z - \sigma_0 \end{bmatrix} = 0 \quad (2.29)$$

Dengan :

σ_0 = tegangan utama yang bekerja pada sumbu

σ_x = tegangan arah sumbu x

σ_y = tegangan arah sumbu y

σ_z = tegangan arah sumbu z

σ_{xy} = tegangan arah sumbu xy

σ_{xz} = tegangan arah sumbu xz

σ_{yz} = tegangan arah sumbu yz

untuk mengetahui total tegangan pada suatu node, diperluakn gabungan tegangan-tegangan utama yang telah disebutkan diatas. Salah satu cara mendapatkan tegangan gabungan adalah dengan menggunakan formula tegangan *Von Misses* yaitu :

$$\sigma_e = \left[[0.5(\sigma_1 - \sigma_2)^2 + (\sigma_2 - \sigma_3)^2(\sigma_3 - \sigma_4)^2] \right]^{0.5} \quad (2.30)$$

Dengan :

σ_e = tegangan *Von Misses*

σ_1 = tegangan utama 1

σ_2 = tegangan utama 2

σ_3 = tegangan utama 3

BAB III METODOLOGI PENELITIAN

3.1 Skema Diagram Alir

3.1.1 Menghitung Tegangan Pipa

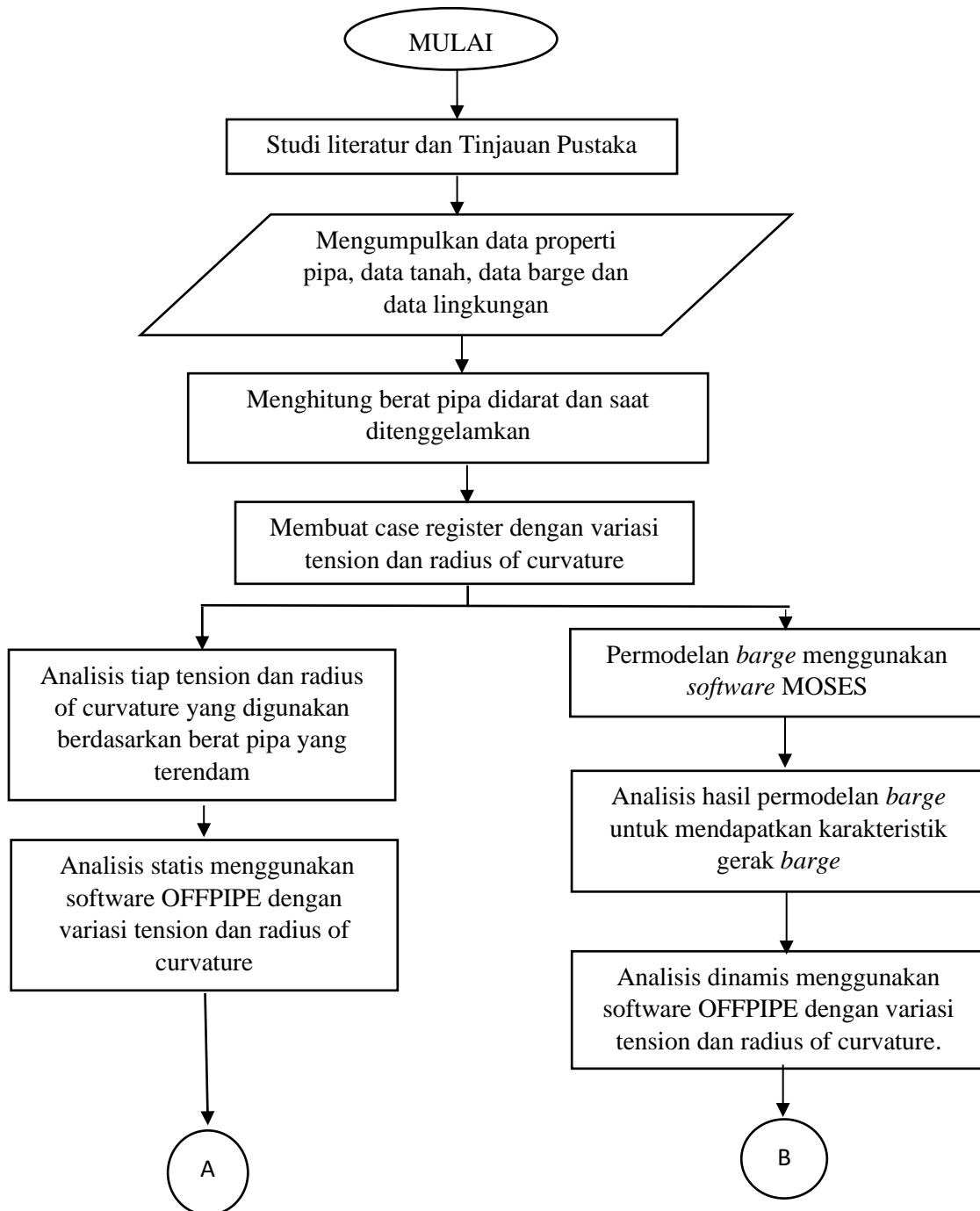

Gambar 3. 1 Diagram alir metodologi penelitian

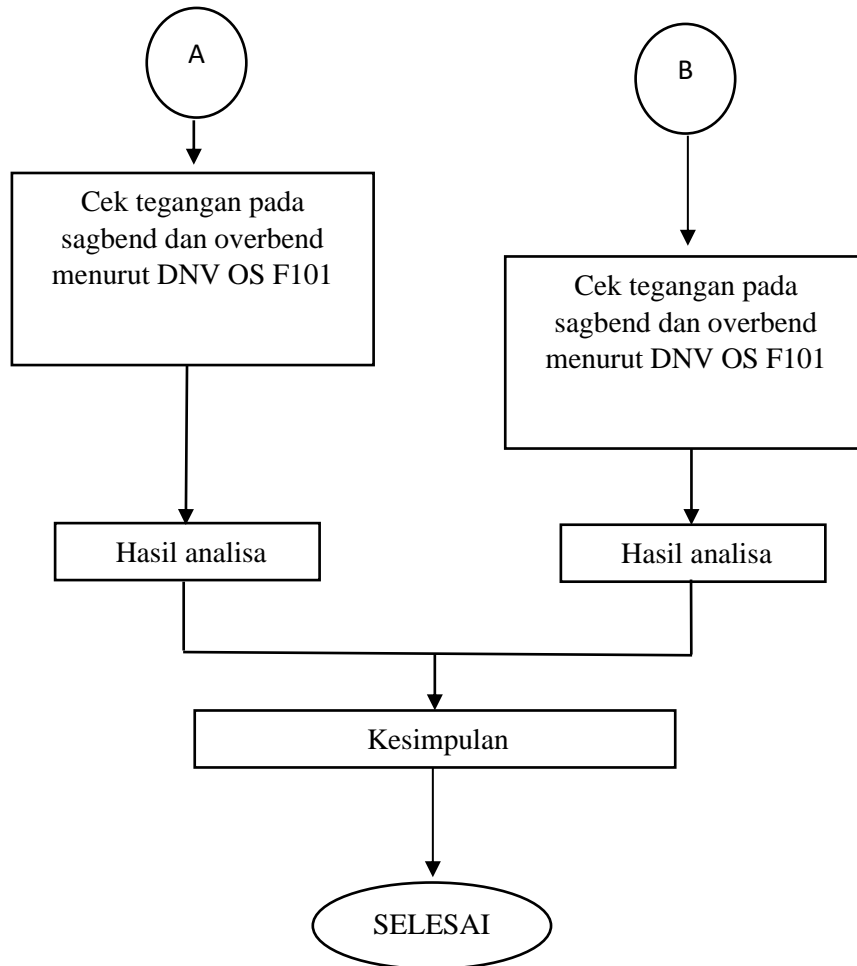

Gambar 3. 1 Diagram alir metodologi penelitian (Lanjutan)

3.2 Penjelasan Diagram Alir

1. Studi Literatur dan Tinjauan Pustaka

Pada tahap pertama, penulis mengumpulkan referensi dari buku, tugas akhir, dan jurnal yang berhubungan dengan analisis tegangan pada instalasi pipeline.

2. Pengumpulan Data

Pengumpulan data yang dibutuhkan untuk menganalisa total tegangan dan stabilitas pipa pada saat instalasi yang akan di-*input* ke dalam *software*. Data tersebut meliputi properti pipa, data *coating* pipa, besar ukuran *pipe laying barge*, panjang *stinger*, dan data lingkungan. Semua data dalam penelitian ini adalah data milik PHE WMO.

3. Penentuan *design case*

Membuat kasus-kasus berupa variasi yang akan dianalisa pada penelitian ini. Variasi yang akan digunakan pada penelitian ini adalah besar tensioner pada tensioner, dan radius of curvature.

4. Input data properti pipa, *tensioner* dan *stinger*

Menginput semua data yang diperlukan seperti data properti pipa, data *coating* pipa, data *tensioner* dan data *stinger* untuk melakukan *run* pada *software* OFFPIPE sehingga mendapatkan hasil berupa *output* total tegangan dan regangan yang terjadi pada saat instalasi pipa berlangsung.

5. Cek tegangan pada area sagbend dan overbend

Setelah running dan hasil sudah ditemukan dilakan pengecekan terhadap output. Output yang dikeluarkan akan berupa tegangan dan regangan di setiap node pipa. Tegangan dan regangan tersebut akan disesuaikan untuk memenuhi.

6. Permodelan barge

Memodelkan barge sesuai *principle dimension* dari data yang sudah didapat. Permodelan barge bertujuan untuk mendapatkan respon gerak barge terhadap gelombang. Untuk pengerjaan permodelan barge akan dibantu oleh software MOSES.

7. Analisis hasil permodelan barge

Setelah dilakukan permodelan barge, akan dilakukan analisis guna mengetahui karakteristik gerak barge dengan beban-beban lingkungan yang sudah ditentukan.

8. Penyusunan kesimpulan

Menyusun kesimpulan yang sesuai dengan permasalahan yang diangkat serta tujuan yang diharapkan.

BAB IV ANALISA DAN PEMBAHASAN

4.1 Pengumpulan dan Identifikasi Data

Data yang digunakan dalam tugas akhir ini menggunakan data dari proyek instalasi pipa bawah laut milik PT. Pertamina Hulu Energi WMO yang berlokasi di sebelah utara selat Madura yang didapatkan penulis pada masa kerja praktik. Pipa tersebut memiliki diameter 6" yang digunakan untuk menyalurkan gas. Pipa ini menghubungkan 2 buah platform yaitu dari platform KE-5 CPP2 (Central Processing Platform) menuju PHE-12 dengan jarak 7.334 km. Gambar lokasi pipa tersebut bias dilihat pada gambar berikut:

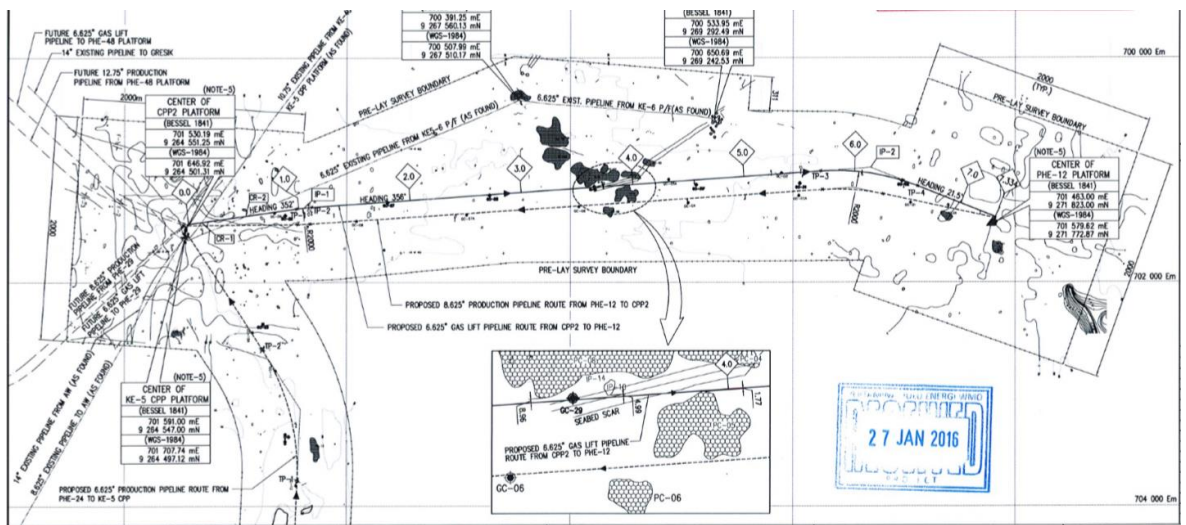

Gambar 4. 1 Peta Jalur Pipa 6" CPP2 ke PHE-12

4.1.1 Data Properti Pipa

Tabel 4. 1 Data Properti Pipa

<i>Description</i>	<i>Unit</i>	<i>Value</i>
Outside Diameter	inch	6,625
Wall Thickness	mm	12,7
Material Grade	mm	API 5L Grade X52
SMYS	MPa	360
SMTS	Mpa	455
Modulus of Elasticity	MPa	207000
Poisson's Ratio	-	0,3
Density of Steel Pipe	Kg/m ³	7850
Pipe Section Length	m	12
Service	-	Three Phase Hydrocarbon
Route	-	6" CPP2 TO PHE-12

Tabel 4. 2 Data Berat Pipa

<i>Description</i>	<i>Unit</i>	<i>Value</i>
Dry (empty)	Kg/m	99,625
Submerged (empty)	Kg/m	58,429
Submerged (hydrotest)	Kg/m	74,847
Submerged (operating)	Kg/m	60,265

Tabel 4. 3 Data *Pressure* Pipa

<i>Description</i>	<i>Unit</i>	<i>Value</i>
Design Pressure	Psig	2360
Operating Pressure	Psig	1690
Hydrotest Pressure	Psig	2950
Design Temperature	°F	320
Operating Temperature	°F	120

4.1.2 Data Lapisan *Corrosion Coating* dan *Concrete Coating***Tabel 4. 4** Data Tebal Lapisan Pipa

<i>Description</i>		<i>Unit</i>	<i>Value</i>
Anti-Corrosion Coating	Material	-	Asphalt Enamel
	Min. Thickness	mm	4
	Density	kg/m ³	1281,5
Concrete Coating	Min. Thickness	mm	25
	Density	kg/m ³	3044

Tabel 4. 5 Data *Sacrificial* Anode Pipa

<i>Description</i>	Parameter	Value
Sacrificial Bracelet Anode	Weight	11.4 kg
	Distance	Every 15 Joints

4.1.3 Data Pipelaying Barge

Tabel 4. 6 Ukuran Dimensi Barge

<i>Description</i>	<i>Value</i>
<i>Name</i>	Kalinda
<i>Classification</i>	BKI Pipe Lay Barge
<i>Flag</i>	Indonesia
<i>LOA</i>	280' (85.344 m)
<i>Breadth</i>	90' (27.432 m)
<i>Depth</i>	18' (5.4864 m)
<i>Draft</i>	1.8 m (in operation)
<i>Mooring</i>	8 Points

Tabel 4. 7 Data Tensioner pada Barge

<i>Description</i>	<i>Value</i>
Electric Tensioner	30 Tons
<i>Back-up Tensioner</i>	2x7 Tons
<i>A&R Winch</i>	30 Tons

4.1.4 Data Stinger

Tabel 4. 8 Data Jenis Stinger yang digunakan

<i>Description</i>	<i>Value</i>
<i>Stinger Type</i>	Fixed Stinger
<i>No. of Stinger Sections</i>	2
<i>No. of Rollers on Stinger</i>	7
Total Stinger Length	± 40 m

4.1.5 Data *Roller* pada *Barge* dan *Stinger*

Tabel 4. 9 Konfigurasi *Roller Support* pada *Barge*

<i>ID Roller</i>	Jarak <i>Roller</i> dari Buritan (m)	Jarak <i>Roller</i> dari <i>Main Deck</i> (m)
Roller 1	77.789175	2.563968333
Roller 2	71.48947	2.477550791
Roller 3	65.37539167	2.36674
Roller 4	59.91100667	2.273926667
Roller 5	53.32126	2.15791
Roller 6	47.32319833	2.053495
Tensioner	38.21566131	1.898618328
Roller 7	29.271005	1.74025
Roller 8	23.13372333	1.635835
Roller 9	17.18206833	1.495019771
Roller 10	10.62712667	1.218175

Tabel 4. 10 Konfigurasi *Roller Support* pada *Stinger*

<i>ID Roller</i>	Jarak <i>Roller</i> dari <i>Hitch</i> (m)	Jarak <i>Roller</i> dari <i>Main Deck</i> (m)
Roller 11	0.944713877	0.359722373
Roller 12	7.966035777	0.386833005
Roller 13	13.96065167	1.155929047
Roller 14	20.49382974	2.132969604
Roller 15	26.34158417	3.138250833
Roller 16	32.16423758	4.208345524
Roller 17	38.05375564	5.508152893

4.1.6 Data Lingkungan

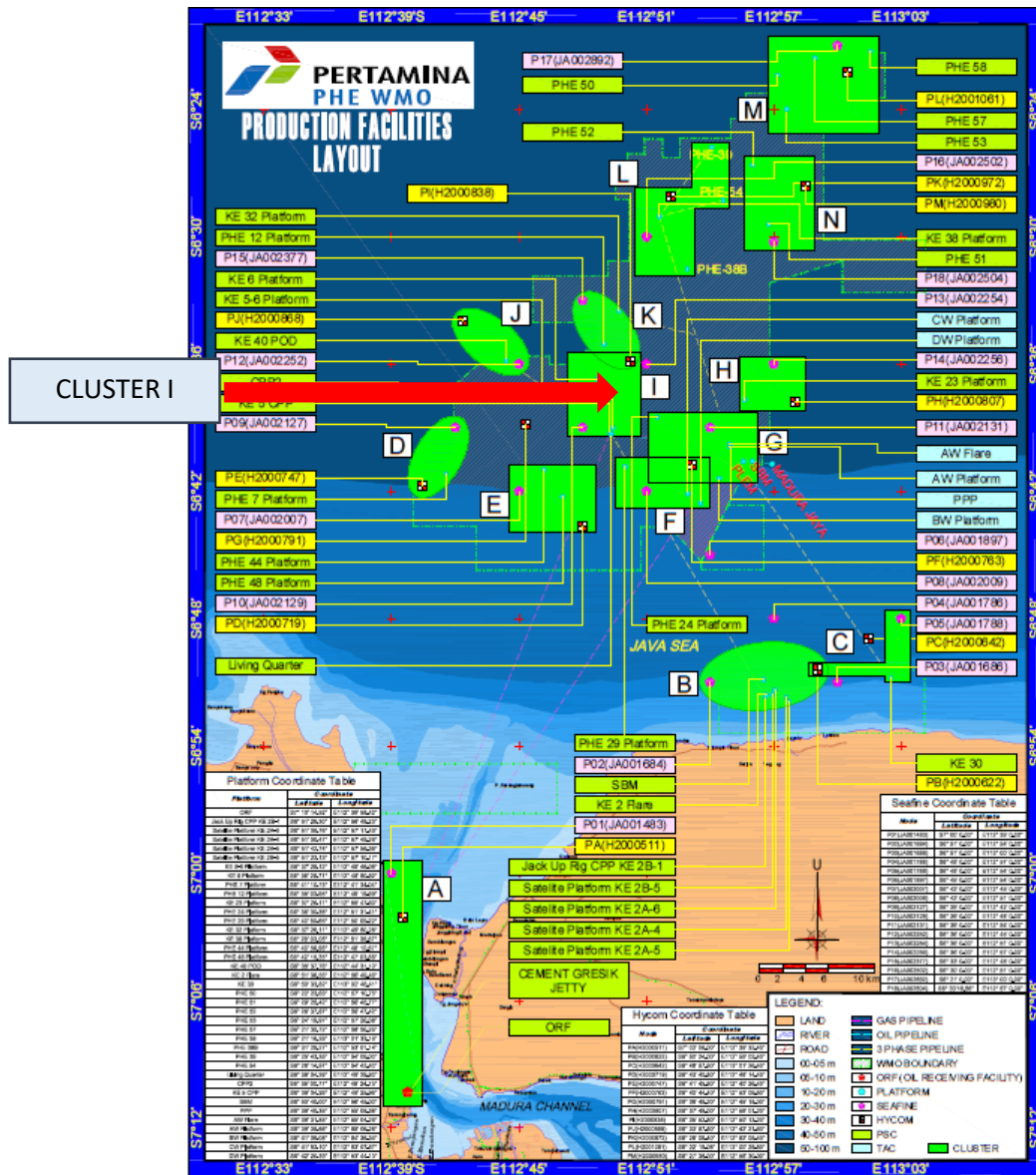

Gambar 4. 2 Peta Wilayah Kerja PT. PHE WMO

Penelitian ini bertempat di Cluster I PT. PHE WMO yang berada di sebelah utara selat Madura. Data lingkungan yang digunakan berasal dari PT. PHE WMO Metocean Data Integration. Di dalam data tersebut juga terdapat kumpulan data dari semua cluster atau wilayah kerja dari PT. PHE WMO. Metocean adalah data numerik dan keadaan yang digunakan untuk mengetahui kondisi arus, gelombang, pasang surut, angin, visibility dan kelembapan. Data tersebut didapatkan dari survei

dengan menggunakan instrumen pengukuran yang digunakan di dekat area proyek dikarenakan setiap proyek tengah laut biasanya membutuhkan data lingkungan yang ekstrim untuk digunakan dalam mendesain bangunan maupun fasilitasnya di tengah laut. Data ini biasanya berguna sebagai masukan untuk engineering desain terhadap struktur bangunan apung maupun terpancang yang memasuki daerah eksplorasi. Adapun Peta wilayah kerja PHE WMO dan data lingkungan yang tersedia sebagai berikut :

Tabel 4. 11 Data Arus 1 Tahunan

Layers and Distance from Water Surface, Water Depth(m) = 53.81	Current Speed (cm/s) and direction (to which)																	
	Depth	Omni	N	NNE	NE	ENE	E	ESE	SE	SSE	S	SSW	SW	WS W	W	WN W	NW	NN W
Layer 10 - Surface (1.0 D)	0	63.59	15.5	15.5	19.3	34.1	63.6	55.35	16.7	7.88	6.55	6.61	9.58	18.2	51.6	58.3	30	19.3
Layer 9 (0.9 D)	-5.38	62.64	15.2	15.3	19	33.6	62.6	54.52	16.5	7.76	6.45	6.51	9.44	18	50.8	57.4	29.5	19.1
Layer 8 (0.8 D)	-10.8	61.59	15	15	18.7	33	61.6	53.61	16.2	7.63	6.34	6.4	9.28	17.7	50	56.5	29	18.7
Layer 7 (0.7 D)	-16.1	60.43	14.7	14.7	18.3	32.4	60.4	52.6	15.9	7.49	6.22	6.28	9.1	17.3	49	55.4	28.5	18.4
Layer 6 (0.6 D)	-21.5	59.11	14.4	14.4	17.9	31.7	59.1	51.45	15.5	7.33	6.09	6.14	8.91	16.9	47.9	54.2	27.9	18
Layer 5 - Mid Depth (0.5 D)	-26.9	57.59	14	14	17.5	30.9	57.6	50.13	15.1	7.14	5.93	5.99	8.68	16.5	46.7	52.8	27.1	17.5
Layer 4 (0.4 D)	-32.3	55.79	13.6	13.6	16.9	29.9	55.8	48.56	14.7	6.91	5.75	5.8	8.4	16	45.2	51.2	26.3	17
Layer 3 (0.3 D)	-37.7	53.54	13	13.1	16.2	28.7	53.5	46.6	14.1	6.63	5.51	5.57	8.07	15.3	43.4	49.1	25.2	16.3
Layer 2 (0.2D)	-43.1	50.53	12.3	12.3	15.3	27.1	50.5	43.98	13.3	6.26	5.2	5.25	7.61	14.5	41	46.3	23.8	15.4
Layer 1 - Near Bed (0.1 D)	-48.4	45.76	11.1	11.2	13.9	24.5	45.8	39.83	12	5.67	4.71	4.76	6.89	13.1	37.1	42	21.6	13.9
(1m ASB)	-52.8	40.22	9.78	9.8	12.2	21.6	40.2	35.01	10.6	4.98	4.14	4.18	6.06	11.5	32.6	36.9	19	12.2

Tabel 4. 12 Data arus 10 Tahunan

Layers and Distance from Water Surface, Water Depth(m) = 53.81	Current Speed (cm/s) and direction (to which)																	
	Depth	Omni	N	NNE	NE	ENE	E	ESE	SE	SSE	S	SSW	SW	WS W	W	WN W	NW	NN W
Layer 10 - Surface (1.0 D)	0	93.79	20.5	21.6	28.7	42.2	93.8	79.87	34.2	22.3	18.5	17.5	19.7	31.4	63.6	68.1	40.3	26.3
Layer 9 (0.9 D)	-5.38	92.39	20.2	21.3	28.3	41.6	92.4	78.68	33.7	21.9	18.2	17.3	19.5	30.9	62.7	67.1	39.7	25.9
Layer 8 (0.8 D)	-10.8	90.85	19.9	20.9	27.8	40.9	90.9	77.36	33.1	21.6	17.9	17	19.1	30.4	61.6	65.9	39	25.5
Layer 7 (0.7 D)	-16.1	89.13	19.5	20.5	27.3	40.1	89.1	75.9	32.5	21.2	17.6	16.7	18.8	29.8	60.5	64.7	38.3	25
Layer 6 (0.6 D)	-21.5	87.19	19.1	20.1	26.7	39.3	87.2	74.25	31.8	20.7	17.2	16.3	18.4	29.2	59.2	63.3	37.4	24.5
Layer 5 - Mid Depth (0.5 D)	-26.9	84.95	18.6	19.6	26	38.2	85	72.34	31	20.2	16.8	15.9	17.9	28.4	57.6	61.7	36.5	23.8
Layer 4 (0.4 D)	-32.3	82.28	18	19	25.2	37	82.3	70.07	30	19.5	16.2	15.4	17.3	27.5	55.8	59.7	35.3	23.1
Layer 3 (0.3 D)	-37.7	78.97	17.3	18.2	24.2	35.6	79	67.25	28.8	18.8	15.6	14.8	16.6	26.4	53.6	57.3	33.9	22.1
Layer 2 (0.2D)	-43.1	74.53	16.3	17.2	22.8	33.6	74.5	63.46	27.2	17.7	14.7	13.9	15.7	24.9	50.6	54.1	32	20.9
Layer 1 - Near Bed (0.1 D)	-48.4	67.5	14.8	15.6	20.7	30.4	67.5	57.48	24.6	16	13.3	12.6	14.2	22.6	45.8	49	29	18.9
(1m ASB)	-52.8	59.32	13	13.7	18.2	26.7	59.3	50.52	21.6	14.1	11.7	11.1	12.5	19.8	40.2	43.1	25.5	16.6

Tabel 4. 13 Data Parameter Air Laut

Description	Satuan	Nilai
Sea water density	kg/m ³	1025

Tabel 4. 14 Data Tanah

<i>Description</i>	<i>Unit</i>	<i>Value</i>
Jenis Tanah	-	<i>Very Soft Greenish Grey Clay</i>
<i>Undrained Shear Strength, Su</i>	kPa	9 - 10

Tabel 4. 15 Kedalaman Pipa

<i>Description</i>	<i>Unit</i>	Min. Depth	Max. Depth	Av. Depth
6" CPP2 TO PHE-12	m	55.142127	55.9788	55.4894

4.2 Analisis statis S-Lay pada pipa saat instalasi

4.2.1 Design Case Analisis Statis

Dalam melakukan analisis total tegangan terbesar yang terjadi pada saat instalasi, design case harus dibuat. Design case adalah tabel untuk menjelaskan variasi yang akan dilakukan pada tiap variable. Data yang digunakan adalah data pipa dengan outside diameter 6.625 inch sesuai data properti pipa yang telah didapatkan. Dalam penelitian ini penulis melakukan variasi 2 variabel yaitu *stinger radius of curvature* dan kekuatan tensioner. Sehingga didapatkan 9 case untuk analisis statis. Penulis menggunakan beberapa perintah pada OFFPIPE dalam melakukan analisis statis yaitu seperti yang dijelaskan dalam tabel 4.17

Tabel 4. 16 *Design Case Analisis Statis*

Case	Depth	Outside Diameter	Wall Thickness	Stinger Radius of Curvature	Tensioner
	m	Inch	mm	m	ton
1	55,4668	6,625	12,7	200	30
2				300	
3				400	
4				200	35
5				300	
6				400	
7				200	40
8				300	
9				400	

Tabel 4. 17 Perintah yang Digunakan untuk Analisis Statis

Input/Output/Heading data	Pipe and A&R Cable Data	Pipelay Vessel Data	Stinger Data	Sagbend and Seabed Data
HEAD	PIPE	TENS	STIN	GEOM
PRIN	COAT	BARG	SUPP	CURR
PROF	CABLE	SUPP	BALL	SOIL
HIST	BUND	DAVI	BUOY	LENG
PLTR	FLUI	DCAB	WEIG	FLOA
DIAG	MOME		SECT	SPAN

4.2.2 Hasil Analisis Statis S-Lay

Analisis statis dilakukan untuk mengetahui total tegangan yang terjadi pada pipa saat instalasi S-lay dilakukan. Jika hasil analisis dengan variasi tertentu ada yang tidak sesuai atau melampaui batas yang diijinkan oleh DNV OS F-101, maka variasi tersebut tidak bisa dilanjutkan untuk analisis dinamis. Analisis statis ini dilakukan dengan menggunakan software OFFPIPE dan menggunakan data properti pipa, barge, stinger, lingkungan, dan roller yang sudah didapat dengan

asumsi barge dalam keadaan diam.

Setelah dilakukan analisis statis seperti yang sudah dijelaskan menggunakan software OFFPIPE, maka akan didapatkan hasil analisis pipa saat kondisi statis berupa total tegangan dan %SMYS.. Adapun hasil analisa statis pada tension 30, 35, dan 40 ton yang sudah dilakukan oleh penulis :

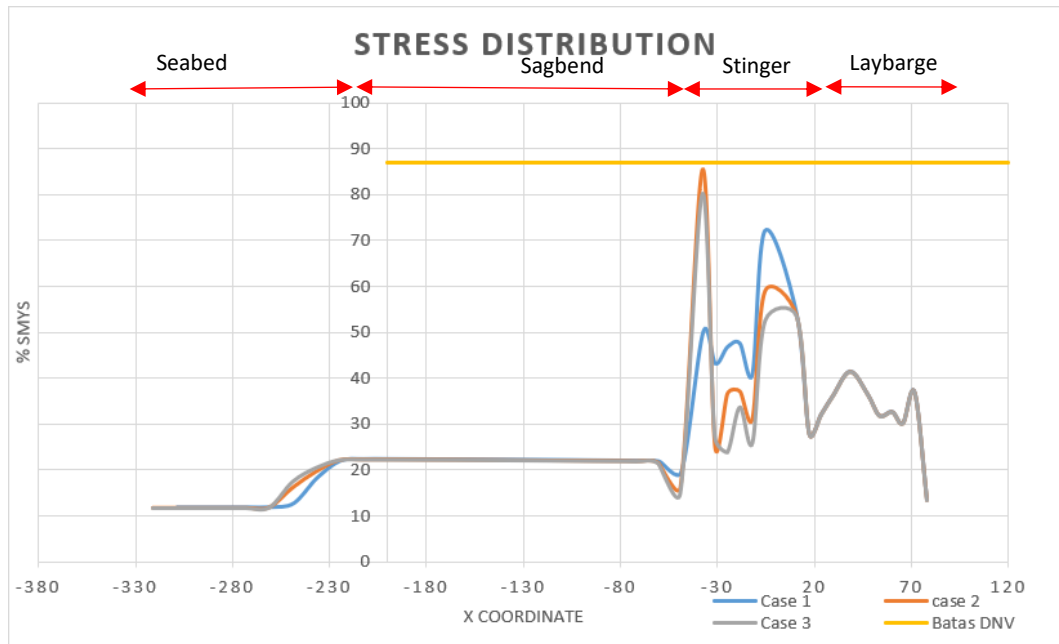

Gambar 4. 3 Grafik Total Tegangan pada Tension 30 ton.

Tabel 4. 18 Hasil Total Tegangan daerah Overbend Pada Tension 30 ton

Case	pipe node	section	coordinate		total stress (mpa)	%SMYS
			x	y		
1	24	STINGER	-5,62	-2,46	259,33	72,04
2	34	STINGER	-37,74	-11,26	319,68	85,47
3	24	STINGER	-37,91	-10,65	180,39	52,49

Dilihat dari grafik distribusi total tegangan dan tabel hasil analisis statis pada *case 1* sampai *case 3* didapatkan besar tegangan maksimum yang terjadi pada variasi tension 30 ton yang terletak pada *case 2* dengan daerah kritis *overbend* adalah sebesar 319,68 Mpa atau sebesar 85% dari SMYS, terjadi di bagian ujung *stinger* pada *node* pipa ke-34 dengan koordinat $x = -37,74$ dan koordinat $y = -11,26$ dimana bisa dilihat pada tabel 4. 10 bahwa roller support terakhir berjarak 38 meter dari hitch sedangkan Panjang total stinger adalah 40 meter sehingga pada titik ini

tidak ada roller support yang menyangga .

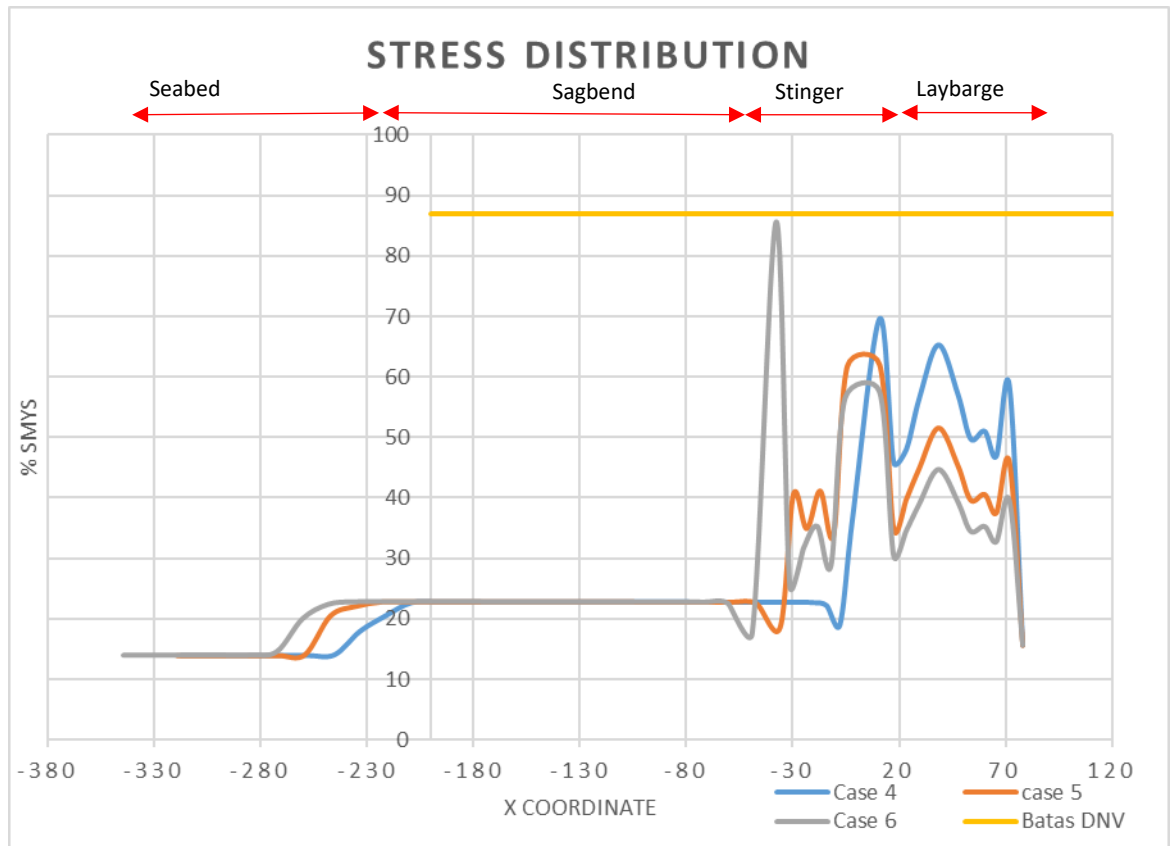

Gambar 4. 4 Grafik Total Tegangan pada Tension 35 ton.

Tabel 4. 19 Hasil Total Tegangan daerah Overbend Pada Tension 35 ton

Case	pipe node	Section	coordinate		total stress (mpa)	%SMYS
			x	y		
4	21	LAYBARGE	10,63	-5,12	250,74	69,65
5	21	LAYBARGE	10,63	-1,22	222,82	61,89
6	34	STINGER	-37,91	-10,65	321,29	85,69

Dilihat dari grafik distribusi total tegangan yang terjadi dan tabel hasil analisis statis diatas pada *case 4* sampai *case 6* didapatkan besar tegangan maksimum yang terjadi pada variasi tension 35 ton yang terletak pada *case 6* dengan daerah kritis *overbend* adalah sebesar 321,29 Mpa atau sebesar 85% dari SMYS, terjadi di *roller support* bagian *stinger* pada *node* pipa ke-34 dengan koordinat $x = -37,91$ dan koordinat $y = -11,26$ dimana bisa dilihat pada tabel 4. 10 bahwa roller support terakhir berjarak 38 meter dari hitch sedangkan Panjang total

stinger adalah 40 meter sehingga pada titik ini tidak ada roller support yang menyangga.

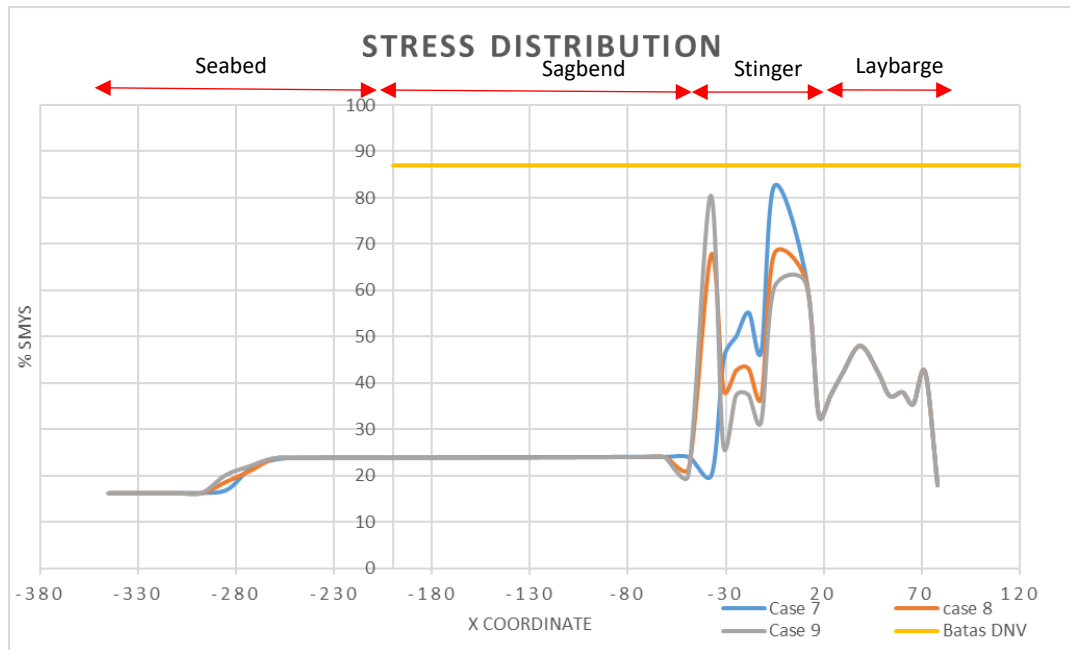

Gambar 4. 5 Grafik Total Tegangan pada Tension 40 ton.

Tabel 4. 20 Hasil Total Tegangan daerah Overbend pada Tension 40 ton.

Case	pipe node	section	coordinate		total stress (mpa)	%SMYS
			x	y		
7	24	STINGER	-5,62	-2,46	297,06	82,52
8	24	STINGER	-5,62	-2,46	244,19	67,83
9	34	STINGER	-37,91	-10,65	290,63	80,51

Dilihat dari grafik distribusi total tegangan dan tabel hasil analisis statis pada case 7 sampai case 9 diatas didapatkan besar tegangan maksimum yang terjadi pada variasi tension 40 ton yang terletak pada case 7 dengan daerah kritis *overbend* adalah sebesar 297,06 Mpa atau sebesar 82,52% dari SMYS, terjadi pada *node* pipa ke-24 dengan koordinat $x = -5,62$ dan koordinat $y = -2,46$. Bahkan dalam case 7 yang merupakan case yang mengalami total stress terbesar dalam variasi tension 40 Mpa dan stinger radius of curvature 200 meter. Namun, total stress dan %SMYS tidak melebihi total stress dan %SMYS yang diijinkan pada DNV OS F101 yaitu 87%SMYS.

Tabel 4. 21 Hasil Analisis Statis Instalasi S-Lay

Case	Depth	Outside Diameter	Wall Thickness	Stinger Radius of Curvature	Tensioner	total tegangan				Verify
	m	Inch	mm	m	ton	overbend		sagbend		
						mpa	%SMYS	mpa	%SMYS	
1	55,4668	6,625	12,7	200	30	259,33	72,04	80,21	22	OK
2				300		319,23	85,47	80,22	22	OK
3				400		180,39	80,11	80,22	22	OK
4				35	200	250,74	69,65	82,21	22	OK
5					300	222,82	61,89	82,22	22	OK
6					400	321,29	85,69	82,22	22	OK
7				40	200	297,06	82,52	86,51	24	OK
8					300	244,19	67,83	86,51	24	OK
9					400	290,63	80,51	86,51	24	OK

Berdasarkan tabel diatas, dapat dilihat bahwa hasil analisa statis S-Lay yang sudah dilakukan oleh penulis dengan variasi yang sudah ditentukan sesuai dengan *design case* menunjukkan total tegangan yang paling besar terjadi adalah pada *case* 6 dengan besar total tegangan sebesar 120,29 MPa atau sebesar 85,69 % dari SMYS. Pada case ini total stress masih dibawah nilai total stress yang diijinkan oleh DNV OS F101 yaitu harus dibawah 87% SMYS. Pada *Case 7* telah dilakukan variasi variabel radius kurvatur *stinger* sebesar 200 meter dan variabel *tension* sebesar 40 Ton dan didapatkan nilai total stress sebesar 297,06 MPa atau sebesar 82,52 % SMYS. Untuk total tegangan terbesar terjadi pada variasi tensioner sebesar 35 Ton pada *case* 6 sebesar 120,29 MPa atau sebesar 85,69 % dari SMYS. *Case 6* tersebut telah dilakukan dengan variasi variabel radius kurvatur *stinger* sebesar 400 meter dan variabel *tension* sebesar 35 Ton. Untuk total tegangan terbesar terjadi pada variasi tensioner sebesar 30 Ton pada *case* 2 sebesar 319,68 MPa atau sebesar 85,47 % dari SMYS. *Case 2* tersebut telah dilakukan dengan variasi variabel radius kurvatur *stinger* sebesar 300 meter dan variabel *tension* sebesar 30 Ton.

Berdasarkan hasil tegangan terbesar yang sudah dijelaskan semua terjadi pada daerah kritis *overbend* dan mayoritas terjadi pada bagian *stinger* yaitu pada bagian ujung *stinger* dimana saat proses instalasi pipa posisi tersebut sudah meninggalkan *stinger* sehingga pipa tidak tertumpu dengan sempurna (tidak ada *roller support*). Sedangkan pada daerah kritis *sagbend* total tegangan yang terjadi sangat kecil yaitu sebesar 22% hingga 24% dari SMYS. Total tegangan yang terjadi pada analisa statis di daerah kritis *overbend* maupun *sagbend* yang terjadi, semuanya sudah memenuhi aturan DNV OS-F101 dimana % SMYS yang terjadi harus kurang dari 87%. Untuk *output* hasil analisis statis yang lebih lengkap bisa dilihat pada bagian lampiran

Tabel 4. 22 Ringkasan hasil regangan statis

Case	Total Strain	Allowable Strain Criteria	Verify
	Overbend	%	
	%		
1	0.1033	0.205	OK
2	0.095		OK
3	0.1153		OK
4	0.113		OK
5	0.092		OK
6	0.1373		OK
7	0.1042		OK
8	0.096		OK
9	0.092		OK
Max =	0.1373		OK

Regangan yang terjadi pada saat instalasi yang paling besar dari semua *case* yang sudah dianalisis adalah pada *case* 9 yaitu sebesar 0.153% jika dibandingkan dengan *Allowable Strain Criteria* yang tercantum pada DNV OS-F101 hasil tersebut masih memenuhi karena hasil tersebut termasuk kurang dari 0.205%.

4.3 validasi hasil tegangan

Hasil dari Analisa statis diatas akan divalidasi menggunakan perhitungan manual untuk Analisa statis, perhitungan manual menggunakan Panjang stinger 40 m untuk setiap variasi tension dan radius of curvaturesnya.

4.3.1 Tegangan Pada Tension 30 Ton dan Radius of Curvature 200 m

Untuk tension sebesar 30 ton, Panjang stinger 40 m, dan kedalaman node pipa -12,47 m, hasil tegangannya sebagai berikut :

Perhitungan Manual

$$\sigma_t = \frac{294}{0,0217} + \frac{1}{4} 3,14 0,168275^2 10250 \frac{-12,47}{0,0217} = 13,39856 \text{ MPa}$$

$$\sigma_{\text{ver}} = \frac{1}{2} 22,1 \frac{0,168275}{31} = 144,08 \text{ MPa}$$

$$\sigma_{\text{hor}} = \frac{1}{2} -0,725 \frac{0,168275}{31} = -4,73 \text{ MPa}$$

$$\sigma_c = \sqrt{144,08^2 + \sigma - 4,73^2} = 144,16 \text{ MPa}$$

$$\sigma_h = \frac{1}{2} 10250 \cdot 0,168275 \frac{-12,47}{0,0127} = -0,84679 \text{ MPa}$$

$$\sigma_{\text{vm}} = [(144,16 + 13,39856)^2 + -0,84679^2 - (144,16 + 13,39856) - 0,84679]^{0,5} = 126,9389539$$

Hasil OFFPIPE

$$\sigma_t = 13,74 \text{ MPa}$$

$$\sigma_{\text{ver}} = 144,16 \text{ MPa}$$

$$\sigma_{\text{hor}} = -4,71 \text{ MPa}$$

$$\sigma_c = 144,24 \text{ MPa}$$

$$\sigma_h = -0,83 \text{ MPa}$$

$$\sigma_{\text{vm}} = 126,74 \text{ MPa}$$

4.3.2 Tegangan Pada Tension 30 Ton dan Radius of Curvature 300 m

Untuk tension sebesar 30 ton, Panjang stinger 40 m, dan kedalaman node pipa -11,26 m, hasil tegangannya sebagai berikut :

Perhitungan Manual

$$\sigma_t = \frac{294}{0,0217} + \frac{1}{4} 3,14 0,168275^2 10250 \frac{-11,26}{0,0217} = 13,41125 \text{ MPa}$$

$$\sigma_{\text{ver}} = \frac{1}{2} 19,99 \frac{0,168275}{31} = 130,39 \text{ MPa}$$

$$\sigma_{\text{hor}} = \frac{1}{2} -0,636 \frac{0,168275}{31} = -4,15 \text{ MPa}$$

$$\sigma_c = \sqrt{130,39^2 + \sigma - 4,15^2} = 130,46 \text{ MPa}$$

$$\sigma_h = \frac{1}{2} 10250 \cdot 0,168275 \frac{-11,26}{0,0127} = -0,76462 \text{ MPa}$$

$$\sigma_{\text{vm}} = [(130,46 + 13,41125)^2 + -0,76462^2 - (130,46 + 13,41125) - 0,76462]^{0,5} = 143,3697505 \text{ MPa}$$

Hasil OFFPIPE

$$\sigma_t = 13,8 \text{ MPa}$$

$$\sigma_{\text{ver}} = 130,47 \text{ MPa}$$

$$\sigma_{\text{hor}} = -4,18 \text{ MPa}$$

$$\sigma_c = 130,23 \text{ MPa}$$

$$\sigma_h = -0,75 \text{ MPa}$$

$$\sigma_{\text{vm}} = 143,47 \text{ MPa}$$

4.3.3 Tegangan Pada Tension 30 Ton dan Radius of Curvature 400 m

Untuk tension sebesar 30 ton, Panjang stinger 40 m, dan kedalaman node pipa -10,65 m, hasil tegangannya sebagai berikut :

Perhitungan Manual

$$\sigma_t = \frac{294}{0,0217} + \frac{1}{4} 3,14 0,168275^2 10250 \frac{-10,65}{0,0217} = 13,41765 \text{ MPa}$$

$$\sigma_{\text{ver}} = \frac{1}{2} 19,10 \frac{0,168275}{31} = 124,62 \text{ MPa}$$

$$\sigma_{\text{hor}} = \frac{1}{2} -0,640 \frac{0,168275}{31} = -4,17 \text{ MPa}$$

$$\sigma_c = \sqrt{124,62^2 + \sigma - 4,17^2} = 124,90 \text{ MPa}$$

$$\sigma_h = \frac{1}{2} 10250 \cdot 0,168275 \frac{-10,65}{0,0127} = -0,7232 \text{ MPa}$$

$$\sigma_{\text{vm}} = [(124,90 + 13,41765)^2 + -0,7232^2 - (124,90 + 13,41765) - 0,7232]^{0,5} \\ = 137,8160167$$

Hasil OFFPIPE

$$\sigma_t = 13,82 \text{ MPa}$$

$$\sigma_{\text{ver}} = 124,75 \text{ MPa}$$

$$\sigma_{\text{hor}} = -4,19 \text{ MPa}$$

$$\sigma_c = 130,39 \text{ MPa}$$

$$\sigma_h = -0,71 \text{ MPa}$$

$$\sigma_{\text{vm}} = 137,47 \text{ MPa}$$

4.3.4 Tegangan Pada Tension 35 Ton dan Radius of Curvature 200 m

Untuk tension sebesar 35 ton, Panjang stinger 40 m, dan kedalaman node pipa -21,69 m, hasil tegangannya sebagai berikut :

$$\sigma_t = \frac{294}{0,0217} + \frac{1}{4} 3,14 0,168275^2 10250 \frac{-21,69}{0,0217} = 13,30189 \text{ MPa}$$

$$\sigma_{\text{ver}} = \frac{1}{2} 19,53 \frac{0,168275}{31} = 123,92 \text{ MPa}$$

$$\sigma_{\text{hor}} = \frac{1}{2} -1,010 \frac{0,168275}{31} = -6,59 \text{ MPa}$$

$$\sigma_c = \sqrt{123,92^2 + \sigma - 6,59^2} = 124,10 \text{ MPa}$$

$$\sigma_h = \frac{1}{2} 10250 \cdot 0,168275 \frac{-21,69}{0,0127} = -1,47289 \text{ MPa}$$

$$\sigma_{\text{vm}} = [(124,10 + 13,3018)^2 + -1,47289^2 - (124,10 + 13,3018) - 1,47289]^{0,5} = 136,9035208$$

Hasil OFFPIPE

$$\sigma_t = 13,63 \text{ MPa}$$

$$\sigma_{\text{ver}} = 123,33 \text{ MPa}$$

$$\sigma_{\text{hor}} = -6,58 \text{ MPa}$$

$$\sigma_c = 124,05 \text{ MPa}$$

$$\sigma_h = -1,44 \text{ MPa}$$

$$\sigma_{\text{vm}} = 136,79 \text{ MPa}$$

4.3.5 Tegangan Pada Tension 35 Ton dan Radius of Curvature 200 m

Untuk tension sebesar 35 ton, Panjang stinger 40 m, dan kedalaman node pipa -15,84 m, hasil tegangannya sebagai berikut :

Perhitungan Manual

$$\sigma_t = \frac{294}{0,0217} + \frac{1}{4} 3,14 0,168275^2 10250 \frac{-15,84}{0,0217} = 13,36323 \text{ MPa}$$

$$\sigma_{\text{ver}} = \frac{1}{2} 20,924 \frac{0,168275}{31} = 136,47 \text{ MPa}$$

$$\sigma_{\text{hor}} = \frac{1}{2} - 1,270 \frac{0,168275}{31} = -8,28 \text{ MPa}$$

$$\sigma_{\text{c}} = \sqrt{136,47^2 + \sigma - 8,28^2} = 136,72 \text{ MPa}$$

$$\sigma_{\text{h}} = \frac{1}{2} 10250 \cdot 0,168275 \frac{-15,84}{0,0127} = -1,07564 \text{ MPa}$$

$$\sigma_{\text{vm}} = [(136,72 + 13,36323)^2 + -1,07564^2 - (136,72 + 13,36323) - 1,07564]^{0,5} = 149,5826663 \text{ MPa}$$

Hasil OFFPIPE

$$\sigma_{\text{t}} = 13,38 \text{ MPa}$$

$$\sigma_{\text{ver}} = 136,54 \text{ MPa}$$

$$\sigma_{\text{hor}} = -8,65 \text{ MPa}$$

$$\sigma_{\text{c}} = 136,97 \text{ MPa}$$

$$\sigma_{\text{h}} = -1,05 \text{ MPa}$$

$$\sigma_{\text{vm}} = 149,69 \text{ MPa}$$

4.3.6 Tegangan Pada Tension 35 Ton dan Radius of Curvature 400 m

Untuk tension sebesar 35 ton, Panjang stinger 40 m, dan kedalaman node pipa -10,65 m, hasil tegangannya sebagai berikut :

Perhitungan Manual

$$\sigma_{\text{t}} = \frac{294}{0,0217} + \frac{1}{4} 3,14 0,168275^2 10250 \frac{-10,65}{0,0217} = 13,41765 \text{ MPa}$$

$$\sigma_{\text{ver}} = \frac{1}{2} 18,418 \frac{0,168275}{31} = 120,13 \text{ MPa}$$

$$\sigma_{\text{hor}} = \frac{1}{2} - 0,607 \frac{0,168275}{31} = -3,96 \text{ MPa}$$

$$\sigma_{\text{c}} = \sqrt{120,13^2 + \sigma - 3,96^2} = 120,19 \text{ MPa}$$

$$\sigma_{\text{h}} = \frac{1}{2} 10250 \cdot 0,168275 \frac{-10,65}{0,0127} = -0,7232 \text{ MPa}$$

$$\sigma_{vm} = [(120,19 + 13,41765)^2 + -0,7232^2 - (120,19 + 13,41765) \cdot -0,7232]^{0,5} = 133,1059589 \text{ MPa}$$

Hasil OFFPIPE

$$\sigma_t = 13,93 \text{ MPa}$$

$$\sigma_{ver} = 120,43 \text{ MPa}$$

$$\sigma_{hor} = -3,6 \text{ MPa}$$

$$\sigma_c = 120,29 \text{ MPa}$$

$$\sigma_h = -0,71 \text{ MPa}$$

$$\sigma_{vm} = 133,69 \text{ MPa}$$

4.3.7 Tegangan Pada Tension 40 Ton dan Radius of Curvature 200 m

Untuk tension sebesar 40 ton, Panjang stinger 40 m, dan kedalaman node pipa -12,34 m, hasil tegangannya sebagai berikut :

Perhitungan Manual

$$\sigma_t = \frac{294}{0,0217} + \frac{1}{4} 3,14 0,168275^2 10250 \frac{-12,34}{0,0217} = 13,39993 \text{ MPa}$$

$$\sigma_{ver} = \frac{1}{2} 20,232 \frac{0,168275}{31} = 132,61 \text{ MPa}$$

$$\sigma_{hor} = \frac{1}{2} -1,287 \frac{0,168275}{31} = -8,39 \text{ MPa}$$

$$\sigma_c = \sqrt{132,61^2 + \sigma - 8,39^2} = 132,88 \text{ MPa}$$

$$\sigma_h = \frac{1}{2} 10250 \cdot 0,168275 \frac{-12,34}{0,0127} = -0,83796 \text{ MPa}$$

$$\sigma_{vm} = [(132,88 + 13,3999)^2 + -0,83796^2 - (132,88 + 13,3999) \cdot -0,83796]^{0,5} = 145,7786068 \text{ MPa}$$

Hasil OFFPIPE

$$\sigma_t = 13,88 \text{ MPa}$$

$$\sigma_{ver} = 132,94 \text{ MPa}$$

$$\sigma_{hor} = -8,29 \text{ MPa}$$

$$\sigma_c = 132,76 \text{ MPa}$$

$$\sigma_h = -0,82 \text{ MPa}$$

$$\sigma_{vm} = 145,21 \text{ MPa}$$

4.3.8 Tegangan Pada Tension 40 Ton dan Radius of Curvature 300 m

Untuk tension sebesar 40 ton, Panjang stinger 40 m, dan kedalaman node pipa -11,26 m, hasil tegangannya sebagai berikut :

Perhitungan Manual

$$\sigma_t = \frac{294}{0,0217} + \frac{1}{4} 3,14 0,168275^2 10250 \frac{-11,26}{0,0217} = 13,41125 \text{ MPa}$$

$$\sigma_{ver} = \frac{1}{2} 18,929 \frac{0,168275}{31} = 123,46 \text{ MPa}$$

$$\sigma_{hor} = \frac{1}{2} -0,475 \frac{0,168275}{31} = -3,10 \text{ MPa}$$

$$\sigma_c = \sqrt{123,46^2 + \sigma - 3,10^2} = 123,50 \text{ MPa}$$

$$\sigma_h = \frac{1}{2} 10250 \cdot 0,168275 \frac{-11,26}{0,0127} = -0,76462 \text{ MPa}$$

$$\sigma_{vm} = [(123,50 + 13,41125)^2 + -0,76462^2 - (123,50 + 13,41125) - 0,76462]^{0,5} = 136,409674$$

Hasil OFFPIPE

$$\sigma_t = 13,99 \text{ MPa}$$

$$\sigma_{ver} = 123,57 \text{ MPa}$$

$$\sigma_{hor} = -3,51 \text{ MPa}$$

$$\sigma_c = 123,67 \text{ MPa}$$

$$\sigma_h = -0,75 \text{ MPa}$$

$$\sigma_{vm} = 136,67 \text{ MPa}$$

4.3.9 Tegangan Pada Tension 40 Ton dan Radius of Curvature 400 m

Untuk tension sebesar 40 ton, Panjang stinger 40 m, dan kedalaman node pipa -10,65 m, hasil tegangannya sebagai berikut :

Perhitungan Manual

$$\sigma_t = \frac{294}{0,0217} + \frac{1}{4} 3,14 0,168275^2 10250 \frac{-10,65}{0,0217} = 13,41765 \text{ Mpa}$$

$$\sigma_{\text{ver}} = \frac{1}{2} 17,873 \frac{0,168275}{31} = 116,57 \text{ MPa}$$

$$\sigma_{\text{hor}} = \frac{1}{2} -0,559 \frac{0,168275}{31} = -3,65 \text{ MPa}$$

$$\sigma_c = \sqrt{116,57^2 + \sigma - 3,65^2} = 116,63 \text{ MPa}$$

$$\sigma_h = \frac{1}{2} 10250 \cdot 0,168275 \frac{-10,65}{0,0127} = -0,7232 \text{ MPa}$$

$$\sigma_{\text{vm}} = [(116,63 + 13,41765)^2 + -0,7232^2 - (116,63 + 13,41765) \cdot -0,7232]^{0,5} = 129,5459125 \text{ MPa}$$

Hasil OFFPIPE

$$\sigma_t = 13,02 \text{ MPa}$$

$$\sigma_{\text{ver}} = 116,63 \text{ MPa}$$

$$\sigma_{\text{hor}} = -3,69 \text{ MPa}$$

$$\sigma_c = 116,63 \text{ MPa}$$

$$\sigma_h = -0,71 \text{ MPa}$$

$$\sigma_{\text{vm}} = 129,51 \text{ MPa}$$

4.4 Permodelan Pipe Laying Barge

Untuk melakukan analisis saat kondisi dinamis, perlu dilakukan permodelan terhadap *pipe laying barge* yang akan digunakan untuk instalasi. permodelan ini bertujuan untuk menganalisa respon gerakan *laybarge*, karena pergerakan *laybarge* dapat mempengaruhi besar total tegangan yang terjadi pada saat instalasi. Untuk *laybarge*, penulis menggunakan *pipe laying barge* Kalinda sesuai data. Software yang digunakan untuk permodelan ini adalah MOSES. Berikut hasil permodelan yang dilakukan :

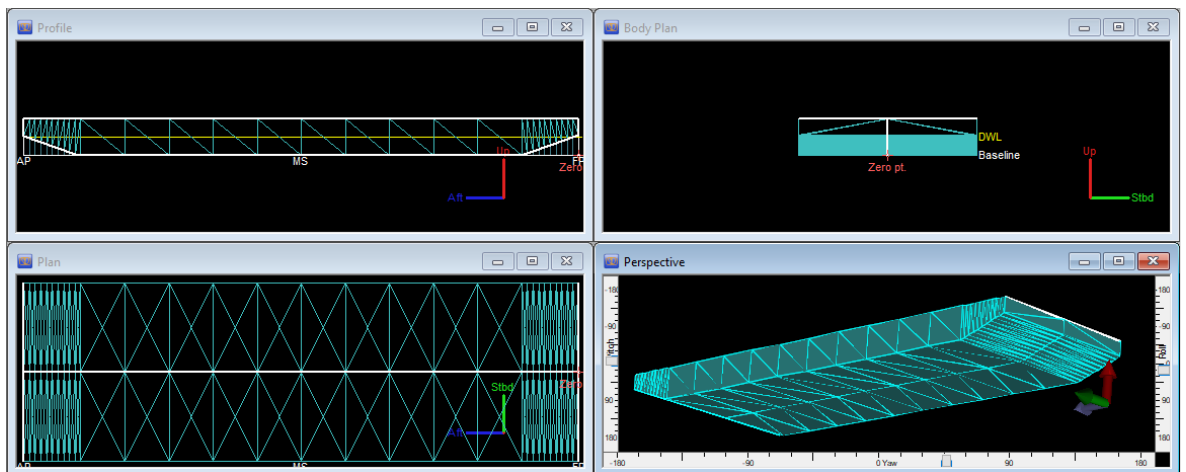

Gambar 4. 6 Permodelan Barge pada MOSES

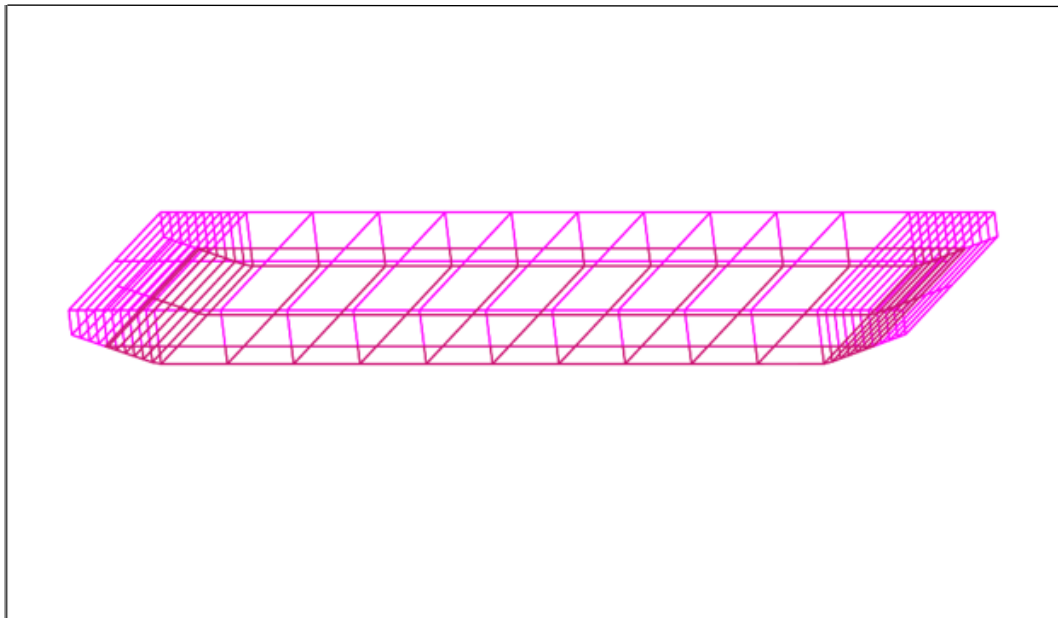

Gambar 4. 7 Permodelan Barge Tampak Isometric

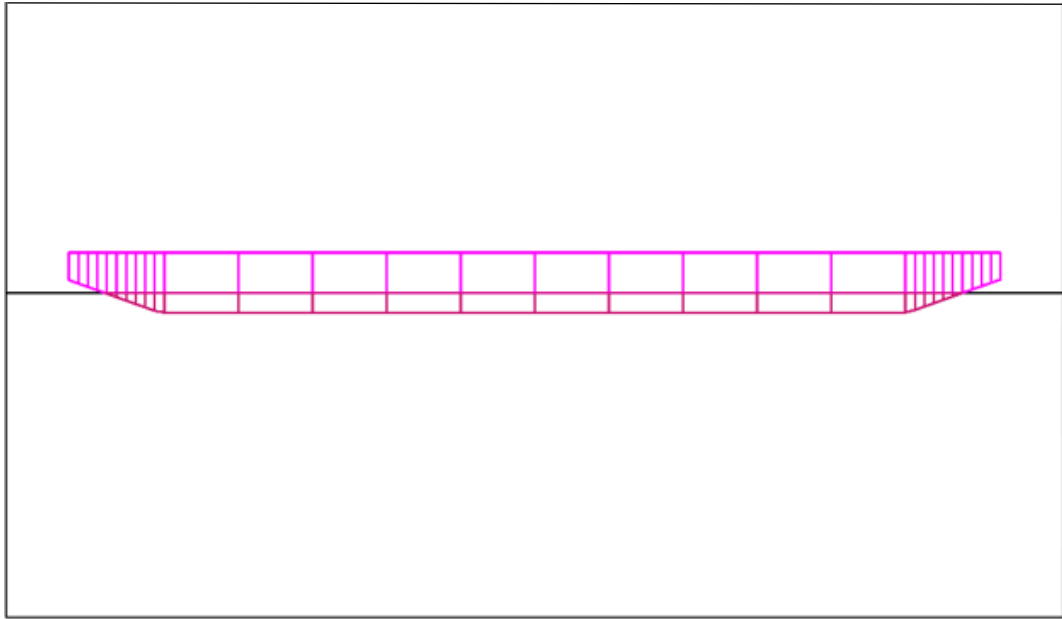

Gambar 4. 8 Permodelan Barge Tampak Samping

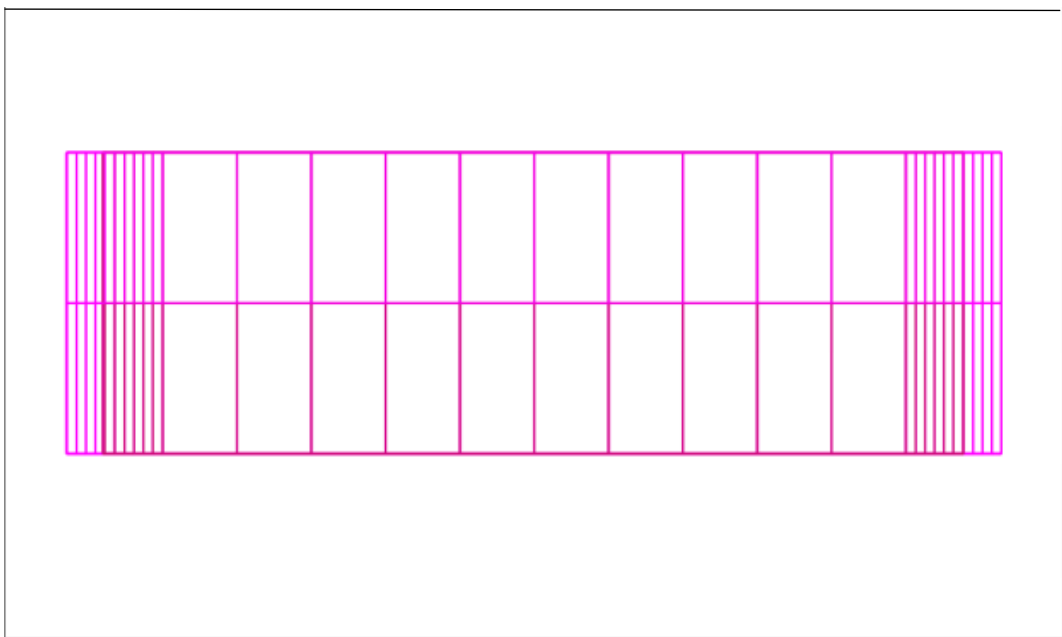

Gambar 4. 9 Permodelan Barge Tampak Atas

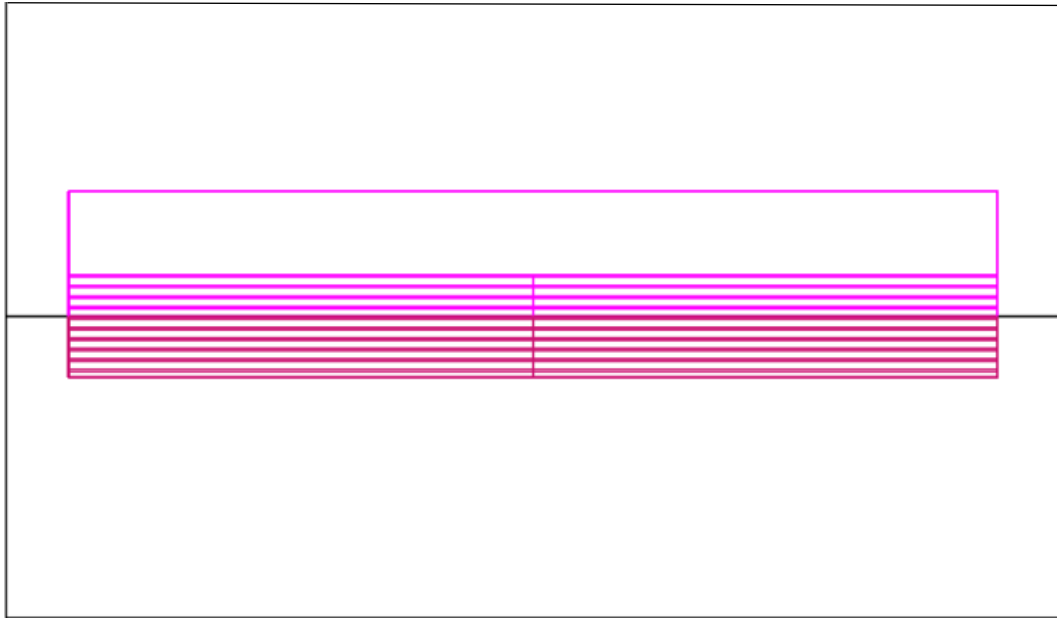

Gambar 4. 10 Permodelan Barge Tampak Bow

Setelah pipe laying barge dimodelkan, selanjutnya dilakukan juga permodelan terhadap mooring system. Dimana mooring ini berguna untuk meredam gerakan dari barge saat proses instalasi berlangsung. Permodelan ini juga dilakukan dengan bantuan *software* MOSES. Berikut merupakan hasil model 3 dimensi dari pemodelan *mooring system* pada *barge* yang diperoleh dari data :

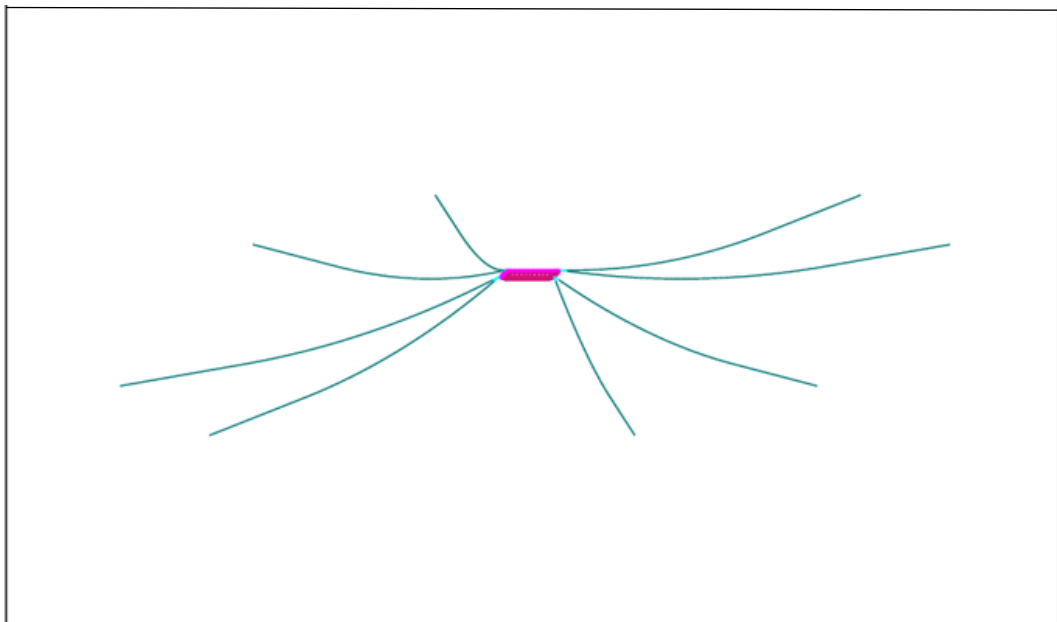

Gambar 4. 11 Permodelan Mooring Barge Tampak Isometri

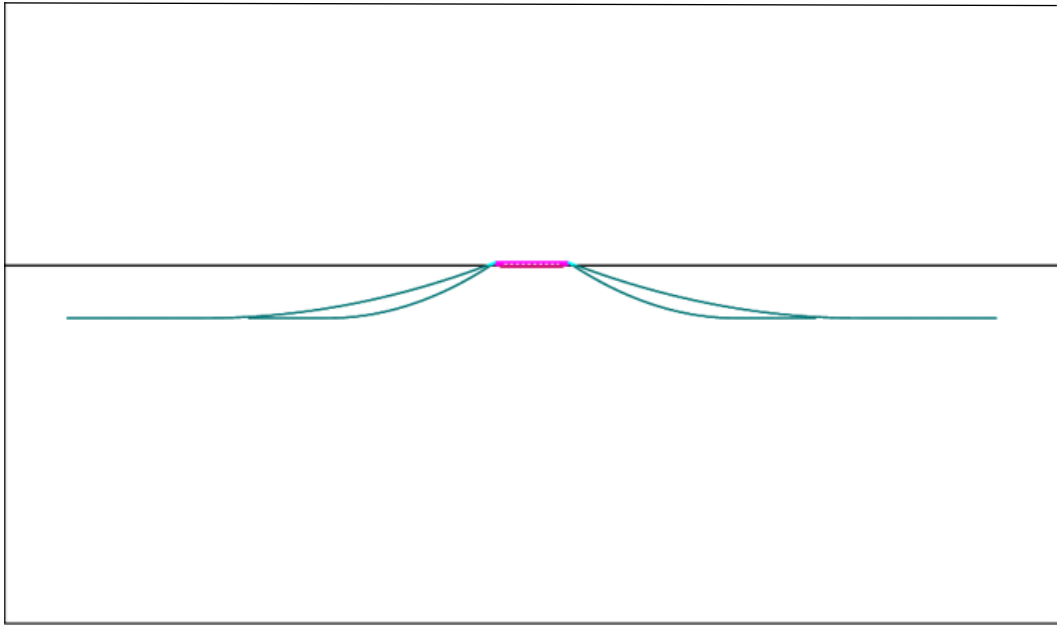

Gambar 4. 12 Permodelan Mooring Barge Tampak Samping

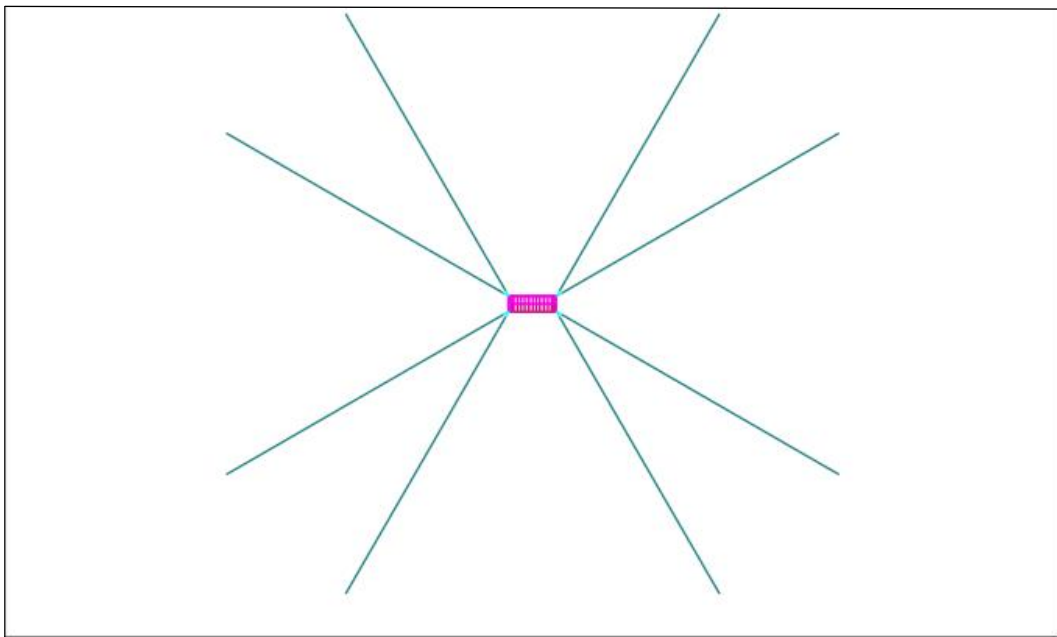

Gambar 4. 13 Permodelan Mooring Barge Tampak Atas

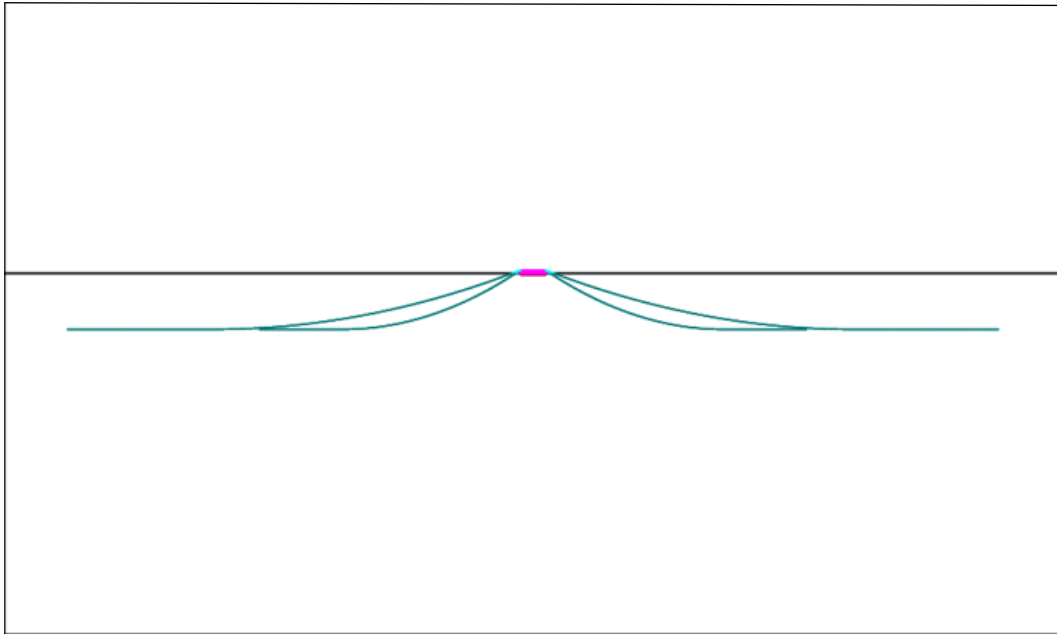

Gambar 4. 14 Permodelan Mooring Barge Tampak Bow

4.5 Analisis *Response Amplitudo Operator* (RAO)

Selanjutnya dilakukan analisa RAO. RAO gerakan barge yang akan dianalisa adalah gerakan lateral (surge, sway, heave) dan gerakan rotasional (roll, pitch, yaw). Analisa dilakukan berdasarkan arah pembebanan gelombang yang datang dari arah 0, 45, 90, 135, dan 180 derajat. Berikut merupakan hasil dari Analisa RAO.

4.5.1 Gerakan *Surge*

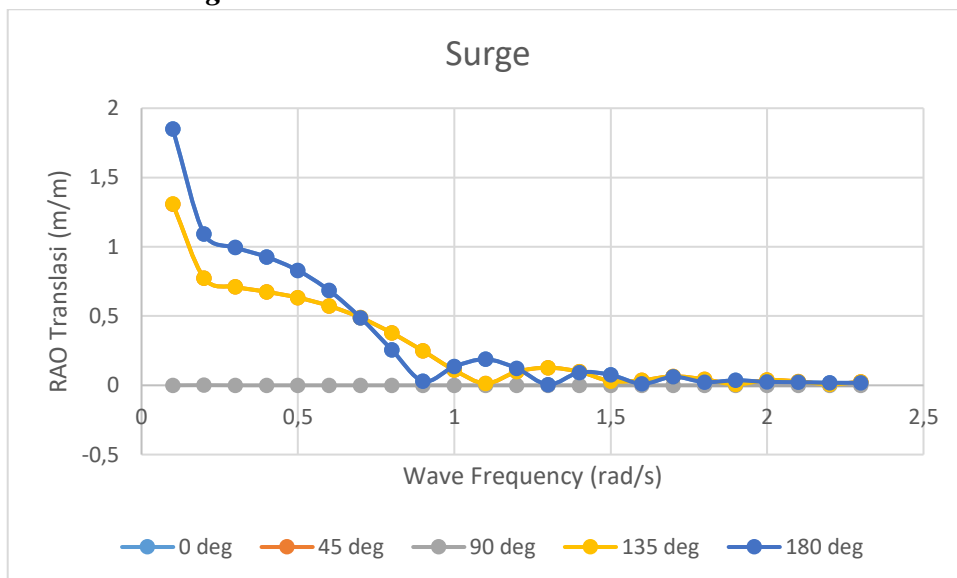

Gambar 4. 15 Grafik RAO Gerakan Surge

Gerakan *surge* adalah gerakan lateral yang terjadi pada sumbu $-x$, menurut hasil analisa, gerakan ini memiliki RAO paling besar terhadap arah pembebanan gelombang yang datang dari arah 0 dan 180 derajat dimana nilai RAO terbesar dari arah tersebut adalah 1.49 m/m dan 1.513 m/m pada frekuensi 0.1 rad/s. Untuk analisis RAO dari arah 45 dan 135 derajat masing-masing nilai RAO terbesar adalah 1.063 m/m dan 1.072 pada frekuensi 0.1 rad/s. Sedangkan pembebanan gelombang dari arah 90 derajat nilai RAO yang terjadi paling besar adalah 0.038 m/m pada frekuensi 0.1 rad/s.

4.5.2 Gerakan *Sway*

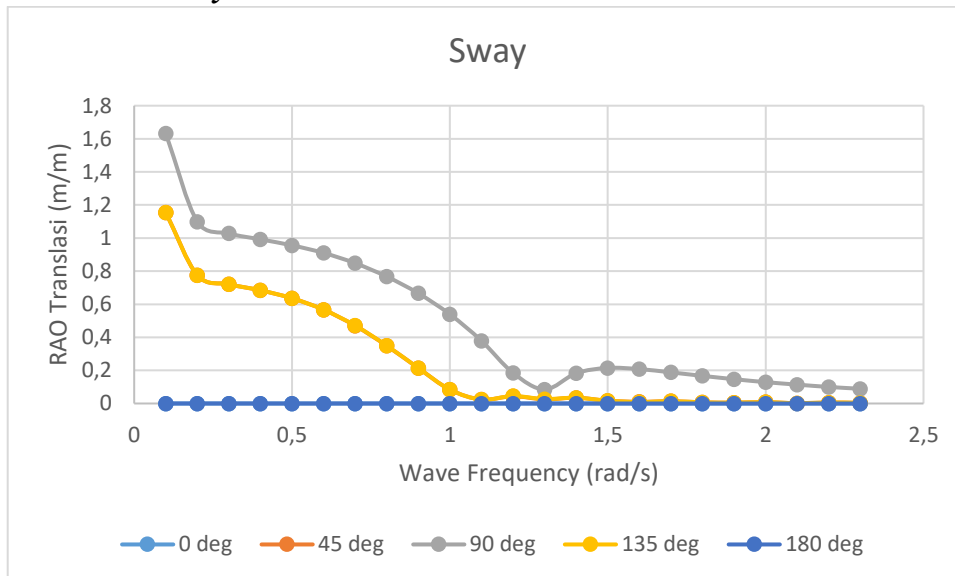

Gambar 4.16 Grafik RAO Gerakan *Sway*

Gerakan *sway* adalah gerakan lateral yang terjadi pada sumbu $-y$, menurut analisis, gerakan ini memiliki RAO paling besar terhadap arah pembebanan gelombang arah 90 derajat dimana nilai RAO terbesar dari arah tersebut adalah 2.069 m/m pada frekuensi 0.1 rad/s. Untuk pembebanan gelombang dari arah 45 dan 135 derajat, nilai RAO terbesar adalah masing-masing 1.762 m/m dan 1.765 pada frekuensi 0.1 rad/s.

4.5.3 Gerakan *Heave*

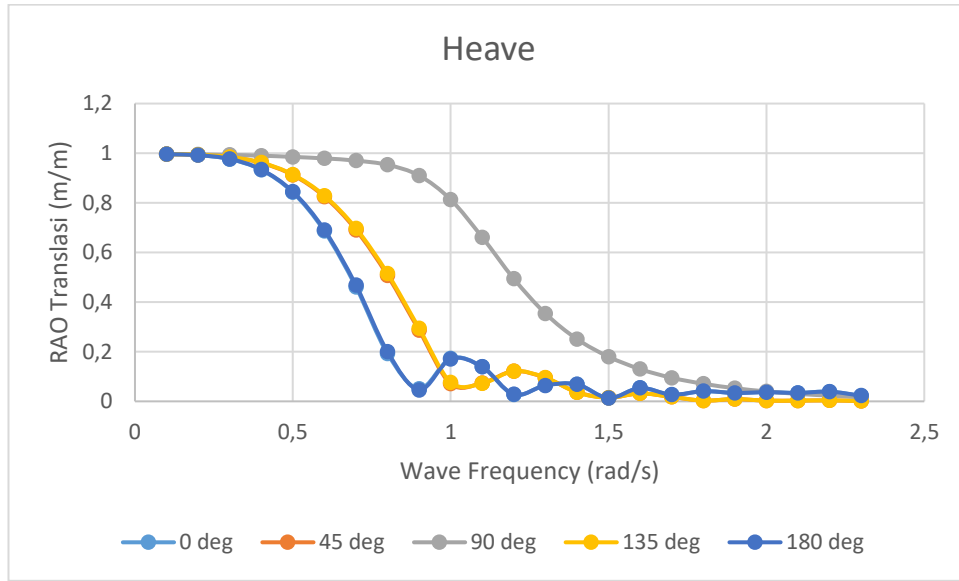

Gambar 4. 17 Grafik RAO Gerakan Heave

Gerakan *heave* adalah gerakan lateral yang terjadi pada sumbu $-z$, menurut hasil analisa, gerakan ini memiliki RAO paling besar terhadap arah pembebanan gelombang arah 90 derajat dimana nilai RAO terbesar dari tersebut adalah 0.99 m/m pada frekuensi 0.2 rad/s. Untuk pembebanan gelombang dari arah 45 dan 135 derajat masing-masing nilai RAO terbesar adalah 0.988 m/m dan 0.988 m/m pada frekuensi 0.1 rad/s. Sedangkan pembebanan gelombang dari arah 0 dan 180 derajat nilai RAO terbesar adalah masing-masing 0.991 m/m dan 0. m/m pada frekuensi 0.991 rad/s

4.5.4 Gerakan *Roll*

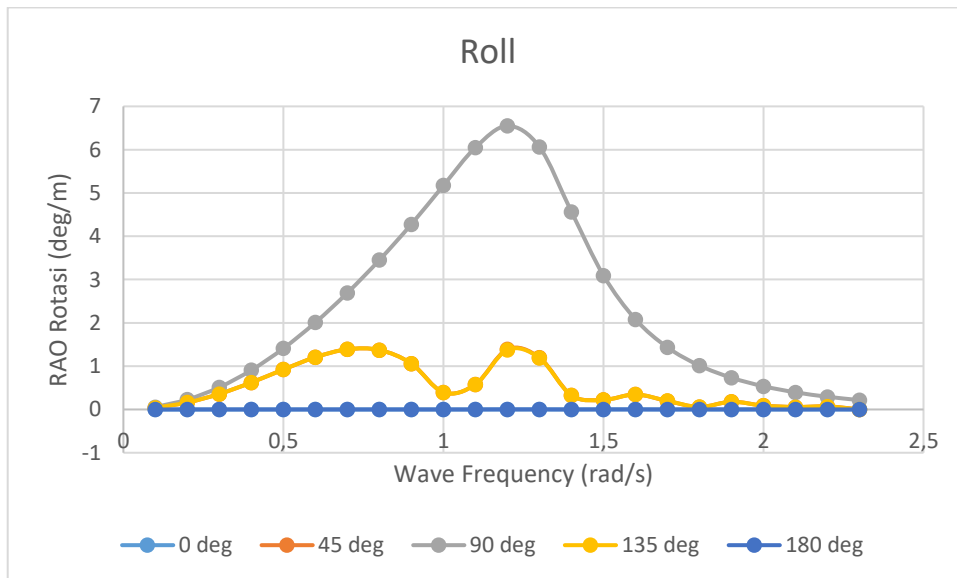

Gambar 4. 18 Grafik RAO Gerakan Roll

Gerakan *roll* merupakan gerakan rotasional yang terjadi pada sumbu $-x$, berdasarkan hasil Analisa, gerakan ini memiliki RAO paling besar terhadap arah pembebanan gelombang yang datang dari arah 90 derajat dimana nilai RAO terbesar dari arah tersebut adalah 6.438 deg/m pada frekuensi 1.2 rad/s. Untuk pembebanan gelombang dari arah 45 dan 135 derajat nilai RAO terbesar adalah masing-masing 1.379 deg/m dan 1.379 deg/m pada frekuensi 0.7 rad/s.

4.5.5 Gerakan *Pitch*

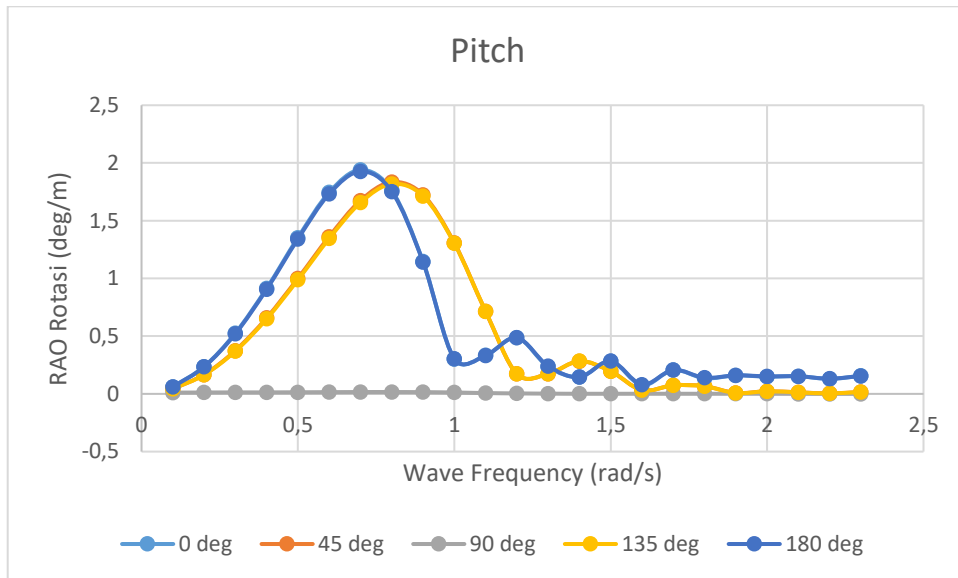

Gambar 4. 19 Grafik RAO Gerakan Pitch

Gerakan *pitch* merupakan gerakan lateral yang terjadi pada sumbu $-y$. berdasarkan hasil Analisa, gerakan ini memiliki RAO paling besar terhadap arah pembebanan gelombang yang datang dari arah 0 dan 180 derajat dimana nilai RAO terbesar dari masing-masing arah tersebut adalah 1.915 deg/m dan 1.902 deg/m pada frekuensi 0.7 rad/s dan 0.7 rad/s. Untuk pembebanan gelombang dari arah 45 dan 135 derajat nilai RAO terbesar adalah masing-masing 1.819 deg/m dan 1.803 deg/m pada frekuensi 0.8 rad/s dan 0.7 rad/s. Sedangkan pembebanan gelombang dari arah 90 derajat nilai RAO yang terjadi sebesar 0.015 deg/m pada frekuensi 0.8 rad/s.

4.5.6 Gerakan Yaw

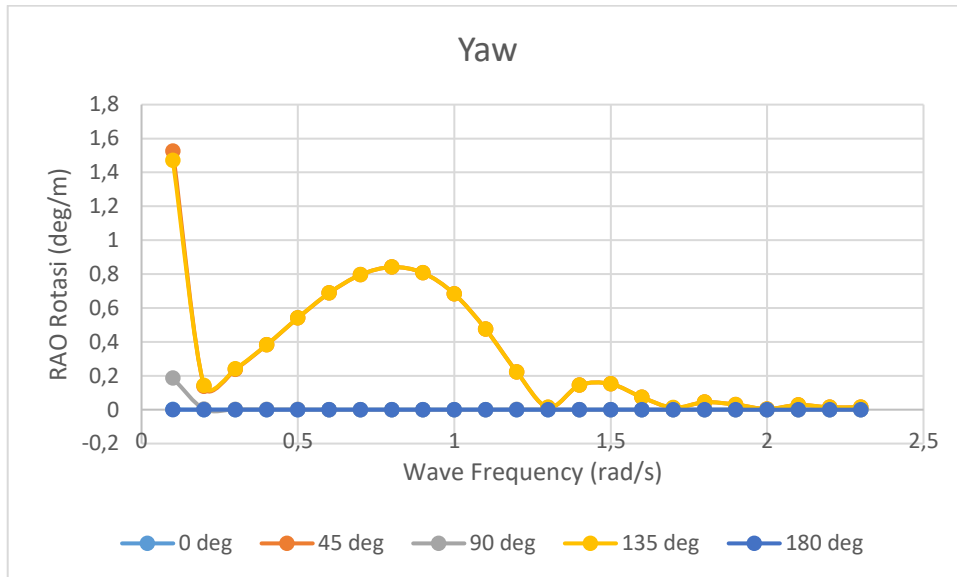

Gambar 4. 20 Grafik RAO Gerakan Yaw

Gerakan *yaw* merupakan gerakan lateral yang terjadi pada sumbu $-z$. berdasarkan hasil Analisa, gerakan ini memiliki RAO paling besar terhadap arah pembebanan gelombang yang datang dari arah 45 dan 135 derajat dimana nilai RAO terbesar dari masing-masing arah tersebut adalah 1.526 deg/m dan 1.471 deg/m pada frekuensi 0.1 rad/s dan 0.1 rad/s. Untuk pembebanan gelombang dari arah 90 derajat nilai RAO terbesar adalah 0.186 deg/m frekuensi 0.1 rad/s. Sedangkan pembebanan gelombang dari arah 0 dan 180 derajat tidak mempengaruhi gerakan ini.

4.6 Analisis Dinamis S-Lay pada Pipa saat Instalasi

Dalam pengerjaan Analisis dinamis instalasi pipa dengan metode S-Lay, dibantu perangkat lunak OFFPIPE 3.02, dengan data-data yang diperlukan sebagai berikut :

- Data Properti Pipa
- Data konfigurasi roller, tensioner, barge dan stinger
- Data kedalaman laut, tinggi gelombang dan arus
- Data parameter spektrum gelombang
- Data *response amplitude operator* (RAO) *pipelaying barge*

Setelah semua data yang diperlukan didapatkan, maka analisis dinamis instalasi pipa dapat dilakukan dengan cara *run program* OFFPIPE dengan arah pembebanan gelombang sebanyak 5, yaitu : 0°, 45°, 90°, 135°, 180°. Untuk melakukan analisis dinamis, *input* yang dimasukkan sama seperti analisis statis tetapi ada penambahan *input* pada bagian *dynamic input*. Dibawah ini merupakan input yang digunakan dalam software OOFFPIPE untuk melakukan analisis dinamis.

Tabel 4. 23 Variabel yang Digunakan untuk Analisis Dinamis

Input & Output	Pipe & Cable	Vessel	Stinger	Sagbend	Dynamic
HEAD	PIPE	BARG	STIN	GEOM	TIME
PRIN	COAT	TENS	SUPP	LENG	WAVE
PROF	CABL	SUPP	SECT	SOIL	SPEC
DNVP	BUND	DAVI	BALL	CURR	RAOS
HIST	MOME	DCAB	BUOY	FLOA	SPTA
APIP	FLUI		WEIG	SPAN	RESP
FATI	OPER				MOTI

Ada 4 variabel waktu yang dimasukkan dalam *software* yaitu waktu dimulai (*sampling start time*), durasi analisis (*solution end time*), interval iterasi (*time step length*) dan waktu interval yang digunakan untuk menampilkan hasil analisis dinamis (*sampling time step*) dimana nilainya 2 kali dari *time step length*. Penulis menggunakan durasi analisis instalasi sebanyak 3 jam atau 10800 detik dengan interval tiap 0.4 detik, seperti pada tabel berikut :

Tabel 4. 24 Variabel Durasi dan Interval Waktu Analisis Dinamis

Description	Value (sec)
Time Step Length	0.4
Solution End Time	10860
Sampling Time Step	0.8
Sampling Start Time	60

Pada analisis dinamis ini penulis menggunakan *Output* dari analisis tersebut adalah berupa total tegangan maksimum yang terjadi pada tiap node pipa sesuai dengan waktu dan beban lingkungan yang diberikan dan juga regangan maksimal

total yang terjadi karena ditinjau dari DNV OS-F101 bahwa batas *allowable strain criteria* nilainya pada saat kondisi dinamis lebih tinggi dibandingkan dengan pada saat kondisi statis yaitu sebesar 0.260%.

Hasil analisis dinamis yang akan ditampilkan dalam penelitian dibagi menjadi 2 yaitu berupa grafik distribusi tegangan maksimal (*maximum dynamic stress distribution*) yang terjadi pada tiap *design case* yang sudah ditentukan. *Output* yang kedua yaitu berupa tabel rangkuman total tegangan pada tiap case yang paling maksimal pada dua titik kritis yaitu *overbend* dan *sagbend*, daerah *overbend*.

4.6.1 Design Case Analisis Dinamis

Design case yang sudah dibuat akan dianalisis sebanyak 5 kali berdasarkan arah pembebanan gelombang yaitu 0°, 45°, 90°, 135°, 180°. Untuk *stress criteria* masih sama dengan analisis statis karena material yang digunakan sama yaitu API 5L Grade X52 dengan SMYS 360 Mpa maka *stress criteria* setara dengan 87% dari SMYS. Sedangkan *strain criteria* yang berlaku untuk analisis dinamis yaitu sebesar 0.260%.

Sebelum memulai pengerjaan analisis dinamis, penulis membuat beberapa *design case* untuk mengetahui variasi apa saja yang akan dilakukan pada analisis dinamis tersebut. Berikut design case yang sudah penulis buat :

Tabel 4. 25 Design case analisis dinamis

Case	Depth	Outside Diameter	Wall Thickness	Stinger Radius of Curvature	Tensioner
	m	Inch	mm	m	ton
1	55,4668	6,625	12,7	200	30
2				300	
3				400	
4				200	35
5				300	
6				400	
7				200	40
8				300	
9				400	

4.6.2 Hasil Analisis Dinamis Total Tegangan Maksimal Arah 0°

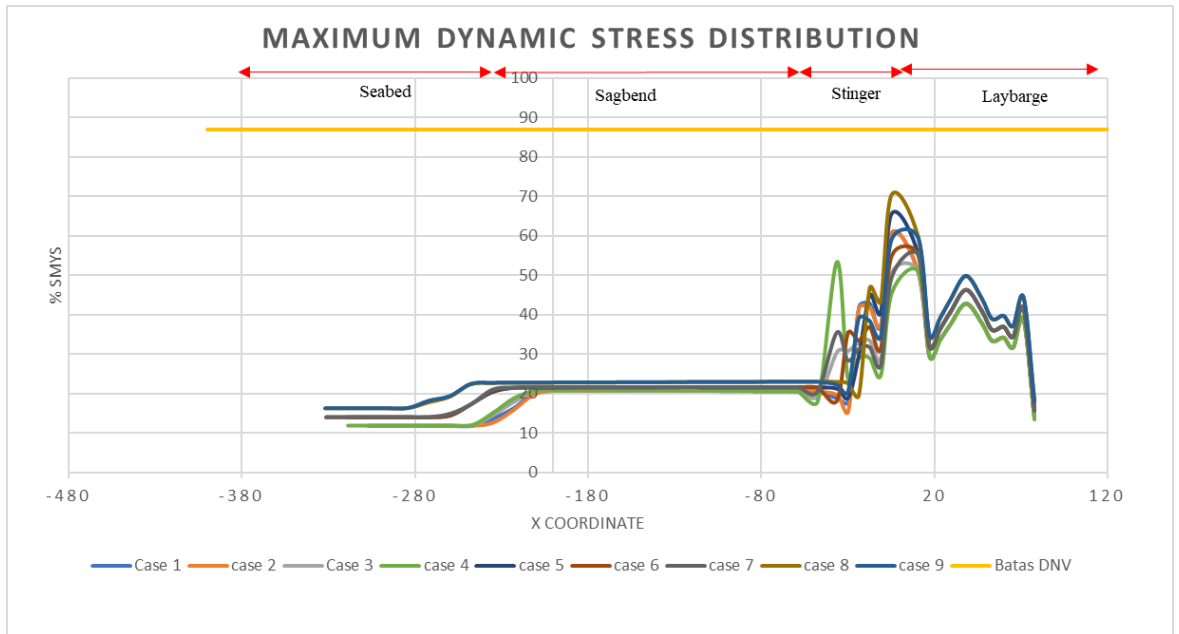

Gambar 4. 21 Distribusi Total Tegangan Dinamis Maksimal Arah 0°

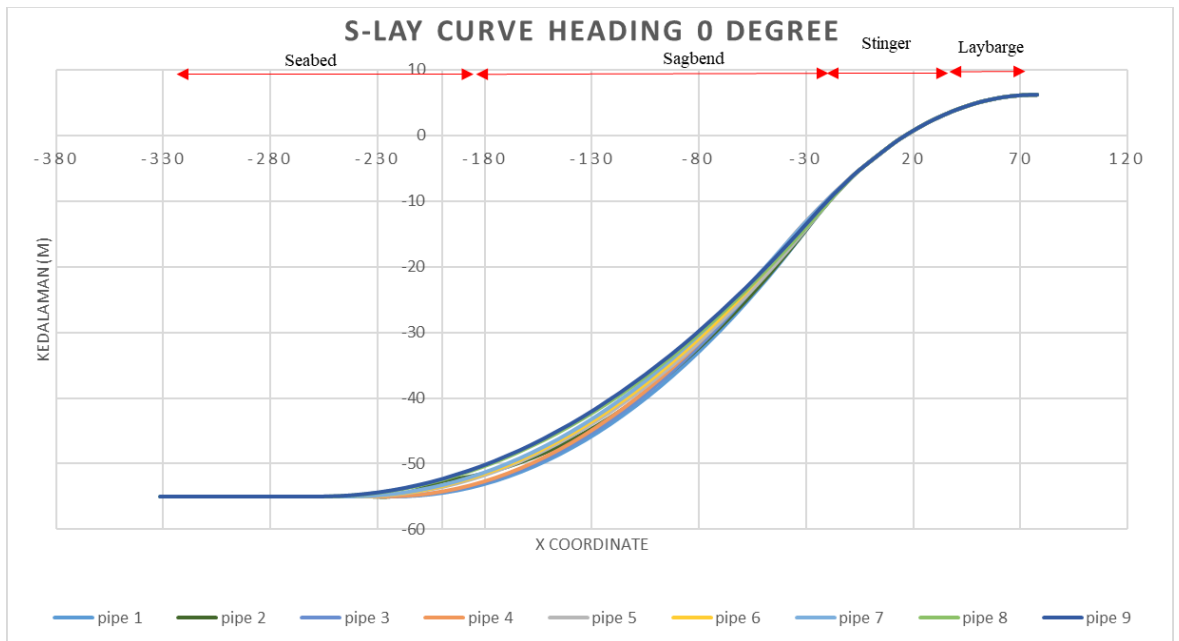

Gambar 4. 22 Kurva S-Lay Dinamis arah 0°

Tabel 4. 26 Hasil Analisis Dinamis Tegangan Arah 0°

Case	Stinger Radius of Curvature	Tensioner	total tegangan				Verify
	m		ton	overbend		sagbend	
		Kpa		%SMYS	Kpa	%SMYS	
1	200	30	218,87	60,8	74,84	20,79	OK
2	300		218,75	60,76	74,94	20,82	OK
3	400		183,05	80,11	74,84	20,79	OK
4	200	35	192,03	53,34	74,87	20,8	OK
5	300		236,44	65,68	78,08	21,69	OK
6	400		198,73	55,2	78,12	21,7	OK
7	200	40	198,49	55,14	78,11	21,7	OK
8	300		253,97	70,55	83,24	23,12	OK
9	400		214,31	59,53	83,17	23,1	OK

Dilihat dari hasil yang telah didapat pada table diatas, analisis tegangan dinamis terbesar yang terjadi pada arah pembebanan 0° adalah pada *case* 8 yaitu sebesar 253,97 mpa atau setara dengan 70,55 % dari SMYS pada daerah *overbend* dengan nomer *node* 24 saat pipa berada tepat diatas ujung *stinger* dimana setelah itu pipa sudah tidak ter-*support* sempurna. Sedangkan pada daerah *sagbend* total tegangan dinamis yang paling besar juga terjadi pada *case* 8 yaitu dengan nilai sebesar 83,2 atau setara dengan 23,12 %SMYS, terjadi pada *node* ke-47. Hasil dari analisis dinamis total tegangan pada arah pembebanan 0 derajat semuanya memenuhi kriteria DNV OS F-101 yaitu tidak boleh lebih dari 87% dari SMYS.

Tabel 4. 27 Hasil Analisis Dinamis Regangan Arah 0°

Case	Total Strain	Allowable Strain Criteria	Verify
	Overbend	%	
	%		
1	0.1023	0.260	OK
2	0.084		OK
3	0.1033		OK
4	0.1091		OK
5	0.0971		OK
6	0.0954		OK
7	0.1162		OK
8	0.1241		OK
9	0.0935		OK
Max =	0.1241		OK

Dilihat dari hasil yang telah didapat pada tabel diatas, analisis regangan dinamis terbesar yang terjadi pada arah pembebanan 0° adalah terjadi pada *case* 8 yaitu sebesar 0.1341%. Lokasinya berada pada *node* pipa ke-34 yang letaknya pada *roller support* terakhir diatas *stinger*. Hasil regangan dinamis maksimal tersebut masih memenuhi batas *allowable strain criteria* yang tercantum pada DNV OS-F101 yaitu dibawah 0.260%

4.6.3 Hasil Analisis Dinamis Total Tegangan Maksimal Arah 45°

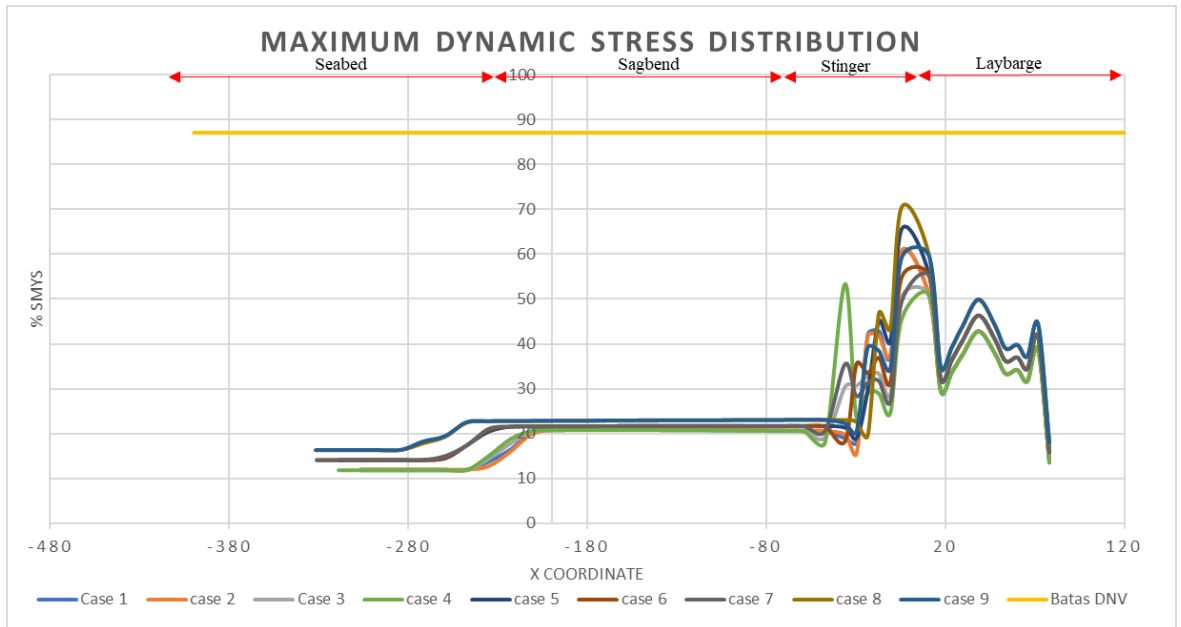

Gambar 4. 23 Distribusi Total Tegangan Dinamis Maksimal Arah 45°

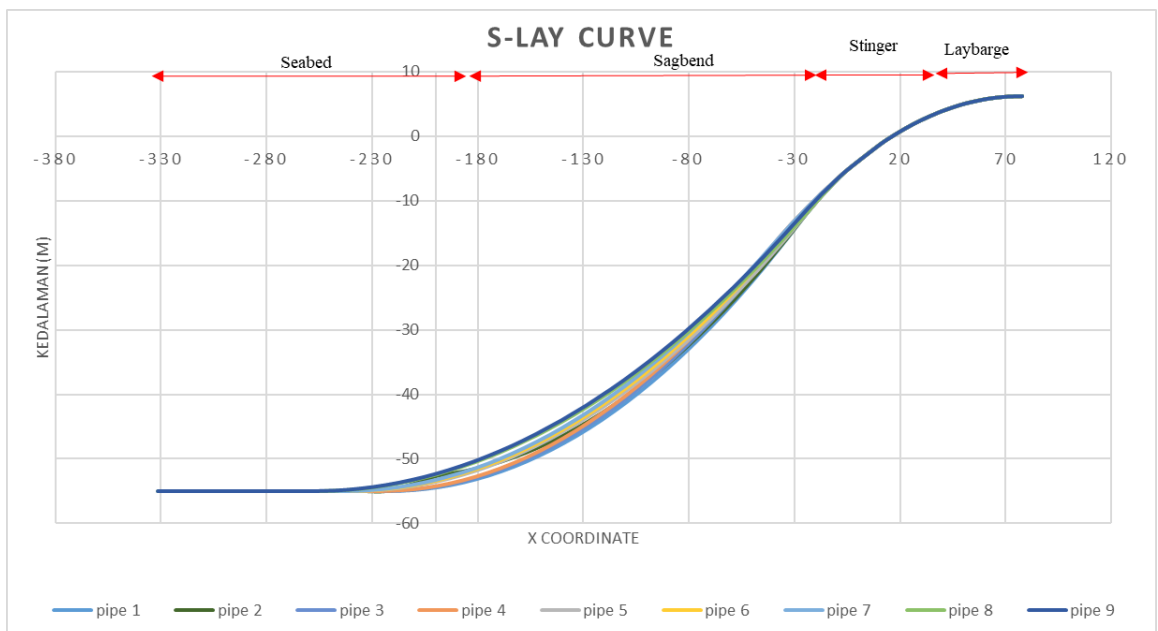

Gambar 4. 24 Kurva S-Lay Dinamis Arah 45°

Tabel 4. 28 Hasil Analisis Dinamis Tegangan Arah 45°

Case	Stinger Radius of Curvature	Tensioner ton	total tegangan				Verify
	m		overbend		sagbend		
			Kpa	%SMYS	Kpa	%SMYS	
1	200	30	218,95	60,82	74,84	20,78	OK
2	300		218,82	60,78	74,97	20,83	OK
3	400		183,18	50,88	74,91	20,81	OK
4	200	35	191,8	53,28	74,87	20,8	OK
5	300		236,35	65,65	78,1	21,69	OK
6	400		198,63	55,18	78,06	21,68	OK
7	200	40	198,51	55,14	78,14	21,71	OK
8	300		254,16	70,6	83,32	23,14	OK
9	400		214,32	59,53	83,17	23,1	OK

Dilihat dari grafik dan tabel diatas, dapat diketahui bahwa tegangan maksimum yang terjadi pada arah pembebanan 45° adalah pada *case* 8 yaitu sebesar 254.16 mpa atau setara dengan 70.6% dari SMYS pada daerah *overbend* dengan nomer *node* 24. Untuk daerah *sagbend case* total tegangan dinamis yang paling besar juga terjadi pada *case* 8 yaitu dengan nilai sebesar 83.3 atau setara dengan 23.14 %SMYS, terjadi pada *node* ke-48. Hasil dari analisis dinamis total tegangan pada arah pembebanan 45 derajat semuanya memenuhi kriteria DNV OS F-101 yaitu tidak boleh lebih dari 87% dari SMYS.

Tabel 4. 29 Hasil Analisis Dinamis Regangan Arah 45°

Case	Total Strain	Allowable Strain Criteria	Verify
	Overbend	%	
	%		
1	0.1136	0.260	OK
2	0.0828		OK
3	0.1021		OK
4	0.1079		OK
5	0.0923		OK
6	0.0947		OK
7	0.114		OK
8	0.1342		OK
9	0.091		OK
Max =	0.1342		OK

Dilihat dari hasil yang telah didapat pada tabel diatas, analisis regangan dinamis terbesar yang terjadi pada arah pembebanan 45° dapat diketahui bahwa tegangan maksimal yang terjadi adalah pada *case* 8 yaitu sebesar 0.1336%.

4.6.4 Hasil Analisis Dinamis Total Tegangan Maksimal Arah 90°

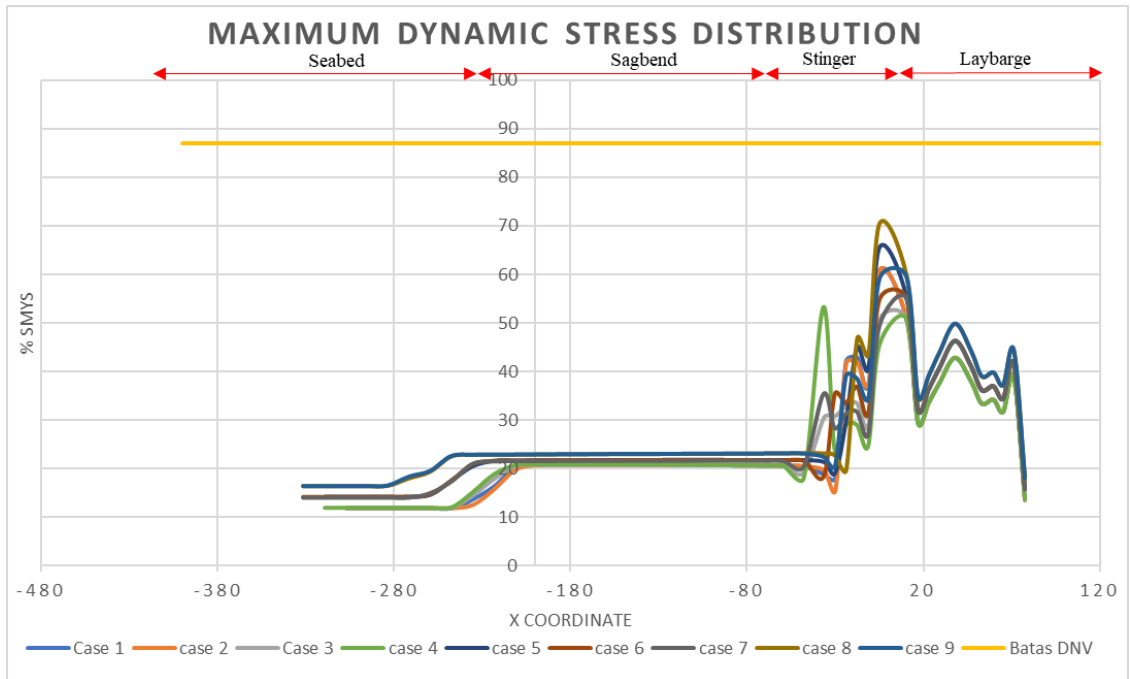

Gambar 4. 25 Distribusi Total Tegangan Dinamis Maksimal Arah 90°

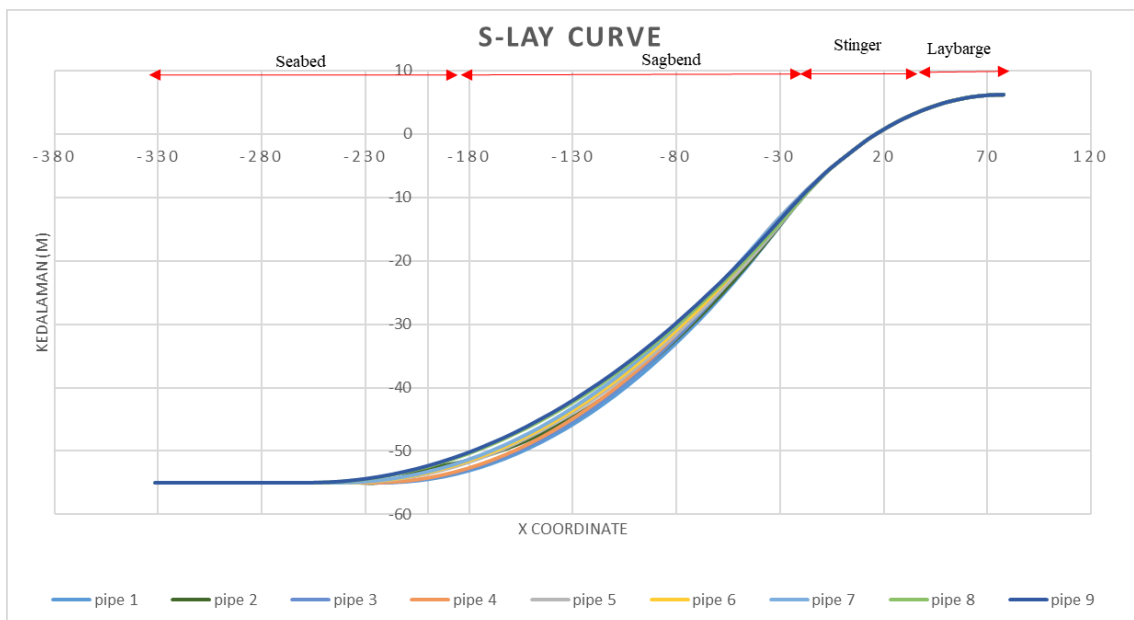

Gambar 4. 26 Kurva S-Lay Dinamis Arah 90°

Tabel 4. 30 Hasil Analisis Dinamis Tegangan Arah 90 °

Case	Stinger Radius of Curvature	Tensioner ton	total tegangan				Verify
	m		overbend		sagbend		
			Kpa	%SMYS	Kpa	%SMYS	
1	200	30	218,89	60,82	74,84	20,78	OK
2	300		219,01	60,78	74,97	20,79	OK
3	400		183,3	50,92	37,82	20,18	OK
4	200	35	183,16	50,88	37,76	20,21	OK
5	300		236,49	65,69	29,93	30,18	OK
6	400		198,71	55,2	30,87	20,77	OK
7	200	40	198,48	55,13	31,12	20,6	OK
8	300		253,99	70,55	25,43	30,02	OK
9	400		214,26	59,52	25,67	20,94	OK

Dilihat dari hasil yang telah didapat pada table diatas, analisis tegangan dinamis terbesar yang terjadi pada arah pembebanan 90° adalah pada *case* 8 sebesar 253,99 Mpa atau sebesar 70,55% dari SMYS pada daerah *overbend* dengan nomer *node* 34 lokasinya adalah saat pipa berada tepat diatas ujung *stinger* dimana setelah itu pipa sudah tidak *ter-support* sempurna. Untuk daerah *sagbend* total tegangan dinamis yang paling besar adalah pada *case* 2 yaitu dengan nilai sebesar 77,84 Mpa atau setara dengan 20,78% dari SMYS, terjadi pada *node* ke-47. Hasil dari analisis dinamis total tegangan pada arah pembebanan 90 derajat semuanya memenuhi kriteria DNV OS F-101 yaitu tidak boleh lebih dari 87% dari SMYS.

Tabel 4. 31 Hasil Analisis Dinamis Regangan Arah 90°

Case	Total Strain	Allowable Strain Criteria	Verify
	Overbend	%	
	%		
1	0.1032	0.260	OK
2	0.0835		OK
3	0.1034		OK
4	0.1099		OK
5	0.0931		OK
6	0.0949		OK
7	0.1018		OK
8	0.1237		OK
9	0.0927		OK
Max =	0.1377		OK

Dilihat dari hasil yang telah didapat pada tabel diatas, analisis regangan dinamis terbesar yang terjadi pada arah pembebanan 90° adalah pada *case* 8 yaitu sebesar 0.1377%. Hasil regangan dinamis maksimal tersebut masih memenuhi batas *allowable strain criteria* yang tercantum pada DNV OS-F101 yaitu dibawah 0.260%

4.6.5 Hasil Analisis Dinamis Total Tegangan Maksimal Arah 135°

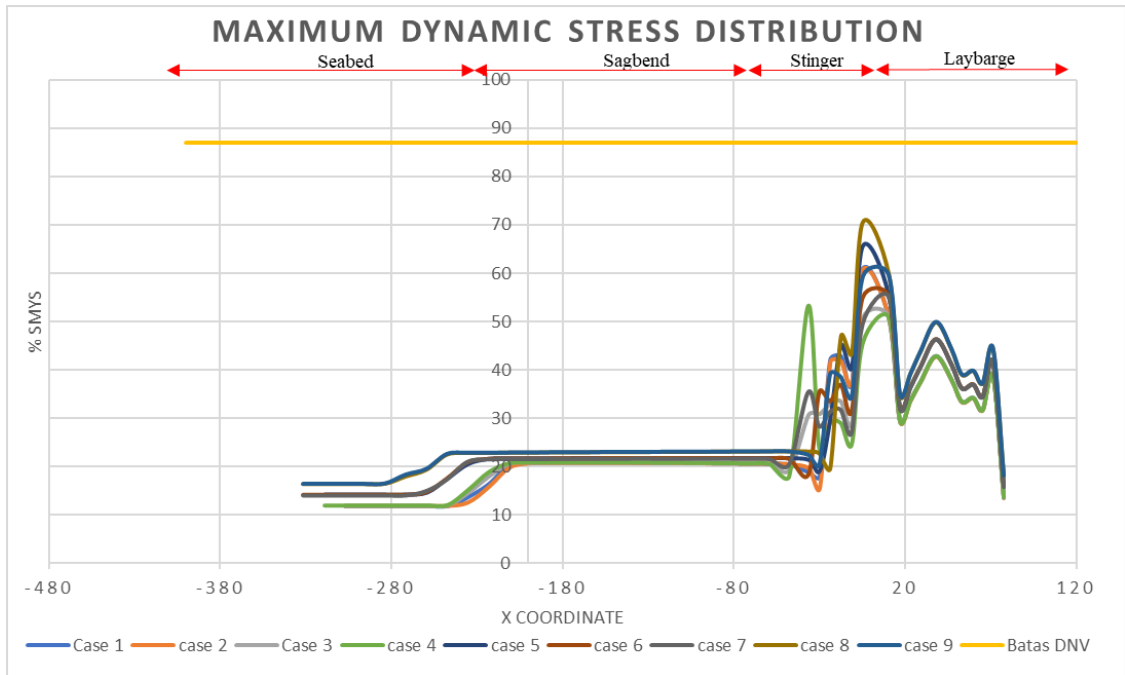

Gambar 4. 27 Distribusi Total Tegangan Dinamis Maksimal Arah 135°

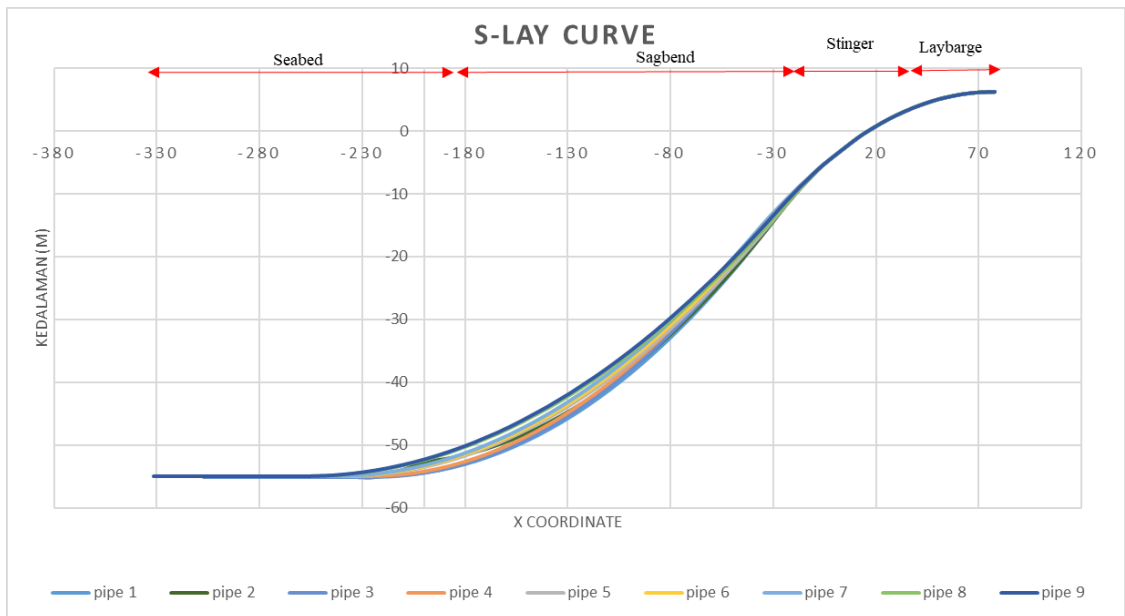

Gambar 4. 28 Kurva S-Lay Dinamis Arah 135°

Tabel 4. 32 Hasil Analisis Dinamis Tegangan Arah 135°

Case	Stinger Radius of Curvature	Tensioner ton	total tegangan				Verify
	m		overbend		sagbend		
			Kpa	%SMYS	Kpa	%SMYS	
1	200	30	219	60,82	74,84	20,8	OK
2	300		218,9	60,78	74,97	20,79	OK
3	400		183	50,84	38,01	20,1	OK
4	200	35	183	50,9	37,99	20,13	OK
5	300		236	65,7	30,25	30,05	OK
6	400		199	55,2	31,11	20,58	OK
7	200	40	198,5	55,14	31,35	20,4	OK
8	300		215,5	59,86	25,69	20,91	OK
9	400		214,2	-4,23	25,9	20,82	OK

Dilihat dari hasil yang telah didapat pada table diatas, analisis tegangan dinamis terbesar yang terjadi pada arah pembebanan 135° adalah pada *case* 5 yaitu sebesar 236,4 Mpa atau setara dengan 65,7 % dari SMYS pada daerah *overbend* dengan nomer *node* 24. Untuk daerah *sagbend* total tegangan dinamis yang paling besar adalah pada *case* 2 yaitu dengan nilai sebesar 74,97 atau setara dengan 20,79% dari SMYS, terjadi pada *node* ke-47. Hasil dari analisis dinamis total tegangan pada arah pembebanan 135 derajat semuanya memenuhi kriteria DNV OS F-101 yaitu tidak boleh lebih dari 87% dari SMYS.

Tabel 4. 33 Hasil Analisis Dinamis Regangan Arah 135°

Case	Total Strain	Allowable Strain Criteria	Verify
	Overbend	%	
	%		
1	0.1031	0.260	OK
2	0.0889		OK
3	0.1126		OK
4	0.1109		OK
5	0.1292		OK
6	0.0936		OK
7	0.1073		OK
8	0.0935		OK
9	0.0977		OK
Max =	0.1392		OK

Dilihat dari hasil yang telah didapat pada table diatas, analisis regangan dinamis terbesar yang terjadi pada arah pembebanan 135° adalah pada *case 5* yaitu sebesar 0.1392%. Lokasinya berada pada *node* pipa ke-34 yang letaknya pada *roller support* terakhir diatas *stinger*. Namun demikian, hasil regangan dinamis maksimal tersebut masih memenuhi batas *allowable strain criteria* yang tercantum pada DNV OS-F101 yaitu dibawah 0.260%

4.6.6 Hasil Analisis Dinamis Total Tegangan Maksimal Arah 180°

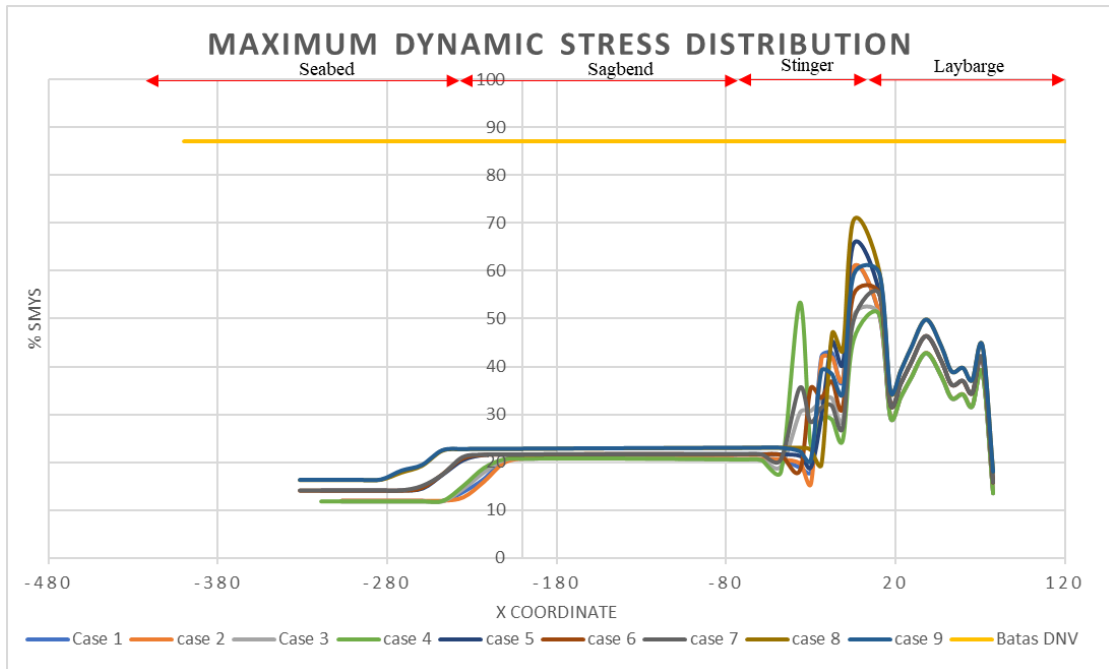

Gambar 4. 29 Distribusi Total Tegangan Dinamis Maksimal Arah 180°

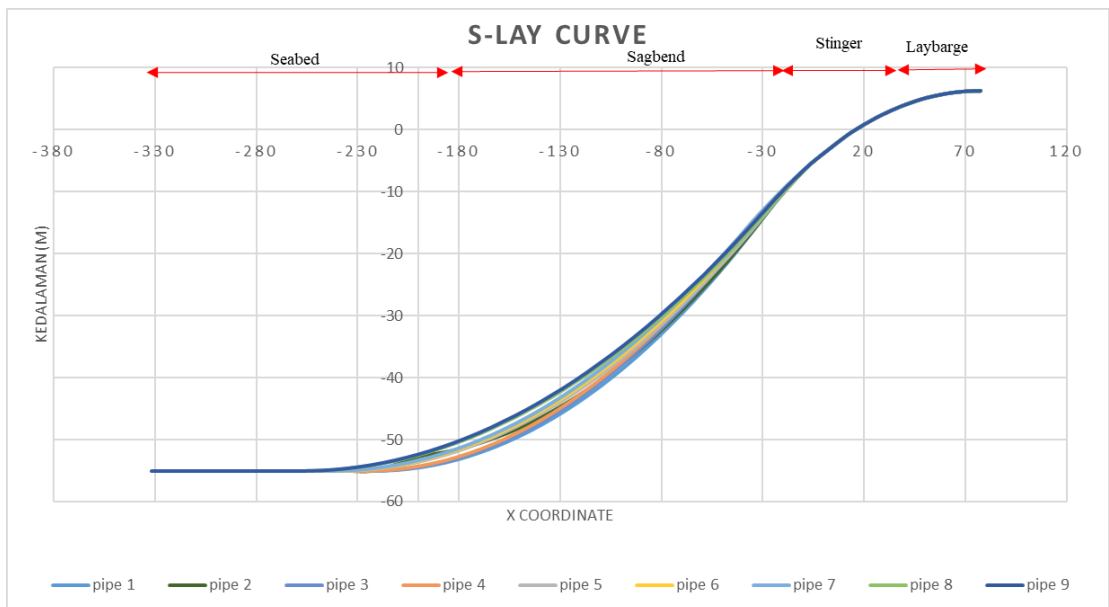

Gambar 4. 30 Kurva S-Lay Dinamis Arah 180°

Tabel 4. 34 Hasil Analisis Dinamis Tegangan Arah 180°

Case	Stinger Radius of Curvature	Tensioner ton	total tegangan				Verify
	m		overbend		sagbend		
			Kpa	%SMYS	Kpa	%SMYS	
1	200	30	218,91	60,81	74,84	20,78	OK
2	300		218,76	60,77	74,97	20,78	OK
3	400		183,12	50,86	38,01	20,09	OK
4	200	35	183,11	50,85	37,99	20,13	OK
5	300		236,38	65,66	30,25	30,05	OK
6	400		198,87	55,24	31,16	20,58	OK
7	200	40	198,39	55,11	31,32	20,4	OK
8	300		254,12	70,59	25,69	20,91	OK
9	400		214,18	59,5	25,9	20,82	OK

Dilihat dari hasil yang telah didapat pada tabel diatas, analisis tegangan dinamis terbesar yang terjadi pada arah pembebanan 180° adalah pada *case* 8 yaitu sebesar 254,1 atau setara dengan 70,59% dari SMYS pada daerah *overbend* dengan nomer *node* 24. Untuk daerah *sagbend* total tegangan dinamis yang paling besar adalah pada *case* 2 juga yaitu dengan nilai sebesar 75,0 atau setara dengan 20,78% dari SMYS, terjadi pada *node* ke-48. Hasil dari analisis dinamis total tegangan pada arah pembebanan 180 derajat semuanya memenuhi kriteria DNV OS F-101 yaitu tidak boleh lebih dari 87% dari SMYS.

Tabel 4. 35 Hasil Analisis Dinamis Regangan Arah 180°

Case	Total Strain	Allowable Strain Criteria	Verify
	Overbend	%	
	%		
1	0.1023	0.260	OK
2	0.0831		OK
3	0.1033		OK
4	0.1091		OK
5	0.0938		OK
6	0.0945		OK
7	0.1133		OK
8	0.1243		OK
9	0.0954		OK
Max =	0.1343		OK

Dilihat dari hasil yang telah didapat pada table diatas, analisis regangan dinamis terbesar yang terjadi pada arah pembebanan 180° adalah pada *case* 8 yaitu sebesar 0.1343%. Lokasinya berada pada *node* pipa ke-34 yang letaknya pada *roller support* terakhir diatas *stinger*. Hasil regangan dinamis maksimal tersebut masih memenuhi batas *allowable strain criteria* yang tercantum pada DNV OS-F101 yaitu dibawah 0.260%

Perbedaan antara Analisa statis dan dinamis terletak pada data dan parameter yang di analisis, dimana pada analisis statis barge dianggap dalam keadaan statis atau diam (tidak terpengaruh gelombang) sedangkan dalam analisis dinamis barge dianalisis dalam keadaan terpengaruh gelombang. Hal ini juga dapat mempengaruhi dimana hasil akhir dari analisis dinamis memiliki nilai yang lebih kecil dari analisis statis. Hal ini disebabkan oleh sifat dari gelombang itu sendiri sehingga hasilnya bisa lebih besar ataupun lebih kecil dari analisis statis tergantung kondisi lingkungan yang berlaku (DNV OS F-101).

BAB V PENUTUP

5.1 Kesimpulan

Berdasarkan analisis yang dilakukan pada penelitian ini, maka dapat diambil kesimpulan mengenai penelitian tugas akhir ini, sebagai berikut :

1. Hasil analisa statis S-Lay yang sudah dilakukan oleh penulis dengan variasi yang sesuai dengan *design case*. Dapat dilihat bahwa total tegangan yang paling besar terjadi adalah pada *case 6* dengan variasi tension sebesar 35 ton dan *radius of curvature* sepanjang 400 meter dengan besar total tegangan sebesar 321,29 MPa atau sebesar 85,69 % dari SMYS. Pada *case* ini total stress masih dibawah nilai total stress yang diijinkan oleh DNV OS F101 yaitu harus dibawah 87% SMYS.
2. Hasil analisis dinamis instalasi pipa dengan total tegangan dinamis terbesar terjadi pada *case 8* pada arah pembebanan 45° yaitu sebesar 254,16 Mpa atau setara 70,6% dari SMYS pipa berdiameter 6 inch. Untuk regangan dinamis pipanya yang paling besar juga terletak pada *case 8* dengan arah pembebanan 135° dengan nilai sebesar 0.1392%. Hasil tegangan dan regangan dinamis yang terjadi masih dibawah batas *allowable stress strain criteria* yang tercantum pada DNV OS-F101.
3. Dapat Disimpulkan bahwa konfigurasi *stinger radius of curvature*, dan kekuatan *tensioner* yang paling optimal mengacu pada analisis statis dan dinamis yang sudah dilakukan adalah *case 3* dengan konfigurasi kedalaman 55 meter, *stinger radius of curvature* sebesar 400 meter dan kekuatan *tensioner* sebesar 30 ton. Konfigurasi tersebut memiliki hasil total tegangan analisis statis dan dinamis yang paling kecil dari hasil variasi lainnya. Dengan demikian, variabel variasi *case 3* dapat dianjurkan pada saat melakukan instalasi pipa 6 inch pada keadaan lingkungan yang sudah ditentukan. Namun, jika harus menggunakan beberapa variasi lain yang penulis sebutkan dalam penelitian ini, masih dapat digunakan dalam instalasi pipa 6 inch pada keadaan lingkungan yang sudah ditentukan karena semua hasil total tegangan dan regangan dalam penelitian ini masih dibawah batas yang diijinkan oleh DNV OS-F101.

5.2 Saran

Adapun saran yang dapat diberikan oleh penulis untuk penelitian selanjutnya yaitu :

1. Diperlukan *mooring analysis* pada saat instalasi berlangsung.
2. Penelitian ini hanya menggunakan sebanyak 5 *heading* saja dalam analisis dinamisnya, diharapkan dapat menambahkan arah pembebanan sehingga penelitian yang dilakukan semakin detail.
3. Diperlukan hasil permodelan berupa respon gerak barge agar lebih akurat.

DAFTAR PUSTAKA

- Aristanto, Wahyu Dwi. 2007. **Analisa Tegangan Pipa Bawah Laut Selama Proses *Above water Tie-In***. Tugas Akhir. Surabaya : Departemen Teknik Kelautan. Fakultas Teknologi Kelautan. Institut Teknologi Sepuluh Nopember.
- ASME B31.4. 2016. ***Pipeline Transportation Systems for Liquids and Slurries***. American Society of Mechanical Engineer. New York.
- Bai, Qiang., Bai, Yong. 2014. ***Subsea Pipeline Design, Analysis, and Installation***. Oxford : Elsevier
- DNV OS-F101. 2013. ***Submarine Pipeline Systems***. Det Norske Veritas AS.Norway.
- Fathurozi, Muhammad. 2016. **Analisis Tegangan Pipa saat *Pulling* pada Instalasi *Pipeline* dengan Metode *Push Pull* : Project PT. Dwisatu Mustika Bumi (DMB)**. Tugas Akhir. Surabaya : Departemen Teknik Kelautan. Fakultas Teknologi Kelautan. Institut Teknologi Sepuluh Nopember.
- Guo, Boyun. 2014. ***Offshore Pipelines Design, Installation and Maintenance***. Oxford : Elsevier.
- Handono, Tri. 2007. **Analisa Dinamis Rancangan Modifikasi Pipa Penyalur Dermaga PT. Pertamina Balikpapan**. Tugas Akhir. Surabaya : Departemen Teknik Kelautan. Fakultas Teknologi Kelautan. Institut Teknologi Sepuluh Nopember.
- Khanifudin, Ibnu. 2015. **Analisis *Ultimate Limit State (ULS)* Pada *Free Span* (Kasus : South Sumatra West Java Gas Pipeline Project Phase II Labuhan Maringgai-Muara Bekasi *Offshore Pipeline*)**. Tugas Akhir. Surabaya : Departemen Teknik Kelautan. Fakultas Teknologi Kelautan. Institut Teknologi Sepuluh Nopember.

- Makisang, David. 2007. **Analisa Hidrodinamika Pipeline Selama Instalasi Dengan Metode Tow Surface**. Tugas Akhir. Surabaya : Departemen Teknik Kelautan. Fakultas Teknologi Kelautan. Institut Teknologi Sepuluh Nopember.
- Mouselli, A.H.1981. *Offshore Design, Analysis and Methods*. Penwell Books, Oklahoma.
- Musya, Novella. 2013. **Analisa Stabilitas Crossing Pipeline Antara Trunk Line Petronas Dengan Existing Line Kodeco Energy**. Tugas Akhir. Surabaya : Departemen Teknik Kelautan. Fakultas Teknologi Kelautan. Institut Teknologi Sepuluh Nopember.
- Nugroho, Riki Satrio. 2010. **Analisa Instalasi Pipa Polyethylene Bawah Laut Dengan Metode S-Lay**. Tugas Akhir. Surabaya : Departemen Teknik Kelautan. Fakultas Teknologi Kelautan. Institut Teknologi Sepuluh Nopember.
- Purnama, IB. MD. Addy. 2006. **Analisa Tegangan Pipa Bawah Laut Pada Proses Instalasi Akibat Gerakan Lay Barge Dengan Metode S-Lay**. Tugas Akhir. Surabaya : Departemen Teknik Kelautan. Fakultas Teknologi Kelautan. Institut Teknologi Sepuluh Nopember.
- Rasyadi, Muhammad Zaki. 2019. **Analisis Proses Initiation Dan Laydown Pada Pipa Saat Instalasi Dengan Metode S-Lay**. Tugas Akhir. Surabaya : Departemen Teknik Kelautan. Fakultas Teknologi Kelautan. Institut Teknologi Sepuluh Nopember.
- Rizaldy C, M, Armando. 2008. **Analisa Buckling Pada Saat Instalasi Pipa Bawah Laut Studi Kasus Saluran Pipa “Karmila-Titi” Milik Cnooc Di Offshore South East Sumatra**. Tugas Akhir. Surabaya : Departemen Teknik Kelautan. Fakultas Teknologi Kelautan. Institut Teknologi Sepuluh Nopember.

LAMPIRAN

LAMPIRAN A
OUTPUT SOFTWARE OFFPIPE
(ANALISIS STATIS)

OUTPUT ANALISIS STATIS CASE (1-9)

OFFPIPE - OFFSHORE PIPELINE ANALYSIS SYSTEM - VERSION 2.05 AC DATE - 4/20/2020 TIME - 22:41:42 PAGE 86

PROJECT - TUGAS AKHIR JOB NO. ANALISIS STATIS

USER ID - IIDA BAGUS FUNDHARA SAKYANARY LICENSED TO: RICKY TAMEKAL CASE 1

STATIC PIPE COORDINATES, FORCES AND STRESSES

NODE NO.	PIPE SECTION	X	Y	Z	HORIZ	VERT	PIPE	TENSILE	HOOP	BENDING STRESSES		TOTAL	PERCNT
		COORD (M)	COORD (M)	COORD (M)	ANGLE (DEG)	ANGLE (DEG)	LENGIH (M)	STRESS (MPA)	STRESS (MPA)	VERT (MPA)	HORIZ (MPA)	STRESS (MPA)	YIELD (PCT)
1	TENSIONR	77.79	6.21	.00	.000	.255	.000	13.33	.00	.00	.00	48.33	13.43
3	LAYBARGE	71.49	6.17	.00	.000	.713	6.300	13.32	.00	-84.23	-.01	132.54	36.82
5	LAYBARGE	65.37	6.04	.00	.000	1.664	12.416	13.30	.00	-60.03	.00	108.33	30.09
7	LAYBARGE	59.91	5.84	.00	.000	2.476	17.883	13.27	.00	-69.05	.00	117.32	32.59
9	LAYBARGE	53.32	5.51	.00	.000	3.357	24.482	13.22	.00	-66.17	.00	114.39	31.77
11	LAYBARGE	47.32	5.11	.00	.000	4.344	30.493	13.15	.00	-82.84	.00	130.99	36.39
13	LAYBARGE	38.21	4.33	.00	.000	5.557	39.635	13.02	.00	-100.98	-.01	149.01	41.39
15	LAYBARGE	29.27	3.35	.00	.000	6.775	48.632	13.87	.00	-81.84	.05	129.72	36.03
17	LAYBARGE	23.13	2.57	.00	-.001	7.770	54.820	13.75	.00	-67.15	-.27	114.90	31.92
19	LAYBARGE	17.18	1.71	.00	.006	8.523	60.832	13.62	.00	-52.21	1.20	99.85	27.74
21	LAYBARGE	10.63	.66	.00	-.029	9.956	67.470	13.44	.00	-146.96	-5.20	194.49	54.03
24	STINGER	-5.62	-2.46	.00	.024	12.243	84.015	13.00	-.16	-212.17	-5.95	259.33	72.04
26	STINGER	-12.10	-4.04	.00	-.005	14.766	90.682	13.83	-.27	-99.89	-.61	146.86	40.79
28	STINGER	-18.52	-5.83	.00	-.001	16.536	97.350	13.59	-.39	-124.09	-2.19	170.89	47.47
30	STINGER	-24.88	-7.84	.00	.009	18.494	104.017	13.34	-.52	-121.47	-.01	168.07	46.69
32	STINGER	-31.16	-10.06	.00	-.040	20.319	110.684	13.06	-.67	-108.28	-8.75	155.02	43.06
34	STINGER	-37.38	-12.47	.03	-.725	22.091	117.352	13.74	-.83	-114.46	-69.05	179.83	49.95
36	SAGEBEND	-48.45	-17.09	.27	-1.379	22.446	129.352	13.16	-1.14	24.37	1.48	70.16	19.49
37	SAGEBEND	-59.58	-21.56	.53	-1.193	21.245	141.352	13.59	-1.44	32.55	5.20	78.28	21.74
38	SAGEBEND	-70.81	-25.78	.74	-.969	19.937	153.352	13.05	-1.72	33.55	5.25	78.88	21.91
39	SAGEBEND	-82.14	-29.74	.91	-.752	18.600	165.352	13.54	-1.98	34.13	5.07	79.06	21.96
40	SAGEBEND	-93.56	-33.43	1.04	-.546	17.242	177.353	13.07	-2.23	34.67	4.85	79.21	22.00
41	SAGEBEND	-105.06	-36.85	1.13	-.350	15.864	189.353	13.63	-2.45	35.17	4.65	79.36	22.05
42	SAGEBEND	-116.64	-39.99	1.18	-.164	14.466	201.353	13.22	-2.66	35.65	4.42	79.51	22.09

43	SAGEBEND	-128.30	-42.84	1.19	.011	13.050	213.353	13.86	-2.85	36.08	4.15	79.64	22.12
44	SAGEBEND	-140.02	-45.41	1.17	.173	11.617	225.354	13.53	-3.02	36.48	3.85	79.77	22.16
45	SAGEBEND	-151.80	-47.68	1.12	.322	10.170	237.354	13.24	-3.17	36.84	3.54	79.88	22.19
46	SAGEBEND	-163.64	-49.64	1.04	.458	8.709	249.354	13.99	-3.31	37.15	3.22	79.98	22.22
47	SAGEBEND	-175.52	-51.31	.93	.580	7.237	261.354	13.77	-3.42	37.42	2.92	80.07	22.24
48	SAGEBEND	-187.45	-52.67	.80	.691	5.755	273.355	13.60	-3.51	37.64	2.71	80.15	22.26
49	SAGEBEND	-199.40	-53.71	.65	.796	4.266	285.355	13.46	-3.58	37.81	2.63	80.21	22.28
50	SAGEBEND	-211.38	-54.45	.47	.900	2.771	297.356	13.37	-3.63	37.85	2.56	80.18	22.27
51	SAGEBEND	-223.37	-54.88	.27	.988	1.289	309.356	13.31	-3.65	36.53	1.29	78.76	21.88
52	SEABED	-235.36	-55.00	.07	.825	.079	321.356	13.30	-3.66	14.25	-18.17	65.30	18.14
53	SEABED	-247.36	-55.01	.00	-.008	.005	333.356	13.30	-3.66	.36	-3.16	45.42	12.62
54	SEABED	-259.36	-55.01	.00	.002	.000	345.356	13.30	-3.66	.01	-.11	42.35	11.76
55	SEABED	-271.36	-55.01	.00	.000	.000	357.356	13.30	-3.66	.00	.00	42.25	11.74
56	SEABED	-283.36	-55.01	.00	.000	.000	369.356	13.30	-3.66	.00	.00	42.25	11.74
57	SEABED	-295.36	-55.01	.00	.000	.000	381.356	13.30	-3.66	.00	.00	42.25	11.74
58	SEABED	-307.36	-55.01	.00	.000	.000	393.356	13.30	-3.66	.00	.00	42.25	11.74

OFFPIPE - OFFSHORE PIPELINE ANALYSIS SYSTEM - VERSION 2.05 AC DATE - 4/20/2020 TIME - 22:41:42 PAGE 86

PROJECT - TUGAS AKHIR

JOB NO. ANALISIS STATIS

USER ID - IDA BAGUS FUNDHARA SAKYANARY

LICENSED TO: RICKY TAMEKAL

CASE 1

STATIC PIPE COORDINATES, FORCES AND STRESSES

NODE NO.	PIPE SECTION	X	Y	Z	SUPPORT REACTION		SUPT SEPARATIONS		PIPE TENSION	BENDING MOMENTS		
		COORD (M)	COORD (M)	COORD (M)	VERT (KN)	HORIZ (KN)	VERT (M)	HORIZ (M)	(KN)	VERT (KN-M)	HORIZ (KN-M)	TOTAL (KN-M)
1	TENSIONR	77.79	6.21	.00	.55	.00	.00	.00	300.00	.00	.00	.00
3	LAYBARGE	71.49	6.17	.00	14.57	.00	.00	.00	299.92	-18.92	.00	18.92
5	LAYBARGE	65.37	6.04	.00	8.74	.00	.00	.00	299.81	-13.49	.00	13.49
7	LAYBARGE	59.91	5.84	.00	10.88	.00	.00	.00	299.61	-15.52	.00	15.52
9	LAYBARGE	53.32	5.51	.00	10.15	.00	.00	.00	299.29	-14.87	.00	14.87
11	LAYBARGE	47.32	5.11	.00	13.22	.00	.00	.00	298.88	-18.61	.00	18.61
13	LAYBARGE	38.21	4.33	.00	16.50	.00	.00	.00	298.10	-22.69	.00	22.69
15	LAYBARGE	29.27	3.35	.00	13.06	.01	.00	.00	297.17	-18.39	.01	18.39
17	LAYBARGE	23.13	2.57	.00	10.45	-.07	.00	.00	296.41	-15.09	-.06	15.09

19	LAYBARGE	17.18	1.71	.00	7.02	.27	.00	.00	295.59	-11.73	.27	11.74
21	LAYBARGE	10.63	.66	.00	20.14	-.87	.00	.00	294.45	-33.02	-1.17	33.04
24	STINGER	-5.62	-2.46	.00	26.27	-1.18	.00	.00	292.27	-47.67	-1.34	47.69
26	STINGER	-12.10	-4.04	.00	8.82	-.43	.00	.00	291.59	-22.44	-.14	22.44
28	STINGER	-18.52	-5.83	.00	14.25	-.78	.00	.00	290.52	-27.88	-.49	27.88
30	STINGER	-24.88	-7.84	.00	13.63	-.29	.00	.00	289.38	-27.29	.00	27.29
32	STINGER	-31.16	-10.06	.00	11.79	-.19	.00	.00	288.13	-24.33	-1.97	24.41
34	STINGER	-37.38	-12.47	.03	15.10	-8.82	.02	.03	286.71	-25.72	-15.52	30.03
36	SAGEBEND	-48.45	-17.09	.27	.00	.00	.00	.00	284.16	5.48	.33	5.49
37	SAGEBEND	-59.58	-21.56	.53	.00	.00	.00	.00	281.59	7.31	1.17	7.41
38	SAGEBEND	-70.81	-25.78	.74	.00	.00	.00	.00	279.17	7.54	1.18	7.63
39	SAGEBEND	-82.14	-29.74	.91	.00	.00	.00	.00	276.90	7.67	1.14	7.75
40	SAGEBEND	-93.56	-33.43	1.04	.00	.00	.00	.00	274.79	7.79	1.09	7.87
41	SAGEBEND	-105.06	-36.85	1.13	.00	.00	.00	.00	272.83	7.90	1.04	7.97
42	SAGEBEND	-116.64	-39.99	1.18	.00	.00	.00	.00	271.03	8.01	.99	8.07
43	SAGEBEND	-128.30	-42.84	1.19	.00	.00	.00	.00	269.39	8.11	.93	8.16
44	SAGEBEND	-140.02	-45.41	1.17	.00	.00	.00	.00	267.93	8.20	.86	8.24
45	SAGEBEND	-151.80	-47.68	1.12	.00	.00	.00	.00	266.63	8.28	.80	8.32
46	SAGEBEND	-163.64	-49.64	1.04	.00	.00	.00	.00	265.50	8.35	.72	8.38
47	SAGEBEND	-175.52	-51.31	.93	.00	.00	.00	.00	264.54	8.41	.66	8.43
48	SAGEBEND	-187.45	-52.67	.80	.00	.00	.00	.00	263.77	8.46	.61	8.48
49	SAGEBEND	-199.40	-53.71	.65	.00	.00	.00	.00	263.17	8.49	.59	8.52
50	SAGEBEND	-211.38	-54.45	.47	.00	.00	.00	.00	262.74	8.50	.57	8.52
51	SAGEBEND	-223.37	-54.88	.27	.01	-.02	.00	.00	262.50	8.21	.29	8.21
52	SEABED	-235.36	-55.00	.07	4.27	-4.00	.00	.00	262.43	3.20	-4.08	5.19
53	SEABED	-247.36	-55.01	.00	7.09	-1.12	.00	.00	262.42	.08	-.71	.72
54	SEABED	-259.36	-55.01	.00	6.88	.05	.00	.00	262.42	.00	-.02	.02
55	SEABED	-271.36	-55.01	.00	6.88	.00	.00	.00	262.42	.00	.00	.00
56	SEABED	-283.36	-55.01	.00	6.88	.00	.00	.00	262.42	.00	.00	.00
57	SEABED	-295.36	-55.01	.00	6.88	.00	.00	.00	262.42	.00	.00	.00
58	SEABED	-307.36	-55.01	.00	.00	.00	.00	.00	262.42	.00	.00	.00

STATIC SOLUTION SUMMARY

PIPE PROPERTIES (1)

PIPE SECTION LENGTH ..	12.00 M	ELASTIC MODULUS	207000. MPA
OUTSIDE DIAMETER	16.827 CM	CROSS SECTIONAL AREA .	278.27 CM2
WALL THICKNESS	1.270 CM	MOMENT OF INERTIA	1890.46 CM4
WEIGHT/LENGTH IN AIR .	976.987 N/M	YIELD STRESS	360.00 MPA
SUBMERGED WGT/LENG ..	572.993 N/M	STRESS INTENS FACTOR .	1.000
SPECIFIC GRAVITY	2.418	STEEL DENSITY	76982.0 N/M3
WRAP COAT THICKNESS ..	.400 CM	WRAP COAT DENSITY	12567.0 N/M3
CONCRETE THICKNESS ...	2.500 CM	CONCRETE DENSITY	29856.0 N/M3

BARGE DATA

TOTAL PIPE TENSION ...	300.00 KN	RADIUS OF CURVATURE ..	400.00 M
NUMBER OF TENSIONERS .	1	BARGE TRIM ANGLE000 DEG
NO. OF PIPE SUPPORTS .	10	PIPE ANGLE AT STERN ..	9.956 DEG
BARGE HEADING000 DEG	OFFSET FROM R.O.W.00 M

STINGER DATA

NO. OF PIPE SUPPORTS .	6	STINGER STERN DEPTH ..	-12.47 M
NO. STINGER SECTIONS .	6	PIPE ANGLE AT STERN ..	22.091 DEG
RADIUS OF CURVATURE ..	200.00 M	STINGER LENGTH	41.63 M

SAGEBEND DATA

WATER DEPTH	55.00 M	HORIZ PIPE TENSION ...	262.42 KN
TOUCHDOWN X-COORD. ...	-233.47 M	BOTTOM SLOPE ANGLE000 DEG

===== SOLUTION SUMMARY =====

NODE	PIPE	X	Y	Z	SUPPORT	REACT	TOTAL	TOTAL	PCT
NO.	SECTION	COORD	COORD	COORD	VERT	HORIZ	MOMENT	STRESS	YLD
1	TENSIONR	77.8	6.2	.0	.5	.0	.0	48.3	13.
3	LAYBARGE	71.5	6.2	.0	14.6	.0	18.9	132.5	37.
5	LAYBARGE	65.4	6.0	.0	8.7	.0	13.5	108.3	30.
7	LAYBARGE	59.9	5.8	.0	10.9	.0	15.5	117.3	33.
9	LAYBARGE	53.3	5.5	.0	10.1	.0	14.9	114.4	32.
11	LAYBARGE	47.3	5.1	.0	13.2	.0	18.6	131.0	36.
13	LAYBARGE	38.2	4.3	.0	16.5	.0	22.7	149.0	41.
15	LAYBARGE	29.3	3.4	.0	13.1	.0	18.4	129.7	36.
17	LAYBARGE	23.1	2.6	.0	10.5	-.1	15.1	114.9	32.
19	LAYBARGE	17.2	1.7	.0	7.0	.3	11.7	99.8	28.
21	LAYBARGE	10.6	.7	.0	20.1	-.9	33.0	194.5	54.
24	STINGER	-5.6	-2.5	.0	26.3	-1.2	47.7	259.3	72.
26	STINGER	-12.1	-4.0	.0	8.8	-.4	22.4	146.9	41.
28	STINGER	-18.5	-5.8	.0	14.3	-.8	27.9	170.9	47.
30	STINGER	-24.9	-7.8	.0	13.6	-.3	27.3	168.1	47.
32	STINGER	-31.2	-10.1	.0	11.8	-.2	24.4	155.0	43.

OFFPIPE - OFFSHORE PIPELINE ANALYSIS SYSTEM - VERSION 2.05 AC PAGE 88

JOB NO. - TUGAS AKHIR LICENSED TO: RICKY TAMEKAL

USER ID - IDA BAGUS FUNDHARA S DATE - 4/20/2020 TIME - 22:41:42 CASE 1

===== S T A T I C S O L U T I O N S U M M A R Y =====

34	STINGER	-37.4	-12.5	.0	15.1	-8.8	30.0	179.8	50.
49	SAGBEND	-199.4	-53.7	.6	.0	.0	8.5	80.2	22.
52	SEABED	-235.4	-55.0	.1	4.3	-4.0	5.2	65.3	18.

STATIC PIPE COORDINATES, FORCES AND STRESSES

NODE NO.	PIPE SECTION	X	Y	Z	HORIZ	VERT	PIPE	TENSILE	HOOP	BENDING STRESSES		TOTAL	PERCNT
		COORD (M)	COORD (M)	COORD (M)	ANGLE (DEG)	ANGLE (DEG)	LENGIH (M)	STRESS (MPA)	STRESS (MPA)	VERT (MPA)	HORIZ (MPA)	STRESS (MPA)	YIELD (PCT)
1	TENSIONR	77.79	6.21	.00	.000	.255	.000	13.34	.00	.00	.00	48.34	13.43
3	LAYBARGE	71.49	6.17	.00	.000	.713	6.300	13.33	.00	-84.23	-.01	132.55	36.82
5	LAYBARGE	65.37	6.04	.00	.000	1.664	12.416	13.31	.00	-60.03	.00	108.34	30.10
7	LAYBARGE	59.91	5.84	.00	.000	2.476	17.883	13.28	.00	-69.05	.00	117.33	32.59
9	LAYBARGE	53.32	5.51	.00	.000	3.357	24.482	13.22	.00	-66.17	.00	114.40	31.78
11	LAYBARGE	47.32	5.11	.00	.000	4.344	30.493	13.16	.00	-82.84	.00	131.00	36.39
13	LAYBARGE	38.21	4.33	.00	.000	5.557	39.635	13.03	.00	-100.98	-.01	149.01	41.39
15	LAYBARGE	29.27	3.35	.00	.000	6.775	48.632	13.88	.00	-81.86	.05	129.74	36.04
17	LAYBARGE	23.13	2.57	.00	-.001	7.770	54.820	13.76	.00	-67.08	-.27	114.84	31.90
19	LAYBARGE	17.18	1.71	.00	.006	8.524	60.832	13.63	.00	-52.52	1.20	100.16	27.82
21	LAYBARGE	10.63	.66	.00	-.028	9.949	67.470	13.44	.00	-145.65	-5.18	193.19	53.66
24	STINGER	-5.62	-2.43	.00	.023	11.748	84.008	13.02	-.16	-165.02	-6.01	319.68	85.47
26	STINGER	-12.12	-3.91	.00	-.002	13.567	90.675	13.86	-.26	-65.15	-.13	112.14	31.15
28	STINGER	-18.58	-5.53	.00	-.013	14.716	97.342	13.65	-.37	-86.74	-4.40	133.68	37.13
30	STINGER	-25.01	-7.30	.00	.065	16.031	104.009	13.42	-.49	-84.39	9.95	131.64	36.57
32	STINGER	-31.40	-9.20	-.01	.119	16.978	110.676	13.18	-.61	-43.71	-7.17	90.79	25.22
34	STINGER	-37.74	-11.26	.00	-.636	19.992	117.343	13.80	-.75	-323.47	-81.18	379.68	105.47
36	SAGEBEND	-48.84	-15.81	.25	-1.423	22.666	129.343	13.33	-1.05	12.79	.87	58.68	16.30
37	SAGEBEND	-59.95	-20.34	.51	-1.243	21.599	141.343	13.74	-1.35	31.76	5.21	77.61	21.56
38	SAGEBEND	-71.16	-24.63	.73	-1.017	20.303	153.343	13.19	-1.64	33.36	5.29	78.80	21.89
39	SAGEBEND	-82.46	-28.67	.91	-.797	18.973	165.343	13.68	-1.91	33.98	5.13	79.01	21.95
40	SAGEBEND	-93.85	-32.44	1.04	-.588	17.621	177.343	13.19	-2.16	34.53	4.91	79.17	21.99
41	SAGEBEND	-105.33	-35.93	1.14	-.389	16.248	189.343	13.74	-2.39	35.04	4.71	79.32	22.03
42	SAGEBEND	-116.89	-39.15	1.20	-.200	14.855	201.343	13.33	-2.61	35.52	4.49	79.47	22.07

43	SAGEBEND	-128.52	-42.08	1.22	-.022	13.444	213.344	13.95	-2.80	35.97	4.23	79.61	22.11
44	SAGEBEND	-140.23	-44.73	1.21	.145	12.016	225.344	13.61	-2.98	36.38	3.94	79.74	22.15
45	SAGEBEND	-151.99	-47.08	1.17	.297	10.572	237.344	13.31	-3.13	36.75	3.63	79.85	22.18
46	SAGEBEND	-163.82	-49.13	1.09	.437	9.115	249.344	13.05	-3.27	37.07	3.31	79.96	22.21
47	SAGEBEND	-175.69	-50.88	.99	.562	7.646	261.345	13.82	-3.39	37.35	2.99	80.05	22.23
48	SAGEBEND	-187.60	-52.32	.86	.676	6.167	273.345	13.64	-3.48	37.59	2.74	80.12	22.26
49	SAGEBEND	-199.55	-53.45	.70	.782	4.679	285.345	13.49	-3.56	37.77	2.63	80.19	22.28
50	SAGEBEND	-211.52	-54.28	.53	.886	3.185	297.346	13.39	-3.61	37.87	2.60	80.22	22.28
51	SAGEBEND	-223.51	-54.79	.33	.984	1.694	309.347	13.32	-3.65	37.38	2.10	79.65	22.12
52	SAGEBEND	-235.50	-54.99	.12	.982	.314	321.347	13.30	-3.66	27.63	-6.50	70.59	19.61
53	SEABED	-247.50	-55.01	.00	.090	.003	333.347	13.30	-3.66	.52	-15.80	58.02	16.12
54	SEABED	-259.50	-55.01	.00	.005	.000	345.347	13.30	-3.66	.01	-.40	42.64	11.84
55	SEABED	-271.50	-55.01	.00	.000	.000	357.347	13.30	-3.66	.00	-.01	42.25	11.74
56	SEABED	-283.50	-55.01	.00	.000	.000	369.347	13.30	-3.66	.00	.00	42.25	11.74
57	SEABED	-295.50	-55.01	.00	.000	.000	381.347	13.30	-3.66	.00	.00	42.25	11.74
58	SEABED	-307.50	-55.01	.00	.000	.000	393.347	13.30	-3.66	.00	.00	42.25	11.74
59	SEABED	-319.50	-55.01	.00	.000	.000	405.347	13.30	-3.66	.00	.00	42.25	11.74

STATIC PIPE COORDINATES, FORCES AND STRESSES

NODE NO.	PIPE SECTION	X	Y	Z	SUPPORT REACTION		SUPT SEPARATIONS		PIPE TENSION	BENDING MOMENTS		
		COORD (M)	COORD (M)	COORD (M)	VERT (KN)	HORIZ (KN)	VERT (M)	HORIZ (M)	(KN)	VERT (KN-M)	HORIZ (KN-M)	TOTAL (KN-M)
1	TENSIONR	77.79	6.21	.00	.55	.01	.00	.00	300.05	.00	.00	.00
3	LAYBARGE	71.49	6.17	.00	14.57	.00	.00	.00	299.97	-18.92	.00	18.92
5	LAYBARGE	65.37	6.04	.00	8.74	.00	.00	.00	299.86	-13.49	.00	13.49
7	LAYBARGE	59.91	5.84	.00	10.88	.00	.00	.00	299.66	-15.52	.00	15.52
9	LAYBARGE	53.32	5.51	.00	10.15	.00	.00	.00	299.34	-14.87	.00	14.87
11	LAYBARGE	47.32	5.11	.00	13.22	.00	.00	.00	298.93	-18.61	.00	18.61
13	LAYBARGE	38.21	4.33	.00	16.50	.00	.00	.00	298.14	-22.69	.00	22.69
15	LAYBARGE	29.27	3.35	.00	13.07	.01	.00	.00	297.21	-18.39	.01	18.39
17	LAYBARGE	23.13	2.57	.00	10.43	-.07	.00	.00	296.46	-15.07	-.06	15.07
19	LAYBARGE	17.18	1.71	.00	7.09	.27	.00	.00	295.64	-11.80	.27	11.80
21	LAYBARGE	10.63	.66	.00	20.22	-.87	.00	.00	294.50	-32.73	-1.16	32.75
24	STINGER	-5.62	-2.43	.00	21.31	-1.20	.00	.00	292.42	-37.08	-1.35	37.10
26	STINGER	-12.12	-3.91	.00	6.11	-.32	.00	.00	291.72	-14.64	-.03	14.64
28	STINGER	-18.58	-5.53	.00	10.96	-1.29	.00	.00	290.77	-19.49	-.99	19.51
30	STINGER	-25.01	-7.30	.00	11.02	1.00	.00	.00	289.76	-18.96	2.24	19.09
32	STINGER	-31.40	-9.20	-.01	.00	.00	.01	-.01	288.70	-9.82	-1.61	9.95
34	STINGER	-37.74	-11.26	.00	42.15	-10.23	.00	.00	286.83	-72.68	-18.24	74.93
36	SAGEBEND	-48.84	-15.81	.25	.00	.00	.00	.00	284.88	2.87	.19	2.88
37	SAGEBEND	-59.95	-20.34	.51	.00	.00	.00	.00	282.28	7.13	1.17	7.23
38	SAGEBEND	-71.16	-24.63	.73	.00	.00	.00	.00	279.82	7.49	1.19	7.59
39	SAGEBEND	-82.46	-28.67	.91	.00	.00	.00	.00	277.51	7.63	1.15	7.72
40	SAGEBEND	-93.85	-32.44	1.04	.00	.00	.00	.00	275.35	7.76	1.10	7.84
41	SAGEBEND	-105.33	-35.93	1.14	.00	.00	.00	.00	273.34	7.87	1.06	7.94
42	SAGEBEND	-116.89	-39.15	1.20	.00	.00	.00	.00	271.50	7.98	1.01	8.04

43	SAGEBND	-128.52	-42.08	1.22	.00	.00	.00	.00	269.82	8.08	.95	8.14
44	SAGEBND	-140.23	-44.73	1.21	.00	.00	.00	.00	268.30	8.17	.89	8.22
45	SAGEBND	-151.99	-47.08	1.17	.00	.00	.00	.00	266.96	8.26	.82	8.30
46	SAGEBND	-163.82	-49.13	1.09	.00	.00	.00	.00	265.78	8.33	.74	8.36
47	SAGEBND	-175.69	-50.88	.99	.00	.00	.00	.00	264.78	8.39	.67	8.42
48	SAGEBND	-187.60	-52.32	.86	.00	.00	.00	.00	263.95	8.45	.62	8.47
49	SAGEBND	-199.55	-53.45	.70	.00	.00	.00	.00	263.30	8.49	.59	8.51
50	SAGEBND	-211.52	-54.28	.53	.00	.00	.00	.00	262.83	8.51	.58	8.53
51	SAGEBND	-223.51	-54.79	.33	.00	.00	.00	.00	262.54	8.40	.47	8.41
52	SAGEBND	-235.50	-54.99	.12	2.24	-2.01	.00	.00	262.42	6.21	-1.46	6.38
53	SEABED	-247.50	-55.01	.00	7.21	-3.24	.00	.00	262.42	.12	-3.55	3.55
54	SEABED	-259.50	-55.01	.00	6.88	.23	.00	.00	262.42	.00	-.09	.09
55	SEABED	-271.50	-55.01	.00	6.88	.01	.00	.00	262.42	.00	.00	.00
56	SEABED	-283.50	-55.01	.00	6.88	.00	.00	.00	262.42	.00	.00	.00
57	SEABED	-295.50	-55.01	.00	6.88	.00	.00	.00	262.42	.00	.00	.00
58	SEABED	-307.50	-55.01	.00	6.88	.00	.00	.00	262.42	.00	.00	.00
59	SEABED	-319.50	-55.01	.00	.00	.00	.00	.00	262.42	.00	.00	.00

STATIC SOLUTION SUMMARY

PIPE PROPERTIES (1)

PIPE SECTION LENGTH ..	12.00 M	ELASTIC MODULUS	207000. MPA
OUTSIDE DIAMETER	16.827 CM	CROSS SECTIONAL AREA .	278.27 CM2
WALL THICKNESS	1.270 CM	MOMENT OF INERTIA	1890.46 CM4
WEIGHT/LENGTH IN AIR .	976.987 N/M	YIELD STRESS	360.00 MPA
SUBMERGED WGH/LENG ..	572.993 N/M	STRESS INIENS FACTOR .	1.000
SPECIFIC GRAVITY	2.418	STEEL DENSITY	76982.0 N/M3
WRAP COAT THICKNESS ..	.400 CM	WRAP COAT DENSITY	12567.0 N/M3
CONCRETE THICKNESS ...	2.500 CM	CONCRETE DENSITY	29856.0 N/M3

BARGE DATA

TOTAL PIPE TENSION ...	300.05 KN	RADIUS OF CURVATURE ..	400.00 M
NUMBER OF TENSIONERS .	1	BARGE TRIM ANGLE000 DEG
NO. OF PIPE SUPPORTS .	10	PIPE ANGLE AT STERN ..	9.949 DEG
BARGE HEADING000 DEG	OFFSET FROM R.O.W.00 M

STINGER DATA

NO. OF PIPE SUPPORTS .	6	STINGER STERN DEPTH ..	-11.26 M
NO. STINGER SECTIONS .	6	PIPE ANGLE AT STERN ..	19.992 DEG
RADIUS OF CURVATURE ..	300.00 M	STINGER LENGIH	41.61 M

SAGEEND DATA

WATER DEPTH	55.00 M	HORIZ PIPE TENSION ...	262.42 KN
TOUCHDOWN X-COORD. ...	-237.05 M	BOITOM SLOPE ANGLE000 DEG

===== SOLUTION SUMMARY =====

NODE	PIPE	X	Y	Z	SUPPORT	REACT	TOTAL	TOTAL	PCT
NO.	SECTION	COORD	COORD	COORD	VERT	HORIZ	MOMENT	STRESS	YLD
1	TENSIONR	77.8	6.2	.0	.5	.0	.0	48.3	13.
3	LAYBARGE	71.5	6.2	.0	14.6	.0	18.9	132.6	37.
5	LAYBARGE	65.4	6.0	.0	8.7	.0	13.5	108.3	30.
7	LAYBARGE	59.9	5.8	.0	10.9	.0	15.5	117.3	33.
9	LAYBARGE	53.3	5.5	.0	10.1	.0	14.9	114.4	32.
11	LAYBARGE	47.3	5.1	.0	13.2	.0	18.6	131.0	36.
13	LAYBARGE	38.2	4.3	.0	16.5	.0	22.7	149.0	41.
15	LAYBARGE	29.3	3.4	.0	13.1	.0	18.4	129.7	36.
17	LAYBARGE	23.1	2.6	.0	10.4	-.1	15.1	114.8	32.
19	LAYBARGE	17.2	1.7	.0	7.1	.3	11.8	100.2	28.
21	LAYBARGE	10.6	.7	.0	20.2	-.9	32.7	193.2	54.
24	STINGER	-5.6	-2.4	.0	21.3	-1.2	37.1	212.2	59.
26	STINGER	-12.1	-3.9	.0	6.1	-.3	14.6	112.1	31.
28	STINGER	-18.6	-5.5	.0	11.0	-1.3	19.5	133.7	37.
30	STINGER	-25.0	-7.3	.0	11.0	1.0	19.1	131.6	37.
32	STINGER	-31.4	-9.2	.0	.0	.0	10.0	90.8	25.

OFFPIPE - OFFSHORE PIPELINE ANALYSIS SYSTEM - VERSION 2.05 AC PAGE 88

JOB NO. - TUGAS AKHIR LICENSED TO: RICKY TAMEKAL

USER ID - IDA BAGUS FUNDHARA S DATE - 4/20/2020 TIME - 22:41:42 CASE 2

===== S T A T I C S O L U T I O N S U M M A R Y =====

34	STINGER	-37.7	-11.3	.0	42.1	-10.2	74.9	379.7	105.
50	SAGBEND	-211.5	-54.3	.5	.0	.0	8.5	80.2	22.
53	SEABED	-247.5	-55.0	.0	7.2	-3.2	3.6	58.0	16.

S T A T I C P I P E C O O R D I N A T E S , F O R C E S A N D S T R E S S E S

NODE NO.	PIPE SECTION	X	Y	Z	HORIZ	VERT	PIPE	TENSILE	HOOP	BENDING STRESSES		TOTAL	PERCNT
		COORD (M)	COORD (M)	COORD (M)	ANGLE (DEG)	ANGLE (DEG)	LENGTH (M)	STRESS (MPA)	STRESS (MPA)	VERT (MPA)	HORIZ (MPA)	STRESS (MPA)	YIELD (PCT)
1	TENSIONR	77.79	6.21	.00	.000	.255	.000	13.34	.00	.00	.00	48.34	13.43
3	LAYBARGE	71.49	6.17	.00	.000	.713	6.300	13.33	.00	-84.23	-.01	132.56	36.82
5	LAYBARGE	65.37	6.04	.00	.000	1.664	12.416	13.31	.00	-60.03	.00	108.35	30.10
7	LAYBARGE	59.91	5.84	.00	.000	2.476	17.883	13.28	.00	-69.05	.00	117.33	32.59
9	LAYBARGE	53.32	5.51	.00	.000	3.357	24.482	13.23	.00	-66.18	.00	114.40	31.78
11	LAYBARGE	47.32	5.11	.00	.000	4.344	30.493	13.16	.00	-82.84	.00	131.00	36.39
13	LAYBARGE	38.21	4.33	.00	.000	5.557	39.635	13.03	.00	-100.98	-.01	149.02	41.39
15	LAYBARGE	29.27	3.35	.00	.000	6.775	48.632	13.89	.00	-81.87	.05	129.75	36.04
17	LAYBARGE	23.13	2.57	.00	-.001	7.770	54.820	13.76	.00	-67.05	-.27	114.81	31.89
19	LAYBARGE	17.18	1.71	.00	.006	8.525	60.832	13.63	.00	-52.68	1.20	100.32	27.87
21	LAYBARGE	10.63	.66	.00	-.028	9.946	67.470	13.45	.00	-144.98	-5.17	192.52	53.48
24	STINGER	-5.62	-2.41	.00	.023	11.503	84.004	13.03	-.16	-141.71	-6.01	180.39	52.49
26	STINGER	-12.13	-3.85	.00	-.002	12.961	90.671	13.87	-.26	-46.40	-.12	93.39	25.94
28	STINGER	-18.62	-5.39	.00	-.013	13.840	97.338	13.67	-.36	-74.28	-4.44	121.26	33.68
30	STINGER	-25.08	-7.03	.00	.065	14.648	104.005	13.46	-.47	-37.97	10.08	85.98	23.88
32	STINGER	-31.52	-8.75	-.01	.120	15.254	110.672	13.24	-.58	-50.65	-7.27	97.70	27.14
34	STINGER	-37.91	-10.65	.00	-.640	19.107	117.339	13.82	-.71	-414.05	-82.65	468.39	130.11
36	SAGEBEND	-49.02	-15.17	.25	-1.439	22.784	129.339	13.41	-1.01	7.78	.82	53.74	14.93
37	SAGEBEND	-60.11	-19.73	.51	-1.258	21.775	141.339	13.82	-1.31	31.40	5.23	77.32	21.48
38	SAGEBEND	-71.30	-24.06	.74	-1.031	20.485	153.339	13.26	-1.60	33.26	5.31	78.76	21.88
39	SAGEBEND	-82.59	-28.13	.92	-.810	19.159	165.339	13.74	-1.87	33.91	5.15	78.99	21.94
40	SAGEBEND	-93.97	-31.93	1.06	-.599	17.809	177.339	13.25	-2.13	34.46	4.94	79.15	21.98
41	SAGEBEND	-105.44	-35.47	1.16	-.399	16.439	189.339	13.80	-2.36	34.97	4.74	79.30	22.03
42	SAGEBEND	-116.99	-38.72	1.22	-.208	15.049	201.339	13.38	-2.58	35.46	4.52	79.45	22.07
43	SAGEBEND	-128.61	-41.69	1.24	-.029	13.640	213.339	13.00	-2.78	35.91	4.27	79.59	22.11

44	SAGEBEND	-140.31	-44.38	1.23	.139	12.214	225.339	13.66	-2.95	36.33	3.99	79.72	22.14
45	SAGEBEND	-152.07	-46.77	1.19	.294	10.772	237.340	13.35	-3.11	36.70	3.67	79.84	22.18
46	SAGEBEND	-163.88	-48.86	1.11	.435	9.317	249.340	13.08	-3.25	37.03	3.35	79.94	22.21
47	SAGEBEND	-175.75	-50.66	1.01	.563	7.849	261.340	13.85	-3.37	37.32	3.03	80.03	22.23
48	SAGEBEND	-187.66	-52.14	.88	.678	6.371	273.340	13.66	-3.47	37.56	2.77	80.11	22.25
49	SAGEBEND	-199.60	-53.32	.73	.784	4.884	285.341	13.51	-3.55	37.75	2.64	80.19	22.27
50	SAGEBEND	-211.56	-54.18	.55	.888	3.391	297.342	13.40	-3.61	37.87	2.61	80.22	22.28
51	SAGEBEND	-223.55	-54.74	.35	.987	1.898	309.342	13.33	-3.64	37.58	2.18	79.85	22.18
52	SAGEBEND	-235.55	-54.98	.14	1.001	.477	321.343	13.30	-3.66	31.12	-5.11	73.73	20.48
53	SEABED	-247.55	-55.01	.00	.158	-.003	333.343	13.30	-3.66	.50	-20.63	62.84	17.46
54	SEABED	-259.55	-55.01	.00	.005	.000	345.343	13.30	-3.66	.02	-.47	42.72	11.87
55	SEABED	-271.55	-55.01	.00	.000	.000	357.343	13.30	-3.66	.00	-.01	42.26	11.74
56	SEABED	-283.55	-55.01	.00	.000	.000	369.343	13.30	-3.66	.00	.00	42.25	11.74
57	SEABED	-295.55	-55.01	.00	.000	.000	381.343	13.30	-3.66	.00	.00	42.25	11.74
58	SEABED	-307.55	-55.01	.00	.000	.000	393.343	13.30	-3.66	.00	.00	42.25	11.74
59	SEABED	-319.55	-55.01	.00	.000	.000	405.343	13.30	-3.66	.00	.00	42.25	11.74

STATIC PIPE COORDINATES, FORCES AND STRESSES

NODE NO.	PIPE SECTION	X	Y	Z	SUPPORT REACTION		SUPT SEPARATIONS		PIPE TENSION (KN)	BENDING MOMENTS		
		COORD (M)	COORD (M)	COORD (M)	VERT (KN)	HORIZ (KN)	VERT (M)	HORIZ (M)		VERT (KN-M)	HORIZ (KN-M)	TOTAL (KN-M)
1	TENSIONR	77.79	6.21	.00	.55	.01	.00	.00	300.07	.00	.00	.00
3	LAYBARGE	71.49	6.17	.00	14.58	.00	.00	.00	299.98	-18.92	.00	18.92
5	LAYBARGE	65.37	6.04	.00	8.74	.00	.00	.00	299.88	-13.49	.00	13.49
7	LAYBARGE	59.91	5.84	.00	10.88	.00	.00	.00	299.68	-15.52	.00	15.52
9	LAYBARGE	53.32	5.51	.00	10.15	.00	.00	.00	299.35	-14.87	.00	14.87
11	LAYBARGE	47.32	5.11	.00	13.22	.00	.00	.00	298.95	-18.61	.00	18.61
13	LAYBARGE	38.21	4.33	.00	16.50	.00	.00	.00	298.16	-22.69	.00	22.69
15	LAYBARGE	29.27	3.35	.00	13.07	.01	.00	.00	297.23	-18.39	.01	18.39
17	LAYBARGE	23.13	2.57	.00	10.43	-.07	.00	.00	296.48	-15.06	-.06	15.07
19	LAYBARGE	17.18	1.71	.00	7.12	.27	.00	.00	295.65	-11.84	.27	11.84
21	LAYBARGE	10.63	.66	.00	20.26	-.87	.00	.00	294.52	-32.58	-1.16	32.60
24	STINGER	-5.62	-2.41	.00	18.88	-1.20	.00	.00	292.49	-31.84	-1.35	31.87
26	STINGER	-12.13	-3.85	.00	4.44	-.32	.00	.00	291.78	-10.42	-.03	10.42
28	STINGER	-18.62	-5.39	.00	10.72	-1.29	.00	.00	290.88	-16.69	-1.00	16.72
30	STINGER	-25.08	-7.03	.00	5.19	1.02	.00	.00	289.96	-8.53	2.26	8.83
32	STINGER	-31.52	-8.75	-.01	.00	.00	.04	-.01	288.97	-11.38	-1.63	11.50
34	STINGER	-37.91	-10.65	.00	53.14	-10.37	.00	.00	286.76	-93.03	-18.57	94.87
36	SAGEBEND	-49.02	-15.17	.25	.00	.00	.00	.00	285.23	1.75	.18	1.76
37	SAGEBEND	-60.11	-19.73	.51	.00	.00	.00	.00	282.61	7.06	1.18	7.15
38	SAGEBEND	-71.30	-24.06	.74	.00	.00	.00	.00	280.13	7.47	1.19	7.57
39	SAGEBEND	-82.59	-28.13	.92	.00	.00	.00	.00	277.80	7.62	1.16	7.71
40	SAGEBEND	-93.97	-31.93	1.06	.00	.00	.00	.00	275.62	7.74	1.11	7.82
41	SAGEBEND	-105.44	-35.47	1.16	.00	.00	.00	.00	273.59	7.86	1.06	7.93
42	SAGEBEND	-116.99	-38.72	1.22	.00	.00	.00	.00	271.73	7.97	1.02	8.03

43	SAGEBEND	-128.61	-41.69	1.24	.00	.00	.00	.00	270.02	8.07	.96	8.13
44	SAGEBEND	-140.31	-44.38	1.23	.00	.00	.00	.00	268.48	8.16	.90	8.21
45	SAGEBEND	-152.07	-46.77	1.19	.00	.00	.00	.00	267.11	8.25	.82	8.29
46	SAGEBEND	-163.88	-48.86	1.11	.00	.00	.00	.00	265.91	8.32	.75	8.35
47	SAGEBEND	-175.75	-50.66	1.01	.00	.00	.00	.00	264.89	8.39	.68	8.41
48	SAGEBEND	-187.66	-52.14	.88	.00	.00	.00	.00	264.04	8.44	.62	8.46
49	SAGEBEND	-199.60	-53.32	.73	.00	.00	.00	.00	263.36	8.48	.59	8.50
50	SAGEBEND	-211.56	-54.18	.55	.00	.00	.00	.00	262.87	8.51	.59	8.53
51	SAGEBEND	-223.55	-54.74	.35	.00	.00	.00	.00	262.55	8.44	.49	8.46
52	SAGEBEND	-235.55	-54.98	.14	1.41	-1.52	.00	.00	262.41	6.99	-1.15	7.09
53	SEABED	-247.55	-55.01	.00	7.10	-3.81	.00	.00	262.42	.11	-4.64	4.64
54	SEABED	-259.55	-55.01	.00	6.89	.30	.00	.00	262.42	.00	-.11	.11
55	SEABED	-271.55	-55.01	.00	6.88	.01	.00	.00	262.42	.00	.00	.00
56	SEABED	-283.55	-55.01	.00	6.88	.00	.00	.00	262.42	.00	.00	.00
57	SEABED	-295.55	-55.01	.00	6.88	.00	.00	.00	262.42	.00	.00	.00
58	SEABED	-307.55	-55.01	.00	6.88	.00	.00	.00	262.42	.00	.00	.00
59	SEABED	-319.55	-55.01	.00	.00	.00	.00	.00	262.42	.00	.00	.00

STATIC SOLUTION SUMMARY

PIPE PROPERTIES (1)

PIPE SECTION LENGTH ..	12.00 M	ELASTIC MODULUS	207000. MPA
OUTSIDE DIAMETER	16.827 CM	CROSS SECTIONAL AREA .	278.27 CM2
WALL THICKNESS	1.270 CM	MOMENT OF INERTIA	1890.46 CM4
WEIGHT/LENGTH IN AIR .	976.987 N/M	YIELD STRESS	360.00 MPA
SUBMERGED WGT/LENG ..	572.993 N/M	STRESS INIENS FACTOR .	1.000
SPECIFIC GRAVITY	2.418	STEEL DENSITY	76982.0 N/M3
WRAP COAT THICKNESS ..	.400 CM	WRAP COAT DENSITY	12567.0 N/M3
CONCRETE THICKNESS ...	2.500 CM	CONCRETE DENSITY	29856.0 N/M3

BARGE DATA

TOTAL PIPE TENSION ...	300.07 KN	RADIUS OF CURVATURE ..	400.00 M
NUMBER OF TENSIONERS .	1	BARGE TRIM ANGLE000 DEG
NO. OF PIPE SUPPORTS .	10	PIPE ANGLE AT STERN ..	9.946 DEG
BARGE HEADING000 DEG	OFFSET FROM R.O.W.00 M

STINGER DATA

NO. OF PIPE SUPPORTS .	6	STINGER STERN DEPTH ..	-10.65 M
NO. STINGER SECTIONS .	6	PIPE ANGLE AT STERN ..	19.107 DEG
RADIUS OF CURVATURE ..	400.00 M	STINGER LENGH	41.60 M

SAGEBEND DATA

WATER DEPTH	55.00 M	HORIZ PIPE TENSION ...	262.42 KN
TOUCHDOWN X-COORD. ...	-238.67 M	BOTTOM SLOPE ANGLE000 DEG

===== SOLUTION SUMMARY =====

NODE	PIPE	X	Y	Z	SUPPORT	REACT	TOTAL	TOTAL	PCT
NO.	SECTION	COORD	COORD	COORD	VERT	HORIZ	MOMENT	STRESS	YLD
1	TENSIONR	77.8	6.2	.0	.5	.0	.0	48.3	13.
3	LAYBARGE	71.5	6.2	.0	14.6	.0	18.9	132.6	37.
5	LAYBARGE	65.4	6.0	.0	8.7	.0	13.5	108.3	30.
7	LAYBARGE	59.9	5.8	.0	10.9	.0	15.5	117.3	33.
9	LAYBARGE	53.3	5.5	.0	10.1	.0	14.9	114.4	32.
11	LAYBARGE	47.3	5.1	.0	13.2	.0	18.6	131.0	36.
13	LAYBARGE	38.2	4.3	.0	16.5	.0	22.7	149.0	41.
15	LAYBARGE	29.3	3.4	.0	13.1	.0	18.4	129.8	36.
17	LAYBARGE	23.1	2.6	.0	10.4	-.1	15.1	114.8	32.
19	LAYBARGE	17.2	1.7	.0	7.1	.3	11.8	100.3	28.
21	LAYBARGE	10.6	.7	.0	20.3	-.9	32.6	192.5	53.
24	STINGER	-5.6	-2.4	.0	18.9	-1.2	31.9	188.9	52.
26	STINGER	-12.1	-3.8	.0	4.4	-.3	10.4	93.4	26.
28	STINGER	-18.6	-5.4	.0	10.7	-1.3	16.7	121.3	34.
30	STINGER	-25.1	-7.0	.0	5.2	1.0	8.8	86.0	24.
32	STINGER	-31.5	-8.8	.0	.0	.0	11.5	97.7	27.

OFFPIPE - OFFSHORE PIPELINE ANALYSIS SYSTEM - VERSION 2.05 AC PAGE 88

JOB NO. - TUGAS AKHIR LICENSED TO: RICKY TAMEKAL

USER ID - IDA BAGUS FUNDHARA S DATE - 4/20/2020 TIME - 22:41:42 CASE 3

===== S T A T I C S O L U T I O N S U M M A R Y =====

34	STINGER	-37.9	-10.6	.0	53.1	-10.4	94.9	468.4	130.
50	SAGBEND	-211.6	-54.2	.6	.0	.0	8.5	80.2	22.
53	SEABED	-247.5	-55.0	.0	7.1	-3.8	4.6	62.8	17.

STATIC PIPE COORDINATES, FORCES AND STRESSES

NODE NO.	PIPE SECTION	X	Y	Z	HORIZ	VERT	PIPE	TENSILE	HOOP	BENDING STRESSES		TOTAL	PERCNT
		COORD (M)	COORD (M)	COORD (M)	ANGLE (DEG)	ANGLE (DEG)	LENGTH (M)	STRESS (MPA)	STRESS (MPA)	VERT (MPA)	HORIZ (MPA)	STRESS (MPA)	YIELD (PCT)
1	TENSIONR	77.79	6.21	.00	.000	.440	.000	13.39	.00	.00	.00	56.39	15.66
3	LAYBARGE	71.49	6.13	.00	.000	1.445	6.301	13.36	.00	-154.41	-.01	210.76	58.54
5	LAYBARGE	65.37	5.87	.00	.000	3.334	12.421	13.33	.00	-112.67	.01	168.99	46.94
7	LAYBARGE	59.91	5.48	.00	.000	4.943	17.899	13.26	.00	-127.54	.00	183.80	51.06
9	LAYBARGE	53.32	4.80	.00	.000	6.743	24.524	13.16	.00	-123.13	.00	179.29	49.80
11	LAYBARGE	47.32	4.00	.00	.000	8.674	30.576	13.02	.00	-149.84	.00	205.86	57.18
13	LAYBARGE	38.21	2.41	.00	.000	11.175	39.821	13.76	.00	-179.46	.02	235.22	65.34
15	LAYBARGE	29.27	.43	.00	-.001	13.674	48.983	13.46	.00	-148.11	-.11	203.57	56.55
17	LAYBARGE	23.13	-1.18	.00	-.010	15.657	55.329	13.25	-.08	-117.61	-3.20	172.94	48.04
19	LAYBARGE	17.18	-2.95	.00	.043	17.346	61.537	13.02	-.20	-109.98	6.69	165.30	45.92
21	LAYBARGE	10.63	-5.12	.00	-.218	19.729	68.445	13.72	-.34	-191.71	-40.08	250.74	69.65
24	STINGER	-1.87	-9.92	.12	-.962	21.514	81.826	13.13	-.66	-65.21	-45.80	134.15	37.26
26	STINGER	-8.05	-12.39	.26	-1.364	21.794	88.493	13.82	-.83	14.10	-2.41	68.54	19.04
28	STINGER	-14.22	-14.83	.40	-1.324	21.320	95.122	13.51	-.99	25.72	3.79	80.00	22.22
30	STINGER	-20.38	-17.20	.54	-1.223	20.735	101.724	13.20	-1.15	27.61	4.63	81.78	22.72
32	STINGER	-26.52	-19.49	.67	-1.115	20.134	108.278	13.91	-1.30	28.08	4.66	82.03	22.79
34	STINGER	-32.62	-21.69	.78	-1.010	19.532	114.765	13.63	-1.44	28.33	4.58	82.05	22.79
36	SAGEBEND	-44.35	-25.72	.97	-.814	18.367	127.165	13.11	-1.71	28.75	4.47	82.07	22.80
37	SAGEBEND	-55.77	-29.38	1.11	-.631	17.225	139.168	13.64	-1.96	29.13	4.31	82.08	22.80
38	SAGEBEND	-67.27	-32.82	1.22	-.457	16.068	151.171	13.20	-2.19	29.48	4.14	82.09	22.80
39	SAGEBEND	-78.84	-36.03	1.29	-.290	14.897	163.174	13.79	-2.40	29.82	3.98	82.10	22.81
40	SAGEBEND	-90.47	-38.99	1.34	-.131	13.713	175.175	13.41	-2.60	30.14	3.80	82.12	22.81
41	SAGEBEND	-102.16	-41.72	1.35	.020	12.517	187.177	13.06	-2.78	30.44	3.61	82.13	22.81
42	SAGEBEND	-113.90	-44.19	1.33	.161	11.310	199.178	13.74	-2.94	30.71	3.38	82.15	22.82
43	SAGEBEND	-125.69	-46.42	1.28	.292	10.092	211.179	13.45	-3.09	30.96	3.13	82.16	22.82

44	SAGEBEND	-137.53	-48.40	1.21	.413	8.866	223.179	13.20	-3.22	31.18	2.89	82.17	22.83
45	SAGEBEND	-149.40	-50.12	1.11	.523	7.631	235.179	13.98	-3.34	31.38	2.64	82.19	22.83
46	SAGEBEND	-161.31	-51.58	.99	.623	6.388	247.179	13.79	-3.43	31.55	2.41	82.20	22.83
47	SAGEBEND	-173.25	-52.79	.85	.715	5.140	259.179	13.64	-3.51	31.68	2.26	82.21	22.84
48	SAGEBEND	-185.21	-53.73	.70	.803	3.887	271.179	13.51	-3.58	31.79	2.21	82.23	22.84
49	SAGEBEND	-197.19	-54.42	.52	.891	2.631	283.179	13.43	-3.62	31.85	2.19	82.22	22.84
50	SAGEBEND	-209.18	-54.84	.32	.972	1.377	295.179	13.37	-3.65	31.42	1.67	81.72	22.70
51	SAGEBEND	-221.18	-55.00	.12	.947	.220	307.179	13.35	-3.66	22.17	-8.39	73.95	20.54
52	SEABED	-233.18	-55.01	.00	.087	.004	319.179	13.35	-3.66	.59	-14.45	64.72	17.98
53	SEABED	-245.18	-55.01	.00	.004	.000	331.179	13.35	-3.66	.02	-.43	50.71	14.09
54	SEABED	-257.18	-55.01	.00	.000	.000	343.179	13.35	-3.66	.00	-.01	50.29	13.97
55	SEABED	-269.18	-55.01	.00	.000	.000	355.179	13.35	-3.66	.00	.00	50.28	13.97
56	SEABED	-281.18	-55.01	.00	.000	.000	367.179	13.35	-3.66	.00	.00	50.28	13.97
57	SEABED	-293.18	-55.01	.00	.000	.000	379.179	13.35	-3.66	.00	.00	50.28	13.97
58	SEABED	-305.18	-55.01	.00	.000	.000	391.179	13.35	-3.66	.00	.00	50.28	13.97
59	SEABED	-317.18	-55.01	.00	.000	.000	403.179	13.35	-3.66	.00	.00	50.28	13.97

STATIC PIPE COORDINATES, FORCES AND STRESSES

NODE NO.	PIPE SECTION	X	Y	Z	SUPPORT REACTION		SUPT SEPARATIONS		PIPE TENSION	BENDING MOMENTS		
		COORD (M)	COORD (M)	COORD (M)	VERT (KN)	HORIZ (KN)	VERT (M)	HORIZ (M)	(KN)	VERT (KN-M)	HORIZ (KN-M)	TOTAL (KN-M)
1	TENSIONR	77.79	6.21	.00	-.90	.00	.00	.00	350.03	.00	.00	.00
3	LAYBARGE	71.49	6.13	.00	23.88	.00	.00	.00	349.81	-34.69	.00	34.69
5	LAYBARGE	65.37	5.87	.00	13.65	.00	.00	.00	349.62	-25.31	.00	25.31
7	LAYBARGE	59.91	5.48	.00	17.21	.00	.00	.00	349.22	-28.66	.00	28.66
9	LAYBARGE	53.32	4.80	.00	16.06	.00	.00	.00	348.56	-27.67	.00	27.67
11	LAYBARGE	47.32	4.00	.00	20.95	.00	.00	.00	347.73	-33.67	.00	33.67
13	LAYBARGE	38.21	2.41	.00	26.24	.00	.00	.00	346.12	-40.32	.00	40.32
15	LAYBARGE	29.27	.43	.00	20.12	-.13	.00	.00	344.25	-33.28	-.03	33.28
17	LAYBARGE	23.13	-1.18	.00	13.76	-1.02	.00	.00	343.20	-26.42	-.72	26.43
19	LAYBARGE	17.18	-2.95	.00	11.86	1.20	.00	.00	342.20	-24.71	1.50	24.76
21	LAYBARGE	10.63	-5.12	.00	25.69	-5.59	.00	.00	340.79	-43.07	-9.01	44.01
24	STINGER	-1.87	-9.92	.12	10.63	-6.22	.07	.12	338.22	-14.65	-10.29	17.90
26	STINGER	-8.05	-12.39	.26	.00	.00	.35	.26	336.84	3.17	-.54	3.21
28	STINGER	-14.22	-14.83	.40	.00	.00	.88	.41	335.44	5.78	.85	5.84
30	STINGER	-20.38	-17.20	.54	.00	.00	1.70	.55	334.08	6.20	1.04	6.29
32	STINGER	-26.52	-19.49	.67	.00	.00	2.82	.68	332.77	6.31	1.05	6.40
34	STINGER	-32.62	-21.69	.78	.00	.00	4.27	.80	331.51	6.36	1.03	6.45
36	SAGEBEND	-44.35	-25.72	.97	.00	.00	.00	.00	329.20	6.46	1.00	6.54
37	SAGEBEND	-55.77	-29.38	1.11	.00	.00	.00	.00	327.10	6.54	.97	6.62
38	SAGEBEND	-67.27	-32.82	1.22	.00	.00	.00	.00	325.13	6.62	.93	6.69
39	SAGEBEND	-78.84	-36.03	1.29	.00	.00	.00	.00	323.29	6.70	.89	6.76
40	SAGEBEND	-90.47	-38.99	1.34	.00	.00	.00	.00	321.59	6.77	.85	6.83
41	SAGEBEND	-102.16	-41.72	1.35	.00	.00	.00	.00	320.03	6.84	.81	6.89
42	SAGEBEND	-113.90	-44.19	1.33	.00	.00	.00	.00	318.61	6.90	.76	6.94

43	SAGEBEND	-125.69	-46.42	1.28	.00	.00	.00	.00	317.34	6.96	.70	6.99
44	SAGEBEND	-137.53	-48.40	1.21	.00	.00	.00	.00	316.21	7.01	.65	7.04
45	SAGEBEND	-149.40	-50.12	1.11	.00	.00	.00	.00	315.22	7.05	.59	7.08
46	SAGEBEND	-161.31	-51.58	.99	.00	.00	.00	.00	314.38	7.09	.54	7.11
47	SAGEBEND	-173.25	-52.79	.85	.00	.00	.00	.00	313.69	7.12	.51	7.14
48	SAGEBEND	-185.21	-53.73	.70	.00	.00	.00	.00	313.15	7.14	.50	7.16
49	SAGEBEND	-197.19	-54.42	.52	.00	.00	.00	.00	312.76	7.16	.49	7.17
50	SAGEBEND	-209.18	-54.84	.32	.00	.00	.00	.00	312.52	7.06	.38	7.07
51	SAGEBEND	-221.18	-55.00	.12	2.58	-2.63	.00	.00	312.43	4.98	-1.88	5.32
52	SEABED	-233.18	-55.01	.00	7.13	-3.39	.00	.00	312.42	.13	-3.25	3.25
53	SEABED	-245.18	-55.01	.00	6.88	.20	.00	.00	312.42	.00	-.10	.10
54	SEABED	-257.18	-55.01	.00	6.88	.01	.00	.00	312.42	.00	.00	.00
55	SEABED	-269.18	-55.01	.00	6.88	.00	.00	.00	312.42	.00	.00	.00
56	SEABED	-281.18	-55.01	.00	6.88	.00	.00	.00	312.42	.00	.00	.00
57	SEABED	-293.18	-55.01	.00	6.88	.00	.00	.00	312.42	.00	.00	.00
58	SEABED	-305.18	-55.01	.00	6.88	.00	.00	.00	312.42	.00	.00	.00
59	SEABED	-317.18	-55.01	.00	.00	.00	.00	.00	312.42	.00	.00	.00

STATIC SOLUTION SUMMARY

PIPE PROPERTIES (1)

PIPE SECTION LENGTH ..	12.00 M	ELASTIC MODULUS	207000. MPA
OUTSIDE DIAMETER	16.827 CM	CROSS SECTIONAL AREA .	278.27 CM2
WALL THICKNESS	1.270 CM	MOMENT OF INERTIA	1890.46 CM4
WEIGHT/LENGTH IN AIR .	976.987 N/M	YIELD STRESS	360.00 MPA
SUBMERGED WGT/LENG ..	572.993 N/M	STRESS INTENS FACTOR .	1.000
SPECIFIC GRAVITY	2.418	STEEL DENSITY	76982.0 N/M3
WRAP COAT THICKNESS ..	.400 CM	WRAP COAT DENSITY	12567.0 N/M3
CONCRETE THICKNESS ...	2.500 CM	CONCRETE DENSITY	29856.0 N/M3

BARGE DATA

TOTAL PIPE TENSION ...	350.03 KN	RADIUS OF CURVATURE ..	200.00 M
NUMBER OF TENSIONERS .	1	BARGE TRIM ANGLE000 DEG
NO. OF PIPE SUPPORTS .	10	PIPE ANGLE AT STERN ..	19.729 DEG
BARGE HEADING000 DEG	OFFSET FROM R.O.W.00 M

STINGER DATA

NO. OF PIPE SUPPORTS .	6	STINGER STERN DEPTH ..	-21.69 M
NO. STINGER SECTIONS .	6	PIPE ANGLE AT STERN ..	19.532 DEG
RADIUS OF CURVATURE ..	200.00 M	STINGER LENGTH	47.09 M

SAGEBEND DATA

WATER DEPTH	55.00 M	HORIZ PIPE TENSION ...	312.42 KN
TOUCHDOWN X-COORD. ...	-221.87 M	BOTTOM SLOPE ANGLE000 DEG

===== SOLUTION SUMMARY =====

NODE	PIPE	X	Y	Z	SUPPORT	REACT	TOTAL	TOTAL	PCT
NO.	SECTION	COORD	COORD	COORD	VERT	HORIZ	MOMENT	STRESS	YLD
1	TENSIONR	77.8	6.2	.0	-.9	.0	.0	56.4	16.
3	LAYBARGE	71.5	6.1	.0	23.9	.0	34.7	210.8	59.
5	LAYBARGE	65.4	5.9	.0	13.7	.0	25.3	169.0	47.
7	LAYBARGE	59.9	5.5	.0	17.2	.0	28.7	183.8	51.
9	LAYBARGE	53.3	4.8	.0	16.1	.0	27.7	179.3	50.
11	LAYBARGE	47.3	4.0	.0	20.9	.0	33.7	205.9	57.
13	LAYBARGE	38.2	2.4	.0	26.2	.0	40.3	235.2	65.
15	LAYBARGE	29.3	.4	.0	20.1	-.1	33.3	203.6	57.
17	LAYBARGE	23.1	-1.2	.0	13.8	-1.0	26.4	172.9	48.
19	LAYBARGE	17.2	-2.9	.0	11.9	1.2	24.8	165.3	46.
21	LAYBARGE	10.6	-5.1	.0	25.7	-5.6	44.0	250.7	70.
24	STINGER	-1.9	-9.9	.1	10.6	-6.2	17.9	134.1	37.
26	STINGER	-8.1	-12.4	.3	.0	.0	3.2	68.5	19.
28	STINGER	-14.2	-14.8	.4	.0	.0	5.8	80.0	22.
30	STINGER	-20.4	-17.2	.5	.0	.0	6.3	81.8	23.
32	STINGER	-26.5	-19.5	.7	.0	.0	6.4	82.0	23.

OFFPIPE - OFFSHORE PIPELINE ANALYSIS SYSTEM - VERSION 2.05 AC PAGE 88

JOB NO. - TUGAS AKHIR LICENSED TO: RICKY TAMEKAL

USER ID - IDA BAGUS FUNDHARA S DATE - 4/20/2020 TIME - 22:41:42 CASE 4

===== S T A T I C S O L U T I O N S U M M A R Y =====

34	STINGER	-32.6	-21.7	.8	.0	.0	6.4	82.1	23.
48	SAGBEND	-185.2	-53.7	.7	.0	.0	7.2	82.2	23.
52	SEABED	-233.2	-55.0	.0	7.1	-3.4	3.3	64.7	18.

NODE NO.	PIPE SECTION	X COORD (M)	Y COORD (M)	Z COORD (M)	HORIZ ANGLE (DEG)	VERT ANGLE (DEG)	PIPE LENGIH (M)	TENSILE STRESS (MPA)	HOOP STRESS (MPA)	BENDING VERT (MPA)	SIRESSES HORIZ (MPA)	TOTAL STRESS (MPA)	PERCNT YIELD (PCT)
1	TENSIONR	77.79	6.21	.00	.000	.318	.000	13.39	.00	.00	.00	56.39	15.66
3	LAYBARGE	71.49	6.16	.00	.000	.958	6.300	13.37	.00	-108.81	-.01	165.17	45.88
5	LAYBARGE	65.37	5.98	.00	.000	2.220	12.417	13.34	.00	-78.64	.01	134.98	37.50
7	LAYBARGE	59.91	5.72	.00	.000	3.299	17.887	13.30	.00	-89.64	.00	145.94	40.54
9	LAYBARGE	53.32	5.27	.00	.000	4.483	24.493	13.23	.00	-86.29	.00	142.52	39.59
11	LAYBARGE	47.32	4.74	.00	.000	5.786	30.515	13.14	.00	-106.91	.00	163.05	45.29
13	LAYBARGE	38.21	3.69	.00	.000	7.420	39.683	13.97	.00	-129.42	.00	185.39	51.50
15	LAYBARGE	29.27	2.39	.00	.000	9.059	48.722	13.77	.00	-105.96	.01	161.73	44.92
17	LAYBARGE	23.13	1.33	.00	.000	10.380	54.950	13.61	.00	-87.48	-.07	143.10	39.75
19	LAYBARGE	17.18	.19	.00	.002	11.410	61.011	13.43	.00	-69.88	.33	125.31	34.81
21	LAYBARGE	10.63	-1.22	.00	-.026	13.210	67.716	13.22	-.08	-167.43	-6.52	222.82	61.89
24	STINGER	-4.62	-5.11	.00	.028	15.356	83.451	13.73	-.34	-166.98	-6.23	221.99	61.66
26	STINGER	-11.02	-6.99	.00	-.012	17.150	90.118	13.51	-.47	-67.35	-1.71	122.12	33.92
28	STINGER	-17.37	-9.02	.00	.031	18.335	96.785	13.24	-.60	-93.41	3.45	148.01	41.12
30	STINGER	-23.67	-11.19	.00	-.139	19.514	103.452	13.97	-.74	-66.35	-26.10	125.65	34.90
32	STINGER	-29.94	-13.47	.05	-.801	20.547	110.119	13.67	-.90	-75.45	-52.16	145.85	40.51
34	STINGER	-36.16	-15.84	.17	-1.270	20.924	116.786	13.38	-1.05	12.54	-3.65	66.97	18.60
36	SAGEBEND	-47.40	-20.05	.41	-1.162	19.976	128.786	13.84	-1.33	27.43	4.24	81.26	22.57
37	SAGEBEND	-58.72	-24.04	.62	-.974	18.863	140.787	13.32	-1.60	28.54	4.50	82.03	22.79
38	SAGEBEND	-70.11	-27.80	.80	-.788	17.728	152.787	13.84	-1.85	28.96	4.38	82.07	22.80
39	SAGEBEND	-81.57	-31.34	.94	-.610	16.577	164.787	13.39	-2.09	29.33	4.21	82.08	22.80
40	SAGEBEND	-93.11	-34.65	1.04	-.440	15.413	176.788	13.96	-2.31	29.68	4.05	82.09	22.80
41	SAGEBEND	-104.71	-37.72	1.12	-.277	14.235	188.788	13.57	-2.51	30.00	3.88	82.11	22.81
42	SAGEBEND	-116.37	-40.55	1.16	-.123	13.044	200.788	13.20	-2.70	30.31	3.69	82.12	22.81
43	SAGEBEND	-128.09	-43.14	1.17	.022	11.842	212.788	13.87	-2.87	30.60	3.48	82.14	22.82
44	SAGEBEND	-139.86	-45.47	1.15	.158	10.629	224.789	13.57	-3.03	30.85	3.24	82.15	22.82

45	SAGEBND	-151.68	-47.56	1.10	.283	9.406	236.789	13.30	-3.17	31.09	3.00	82.17	22.82
46	SAGEBND	-163.54	-49.39	1.03	.398	8.174	248.789	13.07	-3.29	31.30	2.75	82.18	22.83
47	SAGEBND	-175.43	-50.97	.94	.503	6.935	260.789	13.87	-3.39	31.48	2.50	82.19	22.83
48	SAGEBND	-187.36	-52.29	.82	.598	5.690	272.790	13.70	-3.48	31.63	2.30	82.21	22.83
49	SAGEBND	-199.31	-53.35	.69	.686	4.439	284.790	13.56	-3.55	31.75	2.21	82.22	22.84
50	SAGEBND	-211.28	-54.15	.54	.774	3.183	296.790	13.46	-3.61	31.84	2.20	82.23	22.84
51	SAGEBND	-223.27	-54.68	.37	.859	1.926	308.790	13.39	-3.64	31.77	2.03	82.11	22.81
52	SAGEBND	-235.26	-54.96	.18	.909	.694	320.790	13.36	-3.66	29.32	-1.32	79.59	22.11
53	SEABED	-247.26	-55.01	.02	.400	-.005	332.791	13.35	-3.66	1.80	-23.60	73.92	20.53
54	SEABED	-259.26	-55.01	.00	-.001	.001	344.791	13.35	-3.66	.06	-.55	50.83	14.12
55	SEABED	-271.26	-55.01	.00	.000	.000	356.791	13.35	-3.66	.00	-.02	50.30	13.97
56	SEABED	-283.26	-55.01	.00	.000	.000	368.791	13.35	-3.66	.00	.00	50.28	13.97
57	SEABED	-295.26	-55.01	.00	.000	.000	380.791	13.35	-3.66	.00	.00	50.28	13.97
58	SEABED	-307.26	-55.01	.00	.000	.000	392.791	13.35	-3.66	.00	.00	50.28	13.97
59	SEABED	-319.26	-55.01	.00	.000	.000	404.791	13.35	-3.66	.00	.00	50.28	13.97

STATIC PIPE COORDINATES, FORCES AND STRESSES

NODE NO.	PIPE SECTION	X	Y	Z	SUPPORT REACTION		SUPT SEPARATIONS		PIPE TENSION	BENDING MOMENTS		
		COORD (M)	COORD (M)	COORD (M)	VERT (KN)	HORIZ (KN)	VERT (M)	HORIZ (M)	(KN)	VERT (KN-M)	HORIZ (KN-M)	TOTAL (KN-M)
1	TENSIONR	77.79	6.21	.00	.07	.00	.00	.00	350.00	.00	.00	.00
3	LAYBARGE	71.49	6.16	.00	18.24	.00	.00	.00	349.87	-24.45	.00	24.45
5	LAYBARGE	65.37	5.98	.00	10.85	.00	.00	.00	349.74	-17.67	.00	17.67
7	LAYBARGE	59.91	5.72	.00	13.49	.00	.00	.00	349.47	-20.14	.00	20.14
9	LAYBARGE	53.32	5.27	.00	12.61	.00	.00	.00	349.04	-19.39	.00	19.39
11	LAYBARGE	47.32	4.74	.00	16.42	.00	.00	.00	348.49	-24.02	.00	24.02
13	LAYBARGE	38.21	3.69	.00	20.50	.00	.00	.00	347.43	-29.08	.00	29.08
15	LAYBARGE	29.27	2.39	.00	16.26	.00	.00	.00	346.19	-23.81	.00	23.81
17	LAYBARGE	23.13	1.33	.00	12.96	-.02	.00	.00	345.19	-19.66	-.02	19.66
19	LAYBARGE	17.18	.19	.00	8.36	-.05	.00	.00	344.08	-15.70	.07	15.70
21	LAYBARGE	10.63	-1.22	.00	22.52	-1.32	.00	.00	343.05	-37.62	-1.47	37.65
24	STINGER	-4.62	-5.11	.00	22.29	-1.26	.00	.00	340.83	-37.52	-1.40	37.54
26	STINGER	-11.02	-6.99	.00	6.97	-.68	.00	.00	339.90	-15.13	-.38	15.14
28	STINGER	-17.37	-9.02	.00	12.94	.52	.00	.00	338.71	-20.99	.78	21.00
30	STINGER	-23.67	-11.19	.00	8.53	-3.10	.00	.00	337.49	-14.91	-5.87	16.02
32	STINGER	-29.94	-13.47	.05	11.98	-6.99	.03	.05	336.16	-16.95	-11.72	20.61
34	STINGER	-36.16	-15.84	.17	.00	.00	.10	.17	334.85	2.82	-.82	2.93
36	SAGEBEND	-47.40	-20.05	.41	.00	.00	.00	.00	332.44	6.16	.95	6.24
37	SAGEBEND	-58.72	-24.04	.62	.00	.00	.00	.00	330.15	6.41	1.01	6.49
38	SAGEBEND	-70.11	-27.80	.80	.00	.00	.00	.00	328.00	6.51	.99	6.58
39	SAGEBEND	-81.57	-31.34	.94	.00	.00	.00	.00	325.97	6.59	.95	6.66
40	SAGEBEND	-93.11	-34.65	1.04	.00	.00	.00	.00	324.07	6.67	.91	6.73
41	SAGEBEND	-104.71	-37.72	1.12	.00	.00	.00	.00	322.31	6.74	.87	6.80
42	SAGEBEND	-116.37	-40.55	1.16	.00	.00	.00	.00	320.69	6.81	.83	6.86

43	SAGEBEND	-128.09	-43.14	1.17	.00	.00	.00	.00	319.21	6.87	.78	6.92
44	SAGEBEND	-139.86	-45.47	1.15	.00	.00	.00	.00	317.87	6.93	.73	6.97
45	SAGEBEND	-151.68	-47.56	1.10	.00	.00	.00	.00	316.67	6.99	.67	7.02
46	SAGEBEND	-163.54	-49.39	1.03	.00	.00	.00	.00	315.62	7.03	.62	7.06
47	SAGEBEND	-175.43	-50.97	.94	.00	.00	.00	.00	314.72	7.07	.56	7.09
48	SAGEBEND	-187.36	-52.29	.82	.00	.00	.00	.00	313.96	7.11	.52	7.13
49	SAGEBEND	-199.31	-53.35	.69	.00	.00	.00	.00	313.36	7.13	.50	7.15
50	SAGEBEND	-211.28	-54.15	.54	.00	.00	.00	.00	312.90	7.15	.50	7.17
51	SAGEBEND	-223.27	-54.68	.37	.00	.00	.00	.00	312.59	7.14	.46	7.15
52	SAGEBEND	-235.26	-54.96	.18	.40	-.45	.00	.00	312.44	6.59	-.30	6.59
53	SEABED	-247.26	-55.01	.02	6.26	-4.81	.00	.00	312.42	.40	-5.30	5.32
54	SEABED	-259.26	-55.01	.00	6.91	.07	.00	.00	312.42	.01	-.12	.12
55	SEABED	-271.26	-55.01	.00	6.88	.01	.00	.00	312.42	.00	.00	.00
56	SEABED	-283.26	-55.01	.00	6.88	.00	.00	.00	312.42	.00	.00	.00
57	SEABED	-295.26	-55.01	.00	6.88	.00	.00	.00	312.42	.00	.00	.00
58	SEABED	-307.26	-55.01	.00	6.88	.00	.00	.00	312.42	.00	.00	.00
59	SEABED	-319.26	-55.01	.00	.00	.00	.00	.00	312.42	.00	.00	.00

OFFPIPE - OFFSHORE PIPELINE ANALYSIS SYSTEM - VERSION 2.05 AC PAGE 88

JOB NO. - TUGAS AKHIR LICENSED TO: RICKY TAMEKAL

USER ID - IDA BAGUS FUNDHARA S DATE - 4/20/2020 TIME - 22:41:42 CASE 5

STATIC SOLUTION SUMMARY

PIPE PROPERTIES (1)

PIPE SECTION LENGH ..	12.00 M	ELASTIC MDULUS	207000. MPA
OUTSIDE DIAMETER	16.827 CM	CROSS SECTIONAL AREA .	278.27 CM2
WALL THICKNESS	1.270 CM	MOMENT OF INERTIA	1890.46 CM4
WEIGHT/LENGH IN AIR .	976.987 N/M	YIELD STRESS	360.00 MPA
SUBMERGED WGHT/LENG ..	572.993 N/M	STRESS INIENS FACTOR .	1.000
SPECIFIC GRAVITY	2.418	STEEL DENSITY	76982.0 N/M3
WRAP COAT THICKNESS ..	.400 CM	WRAP COAT DENSITY	12567.0 N/M3
CONCRETE THICKNESS ...	2.500 CM	CONCRETE DENSITY	29856.0 N/M3

ARGE DATA

TOTAL PIPE TENSION ...	350.00 KN	RADIUS OF CURVAITURE ..	300.00 M
------------------------	-----------	-------------------------	----------

NUMBER OF TENSIONERS . 1 BARGE TRIM ANGLE000 DEG
 NO. OF PIPE SUPPORTS . 10 PIPE ANGLE AT STERN .. 13.210 DEG
 BARGE HEADING000 DEG OFFSET FROM R.O.W.00 M

STINGER DATA

=====

NO. OF PIPE SUPPORTS . 6 STINGER STERN DEPTH .. -15.84 M
 NO. STINGER SECTIONS . 6 PIPE ANGLE AT STERN .. 20.924 DEG
 RADIUS OF CURVATURE .. 300.00 M STINGER LENGTH 43.24 M

SAGEBEND DATA

=====

WATER DEPTH 55.00 M HORIZ PIPE TENSION ... 312.42 KN
 TOUCHDOWN X-COORD. ... -241.16 M BOTTOM SLOPE ANGLE000 DEG

===== SOLUTION SUMMARY =====

NODE	PIPE	X	Y	Z	SUPPORT	REACT	TOTAL	TOTAL	PCT
NO.	SECTION	COORD	COORD	COORD	VERT	HORIZ	MOMENT	STRESS	YLD
1	TENSIONR	77.8	6.2	.0	.1	.0	.0	56.4	16.
3	LAYBARGE	71.5	6.2	.0	18.2	.0	24.4	165.2	46.
5	LAYBARGE	65.4	6.0	.0	10.8	.0	17.7	135.0	37.
7	LAYBARGE	59.9	5.7	.0	13.5	.0	20.1	145.9	41.
9	LAYBARGE	53.3	5.3	.0	12.6	.0	19.4	142.5	40.
11	LAYBARGE	47.3	4.7	.0	16.4	.0	24.0	163.1	45.
13	LAYBARGE	38.2	3.7	.0	20.5	.0	29.1	185.4	51.
15	LAYBARGE	29.3	2.4	.0	16.3	.0	23.8	161.7	45.
17	LAYBARGE	23.1	1.3	.0	13.0	.0	19.7	143.1	40.
19	LAYBARGE	17.2	.2	.0	8.4	-.1	15.7	125.3	35.
21	LAYBARGE	10.6	-1.2	.0	22.5	-1.3	37.6	222.8	62.
24	STINGER	-4.6	-5.1	.0	22.3	-1.3	37.5	222.0	62.
26	STINGER	-11.0	-7.0	.0	7.0	-.7	15.1	122.1	34.
28	STINGER	-17.4	-9.0	.0	12.9	.5	21.0	148.0	41.
30	STINGER	-23.7	-11.2	.0	8.5	-3.1	16.0	125.6	35.
32	STINGER	-29.9	-13.5	.0	12.0	-7.0	20.6	145.9	41.

STATIC SOLUTION SUMMARY

34	STINGER	-36.2	-15.8	.2	.0	.0	2.9	67.0	19.
50	SAGEBEND	-211.3	-54.1	.5	.0	.0	7.2	82.2	23.
53	SEABED	-247.3	-55.0	.0	6.3	-4.8	5.3	73.9	21.

STATIC PIPE COORDINATES, FORCES AND STRESSES

NODE NO.	PIPE SECTION	X COORD (M)	Y COORD (M)	Z COORD (M)	HORIZ ANGLE (DEG)	VERT ANGLE (DEG)	PIPE LENGTH (M)	TENSILE STRESS (MPA)	HOOP STRESS (MPA)	BENDING STRESSES VERT (MPA)	HORIZ (MPA)	TOTAL STRESS (MPA)	PERCENT YIELD (PCT)
1	TENSIONR	77.79	6.21	.00	.000	.257	.000	13.40	.00	.00	.00	56.40	15.67
3	LAYBARGE	71.49	6.17	.00	.000	.715	6.300	13.39	.00	-86.02	-.01	142.40	39.56
5	LAYBARGE	65.37	6.04	.00	.000	1.663	12.416	13.37	.00	-61.64	.00	118.01	32.78
7	LAYBARGE	59.91	5.84	.00	.000	2.477	17.883	13.34	.00	-70.73	.00	127.07	35.30
9	LAYBARGE	53.32	5.51	.00	.000	3.356	24.482	13.28	.00	-67.92	.00	124.21	34.50
11	LAYBARGE	47.32	5.11	.00	.000	4.349	30.493	13.22	.00	-85.62	.00	141.84	39.40
13	LAYBARGE	38.21	4.33	.00	.000	5.557	39.635	13.09	.00	-104.92	-.01	161.01	44.72
15	LAYBARGE	29.27	3.35	.00	.000	6.772	48.632	13.94	.00	-84.68	.05	140.62	39.06
17	LAYBARGE	23.13	2.57	.00	-.001	7.770	54.820	13.82	.00	-68.63	-.25	124.45	34.57
19	LAYBARGE	17.18	1.71	.00	.006	8.525	60.832	13.69	.00	-54.03	1.13	109.73	30.48
21	LAYBARGE	10.63	.66	.00	-.027	9.961	67.470	13.50	.00	-151.67	-5.03	207.26	57.57
24	STINGER	-5.62	-2.41	.00	.022	11.487	84.004	13.09	-.16	-148.16	-5.86	203.44	56.51
26	STINGER	-12.13	-3.85	.00	-.002	12.967	90.671	13.93	-.26	-48.90	-.25	103.96	28.88
28	STINGER	-18.62	-5.39	.00	-.012	13.818	97.338	13.73	-.36	-72.17	-4.14	127.19	35.33

30	STINGER	-25.08	-7.03	.00	.059	14.750	104.005	13.52	-.47	-58.52	9.17	113.99	31.66
32	STINGER	-31.51	-8.77	-.01	.112	15.389	110.672	13.29	-.58	-36.74	-6.30	91.87	25.52
34	STINGER	-37.91	-10.65	.00	-.607	18.418	117.339	13.93	-.71	-345.53	-81.52	321.29	85.69
36	SAGEBEND	-49.13	-14.90	.24	-1.332	21.130	129.339	13.50	-.99	9.37	.58	63.39	17.61
37	SAGEBEND	-60.35	-19.15	.48	-1.177	20.216	141.339	13.95	-1.27	27.19	4.49	81.15	22.54
38	SAGEBEND	-71.64	-23.18	.70	-.985	19.109	153.339	13.44	-1.54	28.45	4.54	82.03	22.78
39	SAGEBEND	-83.02	-27.00	.87	-.798	17.977	165.339	13.95	-1.80	28.88	4.42	82.07	22.80
40	SAGEBEND	-94.47	-30.59	1.02	-.618	16.830	177.339	13.48	-2.04	29.25	4.25	82.08	22.80
41	SAGEBEND	-105.99	-33.95	1.12	-.446	15.668	189.339	13.05	-2.26	29.60	4.08	82.09	22.80
42	SAGEBEND	-117.58	-37.07	1.20	-.282	14.493	201.339	13.65	-2.47	29.93	3.92	82.10	22.81
43	SAGEBEND	-129.22	-39.95	1.24	-.126	13.305	213.339	13.28	-2.66	30.25	3.73	82.12	22.81
44	SAGEBEND	-140.93	-42.59	1.25	.022	12.105	225.339	13.94	-2.84	30.53	3.53	82.14	22.82
45	SAGEBEND	-152.69	-44.98	1.23	.159	10.894	237.339	13.64	-3.00	30.80	3.29	82.15	22.82
46	SAGEBEND	-164.50	-47.13	1.18	.287	9.674	249.340	13.36	-3.14	31.04	3.05	82.17	22.82
47	SAGEBEND	-176.35	-49.02	1.11	.404	8.444	261.340	13.12	-3.26	31.25	2.80	82.18	22.83
48	SAGEBEND	-188.23	-50.65	1.02	.511	7.207	273.340	13.91	-3.37	31.44	2.55	82.19	22.83
49	SAGEBEND	-200.15	-52.03	.90	.608	5.962	285.340	13.73	-3.46	31.60	2.34	82.20	22.83
50	SAGEBEND	-212.10	-53.14	.76	.698	4.712	297.341	13.59	-3.54	31.72	2.23	82.22	22.84
51	SAGEBEND	-224.07	-54.00	.61	.785	3.458	309.341	13.48	-3.60	31.82	2.21	82.23	22.84
52	SAGEBEND	-236.05	-54.59	.43	.872	2.201	321.341	13.41	-3.63	31.81	2.14	82.17	22.82
53	SAGEBEND	-248.05	-54.92	.24	.944	.957	333.342	13.36	-3.66	30.38	.70	80.64	22.40
54	SEABED	-260.05	-55.01	.06	.706	.026	345.342	13.35	-3.66	7.06	-20.63	72.06	20.02
55	SEABED	-272.05	-55.01	.00	-.004	.003	357.342	13.35	-3.66	.22	-2.28	52.57	14.60
56	SEABED	-284.05	-55.01	.00	.001	.000	369.342	13.35	-3.66	.01	-.08	50.36	13.99
57	SEABED	-296.05	-55.01	.00	.000	.000	381.342	13.35	-3.66	.00	.00	50.28	13.97
58	SEABED	-308.05	-55.01	.00	.000	.000	393.342	13.35	-3.66	.00	.00	50.28	13.97
59	SEABED	-320.05	-55.01	.00	.000	.000	405.342	13.35	-3.66	.00	.00	50.28	13.97
60	SEABED	-332.05	-55.01	.00	.000	.000	417.342	13.35	-3.66	.00	.00	50.28	13.97
61	SEABED	-344.05	-55.01	.00	.000	.000	429.342	13.35	-3.66	.00	.00	50.28	13.97

STATIC PIPE COORDINATES, FORCES AND STRESSES

NODE NO.	PIPE SECTION	X	Y	Z	SUPPORT REACTION		SUPT SEPARATIONS		PIPE TENSION (KN)	BENDING MOMENTS		
		COORD (M)	COORD (M)	COORD (M)	VERT (KN)	HORIZ (KN)	VERT (M)	HORIZ (M)		VERT (KN-M)	HORIZ (KN-M)	TOTAL (KN-M)
1	TENSIONR	77.79	6.21	.00	.55	.00	.00	.00	350.08	.00	.00	.00
3	LAYBARGE	71.49	6.17	.00	15.42	.00	.00	.00	350.00	-19.33	.00	19.33
5	LAYBARGE	65.37	6.04	.00	9.45	.00	.00	.00	349.89	-13.85	.00	13.85
7	LAYBARGE	59.91	5.84	.00	11.63	.00	.00	.00	349.69	-15.89	.00	15.89
9	LAYBARGE	53.32	5.51	.00	10.90	.00	.00	.00	349.37	-15.26	.00	15.26
11	LAYBARGE	47.32	5.11	.00	14.18	.00	.00	.00	348.96	-19.24	.00	19.24
13	LAYBARGE	38.21	4.33	.00	17.69	.00	.00	.00	348.17	-23.57	.00	23.57
15	LAYBARGE	29.27	3.35	.00	14.04	.01	.00	.00	347.24	-19.03	.01	19.03
17	LAYBARGE	23.13	2.57	.00	11.15	-.06	.00	.00	346.49	-15.42	-.06	15.42
19	LAYBARGE	17.18	1.71	.00	7.72	.26	.00	.00	345.67	-12.14	.25	12.14
21	LAYBARGE	10.63	.66	.00	21.89	-.86	.00	.00	344.52	-34.08	-1.13	34.10
24	STINGER	-5.62	-2.41	.00	20.46	-1.19	.00	.00	342.49	-33.29	-1.32	33.32
26	STINGER	-12.13	-3.85	.00	5.29	-.35	.00	.00	341.79	-10.99	-.06	10.99
28	STINGER	-18.62	-5.39	.00	10.63	-1.24	.00	.00	340.89	-16.22	-.93	16.24
30	STINGER	-25.08	-7.03	.00	8.71	.96	.00	.00	339.96	-13.15	2.06	13.31
32	STINGER	-31.51	-8.77	-.01	.00	.00	.02	-.01	338.98	-8.26	-1.42	8.38
34	STINGER	-37.91	-10.65	.00	47.85	-10.97	.00	.00	337.11	-77.64	-18.32	79.77
36	SAGEBEND	-49.13	-14.90	.24	.00	.00	.00	.00	335.41	2.11	.13	2.11
37	SAGEBEND	-60.35	-19.15	.48	.00	.00	.00	.00	332.97	6.11	1.01	6.19
38	SAGEBEND	-71.64	-23.18	.70	.00	.00	.00	.00	330.66	6.39	1.02	6.47
39	SAGEBEND	-83.02	-27.00	.87	.00	.00	.00	.00	328.47	6.49	.99	6.56
40	SAGEBEND	-94.47	-30.59	1.02	.00	.00	.00	.00	326.41	6.57	.96	6.64
41	SAGEBEND	-105.99	-33.95	1.12	.00	.00	.00	.00	324.49	6.65	.92	6.71
42	SAGEBEND	-117.58	-37.07	1.20	.00	.00	.00	.00	322.70	6.73	.88	6.78
43	SAGEBEND	-129.22	-39.95	1.24	.00	.00	.00	.00	321.05	6.80	.84	6.85

44	SAGEBND	-140.93	-42.59	1.25	.00	.00	.00	.00	319.53	6.86	.79	6.91
45	SAGEBND	-152.69	-44.98	1.23	.00	.00	.00	.00	318.16	6.92	.74	6.96
46	SAGEBND	-164.50	-47.13	1.18	.00	.00	.00	.00	316.94	6.97	.69	7.01
47	SAGEBND	-176.35	-49.02	1.11	.00	.00	.00	.00	315.85	7.02	.63	7.05
48	SAGEBND	-188.23	-50.65	1.02	.00	.00	.00	.00	314.92	7.06	.57	7.09
49	SAGEBND	-200.15	-52.03	.90	.00	.00	.00	.00	314.13	7.10	.53	7.12
50	SAGEBND	-212.10	-53.14	.76	.00	.00	.00	.00	313.49	7.13	.50	7.15
51	SAGEBND	-224.07	-54.00	.61	.00	.00	.00	.00	313.00	7.15	.50	7.17
52	SAGEBND	-236.05	-54.59	.43	.00	.00	.00	.00	312.66	7.15	.48	7.16
53	SAGEBND	-248.05	-54.92	.24	.06	-.06	.00	.00	312.47	6.83	.16	6.83
54	SEABED	-260.05	-55.01	.06	5.02	-4.76	.00	.00	312.43	1.59	-4.64	4.90
55	SEABED	-272.05	-55.01	.00	6.99	-.94	.00	.00	312.42	.05	-.51	.51
56	SEABED	-284.05	-55.01	.00	6.88	.04	.00	.00	312.42	.00	-.02	.02
57	SEABED	-296.05	-55.01	.00	6.88	.00	.00	.00	312.42	.00	.00	.00
58	SEABED	-308.05	-55.01	.00	6.88	.00	.00	.00	312.42	.00	.00	.00
59	SEABED	-320.05	-55.01	.00	6.88	.00	.00	.00	312.42	.00	.00	.00
60	SEABED	-332.05	-55.01	.00	6.88	.00	.00	.00	312.42	.00	.00	.00
61	SEABED	-344.05	-55.01	.00	.00	.00	.00	.00	312.42	.00	.00	.00

STATIC SOLUTION SUMMARY

PIPE PROPERTIES (1)

PIPE SECTION LENGTH ..	12.00 M	ELASTIC MODULUS	207000. MPA
OUTSIDE DIAMETER	16.827 CM	CROSS SECTIONAL AREA .	278.27 CM2
WALL THICKNESS	1.270 CM	MOMENT OF INERTIA	1890.46 CM4
WEIGHT/LENGTH IN AIR .	976.987 N/M	YIELD STRESS	360.00 MPA
SUBMERGED WGT/LENG ..	572.993 N/M	STRESS INTENS FACTOR .	1.000
SPECIFIC GRAVITY	2.418	STEEL DENSITY	76982.0 N/M3
WRAP COAT THICKNESS ..	.400 CM	WRAP COAT DENSITY	12567.0 N/M3
CONCRETE THICKNESS ...	2.500 CM	CONCRETE DENSITY	29856.0 N/M3

BARGE DATA

TOTAL PIPE TENSION ...	350.08 KN	RADIUS OF CURVATURE ..	400.00 M
NUMBER OF TENSIONERS .	1	BARGE TRIM ANGLE000 DEG
NO. OF PIPE SUPPORTS .	10	PIPE ANGLE AT STERN ..	9.961 DEG
BARGE HEADING000 DEG	OFFSET FROM R.O.W.00 M

STINGER DATA

NO. OF PIPE SUPPORTS .	6	STINGER STERN DEPTH ..	-10.65 M
NO. STINGER SECTIONS .	6	PIPE ANGLE AT STERN ..	18.418 DEG
RADIUS OF CURVATURE ..	400.00 M	STINGER LENGTH	41.60 M

SAGEBEND DATA

WATER DEPTH	55.00 M	HORIZ PIPE TENSION ...	312.42 KN
TOUCHDOWN X-COORD. ...	-256.60 M	BOTTOM SLOPE ANGLE000 DEG

SOLUTION SUMMARY

NODE	PIPE	X	Y	Z	SUPPORT	REACT	TOTAL	TOTAL	PCT
NO.	SECTION	COORD	COORD	COORD	VERT	HORIZ	MOMENT	STRESS	YLD

1	TENSIONR	77.8	6.2	.0	.6	.0	.0	56.4	16.
3	LAYBARGE	71.5	6.2	.0	15.4	.0	19.3	142.4	40.
5	LAYBARGE	65.4	6.0	.0	9.5	.0	13.8	118.0	33.
7	LAYBARGE	59.9	5.8	.0	11.6	.0	15.9	127.1	35.
9	LAYBARGE	53.3	5.5	.0	10.9	.0	15.3	124.2	35.
11	LAYBARGE	47.3	5.1	.0	14.2	.0	19.2	141.8	39.
13	LAYBARGE	38.2	4.3	.0	17.7	.0	23.6	161.0	45.
15	LAYBARGE	29.3	3.4	.0	14.0	.0	19.0	140.6	39.
17	LAYBARGE	23.1	2.6	.0	11.2	-.1	15.4	124.5	35.
19	LAYBARGE	17.2	1.7	.0	7.7	.3	12.1	109.7	30.
21	LAYBARGE	10.6	.7	.0	21.9	-.9	34.1	207.3	58.
24	STINGER	-5.6	-2.4	.0	20.5	-1.2	33.3	203.4	57.
26	STINGER	-12.1	-3.8	.0	5.3	-.3	11.0	104.0	29.
28	STINGER	-18.6	-5.4	.0	10.6	-1.2	16.2	127.2	35.
30	STINGER	-25.1	-7.0	.0	8.7	1.0	13.3	114.0	32.
32	STINGER	-31.5	-8.8	.0	.0	.0	8.4	91.9	26.

OFFPIPE - OFFSHORE PIPELINE ANALYSIS SYSTEM - VERSION 2.05 AC PAGE 108

JOB NO. - TUGAS AKHIR LICENSED TO: RICKY TAMEKAL

USER ID - IDA BAGUS FUNDHARA S DATE - 5/ 6/2020 TIME - 21: 6:22 CASE 6

STATIC SOLUTION SUMMARY

34	STINGER	-37.9	-10.7	.0	47.9	-11.0	79.8	409.3	114.
51	SAGEEND	-224.1	-54.0	.6	.0	.0	7.2	82.2	23.
54	SEABED	-260.0	-55.0	.1	5.0	-4.8	4.9	72.1	20.

S T A T I C P I P E C O O R D I N A T E S , F O R C E S A N D S T R E S S E S

NODE NO.	PIPE SECTION	X COORD (M)	Y COORD (M)	Z COORD (M)	HORIZ ANGLE (DEG)	VERT ANGLE (DEG)	PIPE LENGIH (M)	TENSILE STRESS (MPA)	HOOP STRESS (MPA)	BENDING STRESSES VERT (MPA)	HORIZ STRESS (MPA)	TOTAL STRESS (MPA)	PERCNT YIELD (PCT)
1	TENSIONR	77.79	6.21	.00	.000	.259	.000	13.44	.00	.00	.00	64.44	17.90
3	LAYBARGE	71.49	6.17	.00	.000	.716	6.300	13.42	.00	-87.79	-.01	152.21	42.28
5	LAYBARGE	65.37	6.04	.00	.000	1.662	12.416	13.41	.00	-63.24	.00	127.64	35.46
7	LAYBARGE	59.91	5.84	.00	.000	2.479	17.883	13.37	.00	-72.41	.00	136.78	37.99
9	LAYBARGE	53.32	5.51	.00	.000	3.354	24.482	13.32	.00	-69.67	.00	133.99	37.22
11	LAYBARGE	47.32	5.11	.00	.000	4.352	30.493	13.26	.00	-88.38	.00	152.64	42.40
13	LAYBARGE	38.21	4.33	.00	.000	5.557	39.635	13.13	.00	-108.83	-.01	172.96	48.04
15	LAYBARGE	29.27	3.35	.00	.000	6.768	48.632	13.98	.00	-87.44	.05	151.42	42.06
17	LAYBARGE	23.13	2.57	.00	-.001	7.770	54.820	13.86	.00	-70.44	-.23	134.29	37.30
19	LAYBARGE	17.18	1.71	.00	.005	8.520	60.832	13.73	.00	-54.36	1.08	118.09	32.80
21	LAYBARGE	10.63	.66	.00	-.026	10.001	67.470	13.54	.00	-163.18	-4.96	226.79	63.00
24	STINGER	-5.62	-2.46	.00	.023	12.196	84.015	13.10	-.16	-233.82	-5.47	297.06	82.52
26	STINGER	-12.10	-4.04	.00	-.011	14.766	90.682	13.94	-.27	-105.80	-1.98	168.89	46.91
28	STINGER	-18.52	-5.83	.00	.032	16.554	97.350	13.70	-.39	-135.75	3.92	198.70	55.19
30	STINGER	-24.88	-7.84	.00	-.150	18.411	104.017	13.45	-.52	-113.97	-29.11	180.34	50.09
32	STINGER	-31.17	-10.03	.05	-.825	19.868	110.684	13.17	-.67	-85.45	-53.96	163.56	45.43
34	STINGER	-37.43	-12.34	.17	-1.287	20.332	117.352	13.88	-.82	9.94	-3.29	72.76	20.21
36	SAGEBEND	-48.70	-16.43	.42	-1.185	19.508	129.352	13.36	-1.09	23.78	3.83	85.99	23.89
37	SAGEBEND	-60.05	-20.35	.64	-1.016	18.543	141.352	13.85	-1.35	24.70	4.03	86.56	24.05
38	SAGEBEND	-71.45	-24.06	.82	-.851	17.562	153.352	13.38	-1.60	25.01	3.93	86.50	24.03
39	SAGEBEND	-82.92	-27.59	.98	-.690	16.569	165.353	13.93	-1.84	25.28	3.82	86.43	24.01
40	SAGEBEND	-94.45	-30.91	1.10	-.536	15.566	177.353	13.50	-2.06	25.54	3.67	86.35	23.99
41	SAGEBEND	-106.04	-34.03	1.20	-.388	14.553	189.353	13.10	-2.27	25.79	3.53	86.28	23.97
42	SAGEBEND	-117.68	-36.94	1.26	-.247	13.530	201.353	13.73	-2.46	26.02	3.40	86.23	23.95
43	SAGEBEND	-129.37	-39.64	1.30	-.111	12.499	213.354	13.38	-2.64	26.24	3.25	86.17	23.94

44	SAGEBEND	-141.11	-42.13	1.31	.017	11.459	225.354	13.06	-2.81	26.45	3.09	86.12	23.92
45	SAGEBEND	-152.90	-44.41	1.29	.138	10.411	237.354	13.77	-2.96	26.63	2.90	86.08	23.91
46	SAGEBEND	-164.72	-46.47	1.25	.250	9.356	249.354	13.50	-3.09	26.81	2.70	86.03	23.90
47	SAGEBEND	-176.58	-48.31	1.19	.354	8.295	261.354	13.27	-3.22	26.96	2.50	86.00	23.89
48	SAGEBEND	-188.46	-49.93	1.10	.450	7.227	273.355	13.06	-3.32	27.10	2.30	85.97	23.88
49	SAGEBEND	-200.38	-51.33	1.00	.538	6.155	285.355	13.88	-3.42	27.22	2.11	85.94	23.87
50	SAGEBEND	-212.32	-52.50	.88	.618	5.079	297.355	13.73	-3.50	27.32	1.97	85.92	23.87
51	SAGEBEND	-224.29	-53.45	.74	.694	3.998	309.355	13.61	-3.56	27.40	1.91	85.91	23.86
52	SAGEBEND	-236.26	-54.17	.59	.770	2.916	321.355	13.51	-3.61	27.46	1.90	85.90	23.86
53	SAGEBEND	-248.25	-54.67	.42	.844	1.831	333.355	13.45	-3.64	27.43	1.85	85.82	23.84
54	SAGEBEND	-260.25	-54.94	.24	.907	.759	345.355	13.42	-3.66	26.04	.56	84.35	23.43
55	SEABED	-272.25	-55.01	.06	.681	.010	357.356	13.41	-3.66	4.04	-19.48	78.20	21.72
56	SEABED	-284.25	-55.01	.00	.001	.002	369.356	13.41	-3.66	.14	-2.76	61.09	16.97
57	SEABED	-296.25	-55.01	.00	.001	.000	381.356	13.41	-3.66	.00	-.10	58.42	16.23
58	SEABED	-308.25	-55.01	.00	.000	.000	393.356	13.41	-3.66	.00	.00	58.33	16.20
59	SEABED	-320.25	-55.01	.00	.000	.000	405.356	13.41	-3.66	.00	.00	58.32	16.20
60	SEABED	-332.25	-55.01	.00	.000	.000	417.356	13.41	-3.66	.00	.00	58.32	16.20
61	SEABED	-344.25	-55.01	.00	.000	.000	429.356	13.41	-3.66	.00	.00	58.32	16.20

OFFPIPE - OFFSHORE PIPELINE ANALYSIS SYSTEM - VERSION 2.05 AC DATE - 5/ 6/2020 TIME - 21: 6:22 PAGE 106
PROJECT - TUGAS AKHIR JOB NO. - ANALISIS STATIS
USER ID - IDA BAGUS FUNDHARA SAKYANARY LICENSED TO: RICKY TAMEKAL CASE 7

STATIC PIPE COORDINATES, FORCES AND STRESSES

NODE NO.	PIPE SECTION	X	Y	Z	HORIZ	VERT	PIPE	TENSILE	HOOP	BENDING STRESSES		TOTAL	PERCNT
		COORD	COORD	COORD	ANGLE	ANGLE	LENGIH	STRESS	STRESS	VERT	HORIZ	STRESS	YIELD
		(M)	(M)	(M)	(DEG)	(DEG)	(M)	(MPA)	(MPA)	(MPA)	(MPA)	(MPA)	(PCT)
62	SEABED	-356.25	-55.01	.00	.000	.000	441.356	56.41	-3.66	.00	.00	58.32	16.20

OFFPIPE - OFFSHORE PIPELINE ANALYSIS SYSTEM - VERSION 2.05 AC DATE - 5/ 6/2020 TIME - 21: 6:22 PAGE 106
PROJECT - TUGAS AKHIR JOB NO. - ANALISIS STATIS
USER ID - IDA BAGUS FUNDHARA SAKYANARY LICENSED TO: RICKY TAMEKAL CASE 7

STATIC PIPE COORDINATES, FORCES AND STRESSES

NODE NO.	PIPE SECTION	X	Y	Z	SUPPORT REACTION		SUPT SEPARATIONS		PIPE	BENDING MOMENTS		
		COORD	COORD	COORD	VERT	HORIZ	VERT	HORIZ	TENSION	VERT	HORIZ	TOTAL
		(M)	(M)	(M)	(KN)	(KN)	(M)	(M)	(KN)	(KN-M)	(KN-M)	(KN-M)
1	TENSIONR	77.79	6.21	.00	.55	.01	.00	.00	399.97	.00	.00	.00
3	LAYBARGE	71.49	6.17	.00	16.25	.00	.00	.00	399.88	-19.73	.00	19.73
5	LAYBARGE	65.37	6.04	.00	10.17	.00	.00	.00	399.78	-14.21	.00	14.21
7	LAYBARGE	59.91	5.84	.00	12.38	.00	.00	.00	399.58	-16.27	.00	16.27
9	LAYBARGE	53.32	5.51	.00	11.65	.00	.00	.00	399.25	-15.65	.00	15.65
11	LAYBARGE	47.32	5.11	.00	15.13	.00	.00	.00	398.84	-19.86	.00	19.86
13	LAYBARGE	38.21	4.33	.00	18.88	.00	.00	.00	398.05	-24.45	.00	24.45
15	LAYBARGE	29.27	3.35	.00	14.99	.01	.00	.00	397.13	-19.65	.01	19.65
17	LAYBARGE	23.13	2.57	.00	11.93	-.06	.00	.00	396.38	-15.83	-.05	15.83
19	LAYBARGE	17.18	1.71	.00	8.08	.25	.00	.00	395.56	-12.21	.24	12.22
21	LAYBARGE	10.63	.66	.00	23.69	-.86	.00	.00	394.38	-36.66	-1.11	36.68
24	STINGER	-5.62	-2.46	.00	31.80	-1.12	.00	.00	392.19	-52.54	-1.23	52.55

26	STINGER	-12.10	-4.04	.00	11.43	-.75	.00	.00	391.56	-23.77	-.45	23.78
28	STINGER	-18.52	-5.83	.00	18.42	.65	.00	.00	390.49	-30.50	.88	30.51
30	STINGER	-24.88	-7.84	.00	15.19	-3.77	.00	.00	389.37	-25.61	-6.54	26.43
32	STINGER	-31.17	-10.03	.05	13.14	-7.67	.03	.05	388.13	-19.20	-12.12	22.71
34	STINGER	-37.43	-12.34	.17	.00	.00	.15	.17	386.87	2.23	-.74	2.35
36	SAGEBEND	-48.70	-16.43	.42	.00	.00	.00	.00	384.52	5.34	.86	5.41
37	SAGEBEND	-60.05	-20.35	.64	.00	.00	.00	.00	382.28	5.55	.91	5.62
38	SAGEBEND	-71.45	-24.06	.82	.00	.00	.00	.00	380.15	5.62	.88	5.69
39	SAGEBEND	-82.92	-27.59	.98	.00	.00	.00	.00	378.13	5.68	.86	5.74
40	SAGEBEND	-94.45	-30.91	1.10	.00	.00	.00	.00	376.23	5.74	.83	5.80
41	SAGEBEND	-106.04	-34.03	1.20	.00	.00	.00	.00	374.44	5.79	.79	5.85
42	SAGEBEND	-117.68	-36.94	1.26	.00	.00	.00	.00	372.78	5.85	.76	5.90
43	SAGEBEND	-129.37	-39.64	1.30	.00	.00	.00	.00	371.23	5.90	.73	5.94
44	SAGEBEND	-141.11	-42.13	1.31	.00	.00	.00	.00	369.80	5.94	.69	5.98
45	SAGEBEND	-152.90	-44.41	1.29	.00	.00	.00	.00	368.50	5.98	.65	6.02
46	SAGEBEND	-164.72	-46.47	1.25	.00	.00	.00	.00	367.32	6.02	.61	6.05
47	SAGEBEND	-176.58	-48.31	1.19	.00	.00	.00	.00	366.26	6.06	.56	6.08
48	SAGEBEND	-188.46	-49.93	1.10	.00	.00	.00	.00	365.33	6.09	.52	6.11
49	SAGEBEND	-200.38	-51.33	1.00	.00	.00	.00	.00	364.53	6.12	.47	6.13
50	SAGEBEND	-212.32	-52.50	.88	.00	.00	.00	.00	363.86	6.14	.44	6.15
51	SAGEBEND	-224.29	-53.45	.74	.00	.00	.00	.00	363.31	6.16	.43	6.17
52	SAGEBEND	-236.26	-54.17	.59	.00	.00	.00	.00	362.90	6.17	.43	6.18
53	SAGEBEND	-248.25	-54.67	.42	.00	.00	.00	.00	362.61	6.16	.41	6.18
54	SAGEBEND	-260.25	-54.94	.24	.13	-.07	.00	.00	362.46	5.85	.13	5.85
55	SEABED	-272.25	-55.01	.06	5.40	-5.03	.00	.00	362.43	.91	-4.38	4.47
56	SEABED	-284.25	-55.01	.00	6.94	-1.25	.00	.00	362.42	.03	-.62	.62
57	SEABED	-296.25	-55.01	.00	6.88	.05	.00	.00	362.42	.00	-.02	.02
58	SEABED	-308.25	-55.01	.00	6.88	.00	.00	.00	362.42	.00	.00	.00
59	SEABED	-320.25	-55.01	.00	6.88	.00	.00	.00	362.42	.00	.00	.00
60	SEABED	-332.25	-55.01	.00	6.88	.00	.00	.00	362.42	.00	.00	.00
61	SEABED	-344.25	-55.01	.00	6.88	.00	.00	.00	362.42	.00	.00	.00

OFFPIPE - OFFSHORE PIPELINE ANALYSIS SYSTEM - VERSION 2.05 AC

DATE - 5/ 6/2020

TIME - 21: 6:22

PAGE 106

PROJECT - TUGAS AKHIR

JOB NO. - ANALISIS STATIS

USER ID - IIDA BAGUS FUNDHARA SAKYANARY

LICENSED TO: RICKY TAMEKAL

CASE 7

S T A T I C P I P E C O O R D I N A T E S , F O R C E S A N D S T R E S S E S

NODE NO.	PIPE SECTION	X	Y	Z	SUPPORT REACTION		SUPT SEPARATIONS		PIPE TENSION	BENDING MOMENTS		
		COORD (M)	COORD (M)	COORD (M)	VERT (KN)	HORIZ (KN)	VERT (M)	HORIZ (M)	(KN)	VERT (KN-M)	HORIZ (KN-M)	TOTAL (KN-M)
62	SEABED	-356.25	-55.01	.00	.00	.00	.00	.00	362.42	.00	.00	.00

STATIC SOLUTION SUMMARY

PIPE PROPERTIES (1)

PIPE SECTION LENGH ..	12.00 M	ELASTIC MODULUS	207000. MPA
OUTSIDE DIAMETER	16.827 CM	CROSS SECTIONAL AREA .	278.27 CM2
WALL THICKNESS	1.270 CM	MOMENT OF INERTIA	1890.46 CM4
WEIGHT/LENGTH IN AIR .	976.987 N/M	YIELD STRESS	360.00 MPA
SUBMERGED WGH/LENG ..	572.993 N/M	STRESS INIENS FACTOR .	1.000
SPECIFIC GRAVITY	2.418	STEEL DENSITY	76982.0 N/M3
WRAP COAT THICKNESS ..	.400 CM	WRAP COAT DENSITY	12567.0 N/M3
CONCRETE THICKNESS ...	2.500 CM	CONCRETE DENSITY	29856.0 N/M3

BARGE DATA

TOTAL PIPE TENSION ...	399.97 KN	RADIUS OF CURVAITURE ..	400.00 M
NUMBER OF TENSIONERS .	1	BARGE TRIM ANGLE000 DEG
NO. OF PIPE SUPPORTS .	10	PIPE ANGLE AT STERN ..	10.001 DEG
BARGE HEADING000 DEG	OFFSET FROM R.O.W.00 M

STINGER DATA

NO. OF PIPE SUPPORTS .	6	STINGER STERN DEPTH ..	-12.34 M
NO. STINGER SECTIONS .	6	PIPE ANGLE AT STERN ..	20.332 DEG
RADIUS OF CURVAITURE ..	200.00 M	STINGER LENGH	41.63 M

SAGEBEND DATA

WATER DEPTH	55.00 M	HORIZ PIPE TENSION ...	362.42 KN
TOUCHDOWN X-COORD. ...	-267.76 M	BOTTOM SLOPE ANGLE000 DEG

SOLUTION SUMMARY

NODE	PIPE	X	Y	Z	SUPPORT	REACT	TOTAL	TOTAL	PCT
NO.	SECTION	COORD	COORD	COORD	VERT	HORIZ	MOMENT	STRESS	YLD
1	TENSIONR	77.8	6.2	.0	.6	.0	.0	64.4	18.
3	LAYBARGE	71.5	6.2	.0	16.3	.0	19.7	152.2	42.
5	LAYBARGE	65.4	6.0	.0	10.2	.0	14.2	127.6	35.
7	LAYBARGE	59.9	5.8	.0	12.4	.0	16.3	136.8	38.
9	LAYBARGE	53.3	5.5	.0	11.7	.0	15.7	134.0	37.
11	LAYBARGE	47.3	5.1	.0	15.1	.0	19.9	152.6	42.
13	LAYBARGE	38.2	4.3	.0	18.9	.0	24.5	173.0	48.
15	LAYBARGE	29.3	3.4	.0	15.0	.0	19.6	151.4	42.
17	LAYBARGE	23.1	2.6	.0	11.9	-.1	15.8	134.3	37.
19	LAYBARGE	17.2	1.7	.0	8.1	.3	12.2	118.1	33.
21	LAYBARGE	10.6	.7	.0	23.7	-.9	36.7	226.8	63.
24	STINGER	-5.6	-2.5	.0	31.8	-1.1	52.6	297.1	83.
26	STINGER	-12.1	-4.0	.0	11.4	-.7	23.8	168.9	47.
28	STINGER	-18.5	-5.8	.0	18.4	.6	30.5	198.7	55.
30	STINGER	-24.9	-7.8	.0	15.2	-3.8	26.4	180.3	50.
32	STINGER	-31.2	-10.0	.0	13.1	-7.7	22.7	163.6	45.

OFFPIPE - OFFSHORE PIPELINE ANALYSIS SYSTEM - VERSION 2.05 AC PAGE 108

JOB NO. - TUGAS AKHIR LICENSED TO: RICKY TAMEKAL

USER ID - IDA BAGUS FUNDHARA S DATE - 5/ 6/2020 TIME - 21: 6:22 CASE 7

S T A T I C S O L U T I O N S U M M A R Y

34	STINGER	-37.4	-12.3	.2	.0	.0	2.4	72.8	20.
37	SAGEBND	-60.0	-20.3	.6	.0	.0	5.6	86.6	24.
55	SEABED	-272.2	-55.0	.1	5.4	-5.0	4.5	78.2	22.

STATIC PIPE COORDINATES, FORCES AND STRESSES

NODE NO.	PIPE SECTION	X COORD (M)	Y COORD (M)	Z COORD (M)	HORIZ ANGLE (DEG)	VERT ANGLE (DEG)	PIPE LENGTH (M)	TENSILE STRESS (MPA)	HOOP STRESS (MPA)	BENDING STRESSES VERT (MPA)	HORIZ (MPA)	TOTAL STRESS (MPA)	PERCENT YIELD (PCT)
1	TENSIONR	77.79	6.21	.00	.000	.259	.000	13.44	.00	.00	.00	64.44	17.90
3	LAYBARGE	71.49	6.17	.00	.000	.716	6.300	13.43	.00	-87.79	-.01	152.22	42.28
5	LAYBARGE	65.37	6.04	.00	.000	1.662	12.416	13.41	.00	-63.24	.00	127.65	35.46
7	LAYBARGE	59.91	5.84	.00	.000	2.479	17.883	13.38	.00	-72.41	.00	136.79	38.00
9	LAYBARGE	53.32	5.51	.00	.000	3.354	24.482	13.33	.00	-69.67	.00	134.00	37.22
11	LAYBARGE	47.32	5.11	.00	.000	4.352	30.493	13.26	.00	-88.38	.00	152.65	42.40
13	LAYBARGE	38.21	4.33	.00	.000	5.557	39.635	13.14	.00	-108.83	-.01	172.97	48.05
15	LAYBARGE	29.27	3.35	.00	.000	6.768	48.632	13.99	.00	-87.47	.04	151.46	42.07
17	LAYBARGE	23.13	2.57	.00	-.001	7.770	54.820	13.87	.00	-70.28	-.23	134.15	37.26
19	LAYBARGE	17.18	1.71	.00	.005	8.523	60.832	13.73	.00	-55.09	1.07	118.83	33.01
21	LAYBARGE	10.63	.66	.00	-.026	9.984	67.470	13.55	.00	-159.84	-4.93	223.46	62.07
24	STINGER	-5.62	-2.43	.00	.022	11.714	84.008	13.12	-.16	-180.90	-5.64	244.19	67.83
26	STINGER	-12.12	-3.91	.00	-.005	13.569	90.675	13.96	-.26	-69.53	-.96	132.63	36.84
28	STINGER	-18.58	-5.53	.00	.005	14.716	97.342	13.75	-.37	-92.08	-1.01	155.03	43.06
30	STINGER	-25.01	-7.30	.00	-.021	16.035	104.009	13.52	-.49	-90.83	-5.38	153.75	42.71
32	STINGER	-31.40	-9.21	.00	.099	17.209	110.676	13.28	-.61	-73.75	16.48	138.15	38.38
34	STINGER	-37.74	-11.26	.00	-.475	18.929	117.343	13.99	-.75	-158.23	-88.51	243.67	67.69
36	SAGEBEND	-49.03	-15.32	.22	-1.225	19.696	129.343	13.50	-1.02	15.93	-.10	77.95	21.65
37	SAGEBEND	-60.36	-19.29	.45	-1.094	18.809	141.343	13.99	-1.28	24.26	3.88	86.20	23.95
38	SAGEBEND	-71.75	-23.06	.65	-.929	17.834	153.343	13.51	-1.54	24.91	3.95	86.51	24.03
39	SAGEBEND	-83.20	-26.63	.82	-.767	16.844	165.343	13.05	-1.77	25.21	3.85	86.45	24.01
40	SAGEBEND	-94.72	-30.01	.96	-.611	15.844	177.344	13.61	-2.00	25.47	3.71	86.37	23.99
41	SAGEBEND	-106.29	-33.19	1.07	-.462	14.834	189.344	13.21	-2.21	25.72	3.57	86.30	23.97
42	SAGEBEND	-117.91	-36.15	1.14	-.318	13.813	201.344	13.83	-2.41	25.96	3.44	86.24	23.96
43	SAGEBEND	-129.59	-38.92	1.19	-.181	12.784	213.344	13.47	-2.59	26.18	3.30	86.19	23.94

44	SAGEBEND	-141.32	-41.46	1.22	-.051	11.746	225.344	13.14	-2.76	26.39	3.14	86.13	23.93
45	SAGEBEND	-153.09	-43.80	1.22	.072	10.701	237.344	13.84	-2.92	26.58	2.95	86.09	23.91
46	SAGEBEND	-164.90	-45.92	1.19	.187	9.648	249.344	13.57	-3.06	26.76	2.75	86.04	23.90
47	SAGEBEND	-176.75	-47.82	1.14	.293	8.588	261.344	13.33	-3.18	26.92	2.56	86.01	23.89
48	SAGEBEND	-188.63	-49.50	1.07	.391	7.522	273.345	13.11	-3.30	27.06	2.36	85.97	23.88
49	SAGEBEND	-200.54	-50.96	.98	.481	6.452	285.345	13.93	-3.39	27.19	2.16	85.94	23.87
50	SAGEBEND	-212.48	-52.20	.87	.563	5.376	297.345	13.77	-3.48	27.29	1.99	85.92	23.87
51	SAGEBEND	-224.43	-53.21	.74	.640	4.297	309.345	13.64	-3.54	27.38	1.92	85.91	23.86
52	SAGEBEND	-236.41	-54.00	.60	.715	3.215	321.345	13.54	-3.60	27.45	1.91	85.90	23.86
53	SAGEBEND	-248.39	-54.56	.44	.791	2.130	333.346	13.46	-3.63	27.46	1.88	85.87	23.85
54	SAGEBEND	-260.39	-54.89	.27	.860	1.051	345.346	13.42	-3.65	26.86	1.32	85.20	23.67
55	SEABED	-272.38	-55.00	.09	.814	.101	357.346	13.41	-3.66	13.92	-10.52	75.76	21.04
56	SEABED	-284.38	-55.01	.00	.050	.004	369.346	13.41	-3.66	.47	-9.03	67.36	18.71
57	SEABED	-296.38	-55.01	.00	.003	.000	381.346	13.41	-3.66	.02	-.31	58.63	16.29
58	SEABED	-308.38	-55.01	.00	.000	.000	393.346	13.41	-3.66	.00	-.01	58.33	16.20
59	SEABED	-320.38	-55.01	.00	.000	.000	405.346	13.41	-3.66	.00	.00	58.32	16.20
60	SEABED	-332.38	-55.01	.00	.000	.000	417.346	13.41	-3.66	.00	.00	58.32	16.20
61	SEABED	-344.38	-55.01	.00	.000	.000	429.346	13.41	-3.66	.00	.00	58.32	16.20

STATIC PIPE COORDINATES, FORCES AND STRESSES

NODE NO.	PIPE SECTION	X	Y	Z	HORIZ	VERT	PIPE	TENSILE	HOOP	BENDING STRESSES		TOTAL	PERCNT
		COORD	COORD	COORD	ANGLE	ANGLE	LENGTH	STRESS	STRESS	VERT	HORIZ	STRESS	YIELD
		(M)	(M)	(M)	(DEG)	(DEG)	(M)	(MPA)	(MPA)	(MPA)	(MPA)	(MPA)	(PCT)
62	SEABED	-356.38	-55.01	.00	.000	.000	441.346	56.41	-3.66	.00	.00	58.32	16.20
63	SEABED	-368.38	-55.01	.00	.000	.000	453.346	56.41	-3.66	.00	.00	58.32	16.20

STATIC PIPE COORDINATES, FORCES AND STRESSES

NODE NO.	PIPE SECTION	X	Y	Z	SUPPORT REACTION		SUPT SEPARATIONS		PIPE TENSION	BENDING MOMENTS		
		COORD (M)	COORD (M)	COORD (M)	VERT (KN)	HORIZ (KN)	VERT (M)	HORIZ (M)	(KN)	VERT (KN-M)	HORIZ (KN-M)	TOTAL (KN-M)
1	TENSIONR	77.79	6.21	.00	.55	.00	.00	.00	400.02	.00	.00	.00
3	LAYBARGE	71.49	6.17	.00	16.25	.00	.00	.00	399.93	-19.73	.00	19.73
5	LAYBARGE	65.37	6.04	.00	10.17	.00	.00	.00	399.83	-14.21	.00	14.21
7	LAYBARGE	59.91	5.84	.00	12.39	.00	.00	.00	399.63	-16.27	.00	16.27
9	LAYBARGE	53.32	5.51	.00	11.65	.00	.00	.00	399.30	-15.65	.00	15.65
11	LAYBARGE	47.32	5.11	.00	15.13	.00	.00	.00	398.89	-19.86	.00	19.86
13	LAYBARGE	38.21	4.33	.00	18.88	.00	.00	.00	398.11	-24.45	.00	24.45
15	LAYBARGE	29.27	3.35	.00	15.00	.01	.00	.00	397.18	-19.65	.01	19.65
17	LAYBARGE	23.13	2.57	.00	11.89	-.06	.00	.00	396.43	-15.79	-.05	15.79
19	LAYBARGE	17.18	1.71	.00	8.25	.25	.00	.00	395.61	-12.38	.24	12.38
21	LAYBARGE	10.63	.66	.00	23.57	-.86	.00	.00	394.44	-35.91	-1.11	35.93
24	STINGER	-5.62	-2.43	.00	25.29	-1.16	.00	.00	392.37	-40.65	-1.27	40.67
26	STINGER	-12.12	-3.91	.00	7.91	-.51	.00	.00	391.69	-15.62	-.22	15.62
28	STINGER	-18.58	-5.53	.00	13.18	-.51	.00	.00	390.74	-20.69	-.23	20.69
30	STINGER	-25.01	-7.30	.00	12.87	-1.54	.00	.00	389.73	-20.41	-1.21	20.44
32	STINGER	-31.40	-9.21	.00	8.84	3.59	.00	.00	388.65	-16.57	3.70	16.98
34	STINGER	-37.74	-11.26	.00	23.70	-13.06	.00	.00	387.30	-35.55	-19.89	40.74
36	SAGEBEND	-49.03	-15.32	.22	.00	.00	.00	.00	385.16	3.58	-.02	3.58
37	SAGEBEND	-60.36	-19.29	.45	.00	.00	.00	.00	382.89	5.45	.87	5.52
38	SAGEBEND	-71.75	-23.06	.65	.00	.00	.00	.00	380.73	5.60	.89	5.67
39	SAGEBEND	-83.20	-26.63	.82	.00	.00	.00	.00	378.68	5.66	.87	5.73
40	SAGEBEND	-94.72	-30.01	.96	.00	.00	.00	.00	376.74	5.72	.83	5.78
41	SAGEBEND	-106.29	-33.19	1.07	.00	.00	.00	.00	374.92	5.78	.80	5.83
42	SAGEBEND	-117.91	-36.15	1.14	.00	.00	.00	.00	373.22	5.83	.77	5.88

43	SAGEBND	-129.59	-38.92	1.19	.00	.00	.00	.00	371.64	5.88	.74	5.93
44	SAGEBND	-141.32	-41.46	1.22	.00	.00	.00	.00	370.18	5.93	.70	5.97
45	SAGEBND	-153.09	-43.80	1.22	.00	.00	.00	.00	368.84	5.97	.66	6.01
46	SAGEBND	-164.90	-45.92	1.19	.00	.00	.00	.00	367.63	6.01	.62	6.04
47	SAGEBND	-176.75	-47.82	1.14	.00	.00	.00	.00	366.54	6.05	.58	6.08
48	SAGEBND	-188.63	-49.50	1.07	.00	.00	.00	.00	365.57	6.08	.53	6.10
49	SAGEBND	-200.54	-50.96	.98	.00	.00	.00	.00	364.74	6.11	.48	6.13
50	SAGEBND	-212.48	-52.20	.87	.00	.00	.00	.00	364.03	6.13	.45	6.15
51	SAGEBND	-224.43	-53.21	.74	.00	.00	.00	.00	363.45	6.15	.43	6.17
52	SAGEBND	-236.41	-54.00	.60	.00	.00	.00	.00	363.00	6.17	.43	6.18
53	SAGEBND	-248.39	-54.56	.44	.00	.00	.00	.00	362.68	6.17	.42	6.19
54	SAGEBND	-260.39	-54.89	.27	.00	.00	.00	.00	362.49	6.04	.30	6.04
55	SEABED	-272.38	-55.00	.09	3.53	-3.36	.00	.00	362.43	3.13	-2.36	3.92
56	SEABED	-284.38	-55.01	.00	7.04	-2.72	.00	.00	362.42	.11	-2.03	2.03
57	SEABED	-296.38	-55.01	.00	6.88	.13	.00	.00	362.42	.00	-.07	.07
58	SEABED	-308.38	-55.01	.00	6.88	.00	.00	.00	362.42	.00	.00	.00
59	SEABED	-320.38	-55.01	.00	6.88	.00	.00	.00	362.42	.00	.00	.00
60	SEABED	-332.38	-55.01	.00	6.88	.00	.00	.00	362.42	.00	.00	.00
61	SEABED	-344.38	-55.01	.00	6.88	.00	.00	.00	362.42	.00	.00	.00

STATIC PIPE COORDINATES, FORCES AND STRESSES

NODE NO.	PIPE SECTION	X	Y	Z	SUPPORT REACTION		SUPT SEPARATIONS		PIPE TENSION	BENDING MOMENTS		
		COORD (M)	COORD (M)	COORD (M)	VERT (KN)	HORIZ (KN)	VERT (M)	HORIZ (M)	(KN)	VERT (KN-M)	HORIZ (KN-M)	TOTAL (KN-M)
62	SEABED	-356.38	-55.01	.00	6.88	.00	.00	.00	362.42	.00	.00	.00
63	SEABED	-368.38	-55.01	.00	.00	.00	.00	.00	362.42	.00	.00	.00

STATIC SOLUTION SUMMARY

PIPE PROPERTIES (1)

PIPE SECTION LENGTH ..	12.00 M	ELASTIC MODULUS	207000. MPA
OUTSIDE DIAMETER	16.827 CM	CROSS SECTIONAL AREA .	278.27 CM2
WALL THICKNESS	1.270 CM	MOMENT OF INERTIA	1890.46 CM4
WEIGHT/LENGTH IN AIR .	976.987 N/M	YIELD STRESS	360.00 MPA
SUBMERGED WGT/LENG ..	572.993 N/M	STRESS INTENS FACTOR .	1.000
SPECIFIC GRAVITY	2.418	STEEL DENSITY	76982.0 N/M3
WRAP COAT THICKNESS ..	.400 CM	WRAP COAT DENSITY	12567.0 N/M3
CONCRETE THICKNESS ...	2.500 CM	CONCRETE DENSITY	29856.0 N/M3

BARGE DATA

TOTAL PIPE TENSION ...	400.02 KN	RADIUS OF CURVATURE ..	400.00 M
NUMBER OF TENSIONERS .	1	BARGE TRIM ANGLE000 DEG
NO. OF PIPE SUPPORTS .	10	PIPE ANGLE AT STERN ..	9.984 DEG
BARGE HEADING000 DEG	OFFSET FROM R.O.W.00 M

STINGER DATA

NO. OF PIPE SUPPORTS .	6	STINGER STERN DEPTH ..	-11.26 M
NO. STINGER SECTIONS .	6	PIPE ANGLE AT STERN ..	18.929 DEG
RADIUS OF CURVATURE ..	300.00 M	STINGER LENGTH	41.61 M

SAGEBEND DATA

WATER DEPTH	55.00 M	HORIZ PIPE TENSION ...	362.42 KN
TOUCHDOWN X-COORD. ...	-271.12 M	BOTTOM SLOPE ANGLE000 DEG

SOLUTION SUMMARY

NODE	PIPE	X	Y	Z	SUPPORT	REACT	TOTAL	TOTAL	PCT
NO.	SECTION	COORD	COORD	COORD	VERT	HORIZ	MOMENT	STRESS	YLD

1	TENSIONR	77.8	6.2	.0	.6	.0	.0	64.4	18.
3	LAYBARGE	71.5	6.2	.0	16.3	.0	19.7	152.2	42.
5	LAYBARGE	65.4	6.0	.0	10.2	.0	14.2	127.7	35.
7	LAYBARGE	59.9	5.8	.0	12.4	.0	16.3	136.8	38.
9	LAYBARGE	53.3	5.5	.0	11.7	.0	15.7	134.0	37.
11	LAYBARGE	47.3	5.1	.0	15.1	.0	19.9	152.6	42.
13	LAYBARGE	38.2	4.3	.0	18.9	.0	24.5	173.0	48.
15	LAYBARGE	29.3	3.4	.0	15.0	.0	19.7	151.5	42.
17	LAYBARGE	23.1	2.6	.0	11.9	-.1	15.8	134.1	37.
19	LAYBARGE	17.2	1.7	.0	8.3	.3	12.4	118.8	33.
21	LAYBARGE	10.6	.7	.0	23.6	-.9	35.9	223.5	62.
24	STINGER	-5.6	-2.4	.0	25.3	-1.2	40.7	244.2	68.
26	STINGER	-12.1	-3.9	.0	7.9	-.5	15.6	132.6	37.
28	STINGER	-18.6	-5.5	.0	13.2	-.5	20.7	155.0	43.
30	STINGER	-25.0	-7.3	.0	12.9	-1.5	20.4	153.8	43.
32	STINGER	-31.4	-9.2	.0	8.8	3.6	17.0	138.2	38.

OFFPIPE - OFFSHORE PIPELINE ANALYSIS SYSTEM - VERSION 2.05 AC PAGE 108

JOB NO. - TUGAS AKHIR LICENSED TO: RICKY TAMEKAL

USER ID - IDA BAGUS FUNDHARA S DATE - 5/ 6/2020 TIME - 21: 6:22 CASE 8

STATIC SOLUTION SUMMARY

34	STINGER	-37.7	-11.3	.0	23.7	-13.1	40.7	243.7	68.
38	SAGEBEND	-71.7	-23.1	.6	.0	.0	5.7	86.5	24.
55	SEABED	-272.4	-55.0	.1	3.5	-3.4	3.9	75.8	21.

STATIC PIPE COORDINATES, FORCES AND STRESSES

NODE NO.	PIPE SECTION	X COORD (M)	Y COORD (M)	Z COORD (M)	HORIZ ANGLE (DEG)	VERT ANGLE (DEG)	PIPE LENGTH (M)	TENSILE STRESS (MPA)	HOOP STRESS (MPA)	BENDING STRESSES VERT (MPA)	HORIZ (MPA)	TOTAL STRESS (MPA)	PERCENT YIELD (PCT)
1	TENSIONR	77.79	6.21	.00	.000	.259	.000	13.45	.00	.00	.00	64.45	17.90
3	LAYBARGE	71.49	6.17	.00	.000	.716	6.300	13.44	.00	-87.79	-.01	152.23	42.29
5	LAYBARGE	65.37	6.04	.00	.000	1.662	12.416	13.42	.00	-63.24	.00	127.66	35.46
7	LAYBARGE	59.91	5.84	.00	.000	2.479	17.883	13.39	.00	-72.41	.00	136.80	38.00
9	LAYBARGE	53.32	5.51	.00	.000	3.354	24.482	13.33	.00	-69.67	.00	134.01	37.22
11	LAYBARGE	47.32	5.11	.00	.000	4.352	30.493	13.27	.00	-88.39	.00	152.66	42.40
13	LAYBARGE	38.21	4.33	.00	.000	5.557	39.635	13.14	.00	-108.83	-.01	172.97	48.05
15	LAYBARGE	29.27	3.35	.00	.000	6.768	48.632	13.99	.00	-87.49	.04	151.48	42.08
17	LAYBARGE	23.13	2.57	.00	-.001	7.769	54.820	13.87	.00	-70.20	-.23	134.08	37.24
19	LAYBARGE	17.18	1.71	.00	.005	8.525	60.832	13.74	.00	-55.45	1.07	119.20	33.11
21	LAYBARGE	10.63	.66	.00	-.026	9.975	67.470	13.55	.00	-158.18	-4.91	221.81	61.61
24	STINGER	-5.62	-2.41	.00	.021	11.473	84.004	13.14	-.16	-154.53	-5.72	217.85	60.51
26	STINGER	-12.13	-3.85	.00	-.003	12.969	90.671	13.98	-.26	-51.02	-.48	114.13	31.70
28	STINGER	-18.62	-5.39	.00	-.007	13.806	97.338	13.78	-.36	-71.95	-3.35	134.98	37.50
30	STINGER	-25.08	-7.03	.00	.039	14.805	104.005	13.56	-.47	-71.11	5.78	134.14	37.26
32	STINGER	-31.51	-8.78	-.01	.103	15.498	110.672	13.34	-.58	-33.51	-1.33	96.17	26.71
34	STINGER	-37.91	-10.65	.00	-.559	17.873	117.339	13.02	-.71	-280.40	-82.38	290.63	80.51
36	SAGEBEND	-49.21	-14.68	.22	-1.243	19.794	129.339	13.58	-.98	10.25	.21	72.33	20.09
37	SAGEBEND	-60.52	-18.67	.46	-1.108	18.962	141.339	13.07	-1.24	23.95	3.92	85.96	23.88
38	SAGEBEND	-71.90	-22.47	.66	-.941	17.991	153.339	13.58	-1.50	24.86	3.97	86.51	24.03
39	SAGEBEND	-83.35	-26.08	.83	-.779	17.003	165.339	13.12	-1.74	25.16	3.87	86.46	24.02
40	SAGEBEND	-94.85	-29.49	.97	-.621	16.005	177.339	13.68	-1.96	25.43	3.74	86.38	23.99
41	SAGEBEND	-106.41	-32.69	1.08	-.471	14.996	189.339	13.27	-2.18	25.68	3.59	86.31	23.98
42	SAGEBEND	-118.03	-35.69	1.16	-.327	13.977	201.339	13.88	-2.38	25.92	3.46	86.25	23.96
43	SAGEBEND	-129.70	-38.49	1.22	-.189	12.949	213.339	13.52	-2.56	26.15	3.32	86.19	23.94

44	SAGEBEND	-141.42	-41.07	1.24	-.057	11.913	225.339	13.19	-2.73	26.36	3.16	86.14	23.93
45	SAGEBEND	-153.19	-43.44	1.24	.067	10.868	237.339	13.89	-2.89	26.56	2.98	86.09	23.91
46	SAGEBEND	-164.99	-45.60	1.21	.183	9.816	249.340	13.61	-3.04	26.74	2.78	86.05	23.90
47	SAGEBEND	-176.83	-47.53	1.17	.290	8.758	261.340	13.36	-3.16	26.90	2.60	86.01	23.89
48	SAGEBEND	-188.71	-49.25	1.09	.390	7.693	273.340	13.14	-3.28	27.04	2.39	85.98	23.88
49	SAGEBEND	-200.62	-50.75	1.00	.481	6.623	285.340	13.95	-3.38	27.17	2.19	85.95	23.87
50	SAGEBEND	-212.55	-52.02	.89	.565	5.548	297.340	13.79	-3.46	27.28	2.02	85.92	23.87
51	SAGEBEND	-224.50	-53.07	.77	.642	4.469	309.340	13.65	-3.53	27.37	1.93	85.91	23.86
52	SAGEBEND	-236.47	-53.89	.63	.718	3.387	321.341	13.55	-3.59	27.44	1.91	85.90	23.86
53	SAGEBEND	-248.46	-54.48	.47	.793	2.303	333.341	13.47	-3.63	27.47	1.89	85.88	23.86
54	SAGEBEND	-260.45	-54.85	.30	.865	1.221	345.341	13.42	-3.65	27.16	1.51	85.52	23.75
55	SAGEBEND	-272.45	-55.00	.11	.858	.208	357.342	13.41	-3.66	20.01	-6.46	79.33	22.04
56	SEABED	-284.45	-55.01	.00	.098	.004	369.342	13.41	-3.66	.64	-14.21	72.53	20.15
57	SEABED	-296.45	-55.01	.00	.004	.000	381.342	13.41	-3.66	.02	-.48	58.80	16.33
58	SEABED	-308.45	-55.01	.00	.000	.000	393.342	13.41	-3.66	.00	-.02	58.34	16.21
59	SEABED	-320.45	-55.01	.00	.000	.000	405.342	13.41	-3.66	.00	.00	58.32	16.20
60	SEABED	-332.45	-55.01	.00	.000	.000	417.342	13.41	-3.66	.00	.00	58.32	16.20
61	SEABED	-344.45	-55.01	.00	.000	.000	429.342	13.41	-3.66	.00	.00	58.32	16.20

OFFPIPE - OFFSHORE PIPELINE ANALYSIS SYSTEM - VERSION 2.05 AC DATE - 5/ 6/2020 TIME - 21: 6:22 PAGE 106
PROJECT - TUGAS AKHIR JOB NO. - ANALISIS STATIS
USER ID - IIDA BAGUS FUNDHARA SAKYANARY LICENSED TO: RICKY TAMEKAL CASE 9

STATIC PIPE COORDINATES, FORCES AND STRESSES

NODE NO.	PIPE SECTION	X	Y	Z	HORIZ	VERT	PIPE	TENSILE	HOOP	BENDING STRESSES		TOTAL	PERCNT
		COORD (M)	COORD (M)	COORD (M)	ANGLE (DEG)	ANGLE (DEG)	LENGIH (M)	STRESS (MPA)	STRESS (MPA)	VERT (MPA)	HORIZ (MPA)	STRESS (MPA)	YIELD (PCT)
62	SEABED	-356.45	-55.01	.00	.000	.000	441.342	56.41	-3.66	.00	.00	58.32	16.20
63	SEABED	-368.45	-55.01	.00	.000	.000	453.342	56.41	-3.66	.00	.00	58.32	16.20

OFFPIPE - OFFSHORE PIPELINE ANALYSIS SYSTEM - VERSION 2.05 AC DATE - 5/ 6/2020 TIME - 21: 6:22 PAGE 106
PROJECT - TUGAS AKHIR JOB NO. - ANALISIS STATIS
USER ID - IIDA BAGUS FUNDHARA SAKYANARY LICENSED TO: RICKY TAMEKAL CASE 9

STATIC PIPE COORDINATES, FORCES AND STRESSES

NODE NO.	PIPE SECTION	X	Y	Z	SUPPORT REACTION		SUPT SEPARATIONS		PIPE	BENDING MOMENTS		
		COORD (M)	COORD (M)	COORD (M)	VERT (KN)	HORIZ (KN)	VERT (M)	HORIZ (M)	TENSION (KN)	VERT (KN-M)	HORIZ (KN-M)	TOTAL (KN-M)
1	TENSIONR	77.79	6.21	.00	.55	.00	.00	.00	400.05	.00	.00	.00
3	LAYBARGE	71.49	6.17	.00	16.25	.00	.00	.00	399.96	-19.73	.00	19.73
5	LAYBARGE	65.37	6.04	.00	10.17	.00	.00	.00	399.86	-14.21	.00	14.21
7	LAYBARGE	59.91	5.84	.00	12.39	.00	.00	.00	399.66	-16.27	.00	16.27
9	LAYBARGE	53.32	5.51	.00	11.65	.00	.00	.00	399.33	-15.65	.00	15.65
11	LAYBARGE	47.32	5.11	.00	15.13	.00	.00	.00	398.92	-19.86	.00	19.86
13	LAYBARGE	38.21	4.33	.00	18.88	.00	.00	.00	398.13	-24.45	.00	24.45
15	LAYBARGE	29.27	3.35	.00	15.00	.01	.00	.00	397.21	-19.66	.01	19.66
17	LAYBARGE	23.13	2.57	.00	11.88	-.06	.00	.00	396.46	-15.77	-.05	15.77
19	LAYBARGE	17.18	1.71	.00	8.34	.25	.00	.00	395.64	-12.46	.24	12.46
21	LAYBARGE	10.63	.66	.00	23.52	-.85	.00	.00	394.47	-35.54	-1.10	35.56

24	STINGER	-5.62	-2.41	.00	22.05	-1.18	.00	.00	392.45	-34.72	-1.28	34.74
26	STINGER	-12.13	-3.85	.00	6.06	-.39	.00	.00	391.76	-11.46	-.11	11.46
28	STINGER	-18.62	-5.39	.00	10.96	-1.06	.00	.00	390.86	-16.17	-.75	16.18
30	STINGER	-25.08	-7.03	.00	11.11	.44	.00	.00	389.92	-15.98	1.30	16.03
32	STINGER	-31.51	-8.78	-.01	1.19	.69	.01	-.01	388.94	-7.53	-.30	7.54
34	STINGER	-37.91	-10.65	.00	41.46	-11.84	.00	.00	387.34	-63.00	-18.51	65.67
36	SAGEBEND	-49.21	-14.68	.22	.00	.00	.00	.00	385.52	2.30	.05	2.30
37	SAGEBEND	-60.52	-18.67	.46	.00	.00	.00	.00	383.23	5.38	.88	5.45
38	SAGEBEND	-71.90	-22.47	.66	.00	.00	.00	.00	381.05	5.59	.89	5.66
39	SAGEBEND	-83.35	-26.08	.83	.00	.00	.00	.00	378.98	5.65	.87	5.72
40	SAGEBEND	-94.85	-29.49	.97	.00	.00	.00	.00	377.03	5.71	.84	5.78
41	SAGEBEND	-106.41	-32.69	1.08	.00	.00	.00	.00	375.19	5.77	.81	5.83
42	SAGEBEND	-118.03	-35.69	1.16	.00	.00	.00	.00	373.47	5.82	.78	5.88
43	SAGEBEND	-129.70	-38.49	1.22	.00	.00	.00	.00	371.87	5.88	.75	5.92
44	SAGEBEND	-141.42	-41.07	1.24	.00	.00	.00	.00	370.39	5.92	.71	5.97
45	SAGEBEND	-153.19	-43.44	1.24	.00	.00	.00	.00	369.03	5.97	.67	6.00
46	SAGEBEND	-164.99	-45.60	1.21	.00	.00	.00	.00	367.80	6.01	.63	6.04
47	SAGEBEND	-176.83	-47.53	1.17	.00	.00	.00	.00	366.69	6.04	.58	6.07
48	SAGEBEND	-188.71	-49.25	1.09	.00	.00	.00	.00	365.70	6.08	.54	6.10
49	SAGEBEND	-200.62	-50.75	1.00	.00	.00	.00	.00	364.85	6.10	.49	6.12
50	SAGEBEND	-212.55	-52.02	.89	.00	.00	.00	.00	364.12	6.13	.45	6.15
51	SAGEBEND	-224.50	-53.07	.77	.00	.00	.00	.00	363.52	6.15	.43	6.16
52	SAGEBEND	-236.47	-53.89	.63	.00	.00	.00	.00	363.05	6.16	.43	6.18
53	SAGEBEND	-248.46	-54.48	.47	.00	.00	.00	.00	362.70	6.17	.42	6.19
54	SAGEBEND	-260.45	-54.85	.30	.00	.00	.00	.00	362.49	6.10	.34	6.11
55	SAGEBEND	-272.45	-55.00	.11	2.43	-2.47	.00	.00	362.41	4.50	-1.45	4.73
56	SEABED	-284.45	-55.01	.00	7.05	-3.69	.00	.00	362.42	.14	-3.19	3.19
57	SEABED	-296.45	-55.01	.00	6.88	.18	.00	.00	362.42	.00	-.11	.11
58	SEABED	-308.45	-55.01	.00	6.88	.01	.00	.00	362.42	.00	.00	.00
59	SEABED	-320.45	-55.01	.00	6.88	.00	.00	.00	362.42	.00	.00	.00
60	SEABED	-332.45	-55.01	.00	6.88	.00	.00	.00	362.42	.00	.00	.00
61	SEABED	-344.45	-55.01	.00	6.88	.00	.00	.00	362.42	.00	.00	.00

STATIC PIPE COORDINATES, FORCES AND STRESSES

NODE NO.	PIPE SECTION	X	Y	Z	SUPPORT REACTION		SUPT SEPARATIONS		PIPE TENSION	BENDING MOMENTS		
		COORD (M)	COORD (M)	COORD (M)	VERT (KN)	HORIZ (KN)	VERT (M)	HORIZ (M)	(KN)	VERT (KN-M)	HORIZ (KN-M)	TOTAL (KN-M)
62	SEABED	-356.45	-55.01	.00	6.88	.00	.00	.00	362.42	.00	.00	.00
63	SEABED	-368.45	-55.01	.00	.00	.00	.00	.00	362.42	.00	.00	.00

STATIC SOLUTION SUMMARY

PIPE PROPERTIES (1)

PIPE SECTION LENGTH ..	12.00 M	ELASTIC MODULUS	207000. MPA
OUTSIDE DIAMETER	16.827 CM	CROSS SECTIONAL AREA .	278.27 CM2
WALL THICKNESS	1.270 CM	MOMENT OF INERTIA	1890.46 CM4
WEIGHT/LENGTH IN AIR .	976.987 N/M	YIELD STRESS	360.00 MPA
SUBMERGED WGH/LENG ..	572.993 N/M	STRESS INTENS FACTOR .	1.000
SPECIFIC GRAVITY	2.418	STEEL DENSITY	76982.0 N/M3
WRAP COAT THICKNESS ..	.400 CM	WRAP COAT DENSITY	12567.0 N/M3
CONCRETE THICKNESS ...	2.500 CM	CONCRETE DENSITY	29856.0 N/M3

BARGE DATA

TOTAL PIPE TENSION ...	400.05 KN	RADIUS OF CURVATURE ..	400.00 M
NUMBER OF TENSIONERS .	1	BARGE TRIM ANGLE000 DEG
NO. OF PIPE SUPPORTS .	10	PIPE ANGLE AT STERN ..	9.975 DEG
BARGE HEADING000 DEG	OFFSET FROM R.O.W.00 M

STINGER DATA

NO. OF PIPE SUPPORTS .	6	STINGER STERN DEPTH ..	-10.65 M
NO. STINGER SECTIONS .	6	PIPE ANGLE AT STERN ..	17.873 DEG
RADIUS OF CURVATURE ..	400.00 M	STINGER LENGH	41.60 M

SAGEEND DATA

WATER DEPTH	55.00 M	HORIZ PIPE TENSION ...	362.42 KN
TOUCHDOWN X-COORD. ...	-273.20 M	BOITOM SLOPE ANGLE000 DEG

SOLUTION SUMMARY

NO.	PIPE	X	Y	Z	SUPPORT	REACT	TOTAL	TOTAL	PCT
NO.	SECTION	COORD	COORD	COORD	VERT	HORIZ	MOMENT	STRESS	YLD
1	TENSIONR	77.8	6.2	.0	.6	.0	.0	64.4	18.

3	LAYBARGE	71.5	6.2	.0	16.3	.0	19.7	152.2	42.
5	LAYBARGE	65.4	6.0	.0	10.2	.0	14.2	127.7	35.
7	LAYBARGE	59.9	5.8	.0	12.4	.0	16.3	136.8	38.
9	LAYBARGE	53.3	5.5	.0	11.7	.0	15.7	134.0	37.
11	LAYBARGE	47.3	5.1	.0	15.1	.0	19.9	152.7	42.
13	LAYBARGE	38.2	4.3	.0	18.9	.0	24.5	173.0	48.
15	LAYBARGE	29.3	3.4	.0	15.0	.0	19.7	151.5	42.
17	LAYBARGE	23.1	2.6	.0	11.9	-.1	15.8	134.1	37.
19	LAYBARGE	17.2	1.7	.0	8.3	.3	12.5	119.2	33.
21	LAYBARGE	10.6	.7	.0	23.5	-.9	35.6	221.8	62.
24	STINGER	-5.6	-2.4	.0	22.1	-1.2	34.7	217.9	61.
26	STINGER	-12.1	-3.8	.0	6.1	-.4	11.5	114.1	32.
28	STINGER	-18.6	-5.4	.0	11.0	-1.1	16.2	135.0	37.
30	STINGER	-25.1	-7.0	.0	11.1	.4	16.0	134.1	37.
32	STINGER	-31.5	-8.8	.0	1.2	.7	7.5	96.2	27.

OFFPIPE - OFFSHORE PIPELINE ANALYSIS SYSTEM - VERSION 2.05 AC PAGE 108

JOB NO. - TUGAS AKHIR LICENSED TO: RICKY TAMEKAL

USER ID - IDA BAGUS PUNDHARA S DATE - 5/ 6/2020 TIME - 21: 6:22 CASE 9

STATIC SOLUTION SUMMARY

34	STINGER	-37.9	-10.7	.0	41.5	-11.8	65.7	354.6	99.
38	SAGEBEND	-71.9	-22.5	.7	.0	.0	5.7	86.5	24.
56	SEABED	-284	-550	0	71	-37	32	725	20

OUTPUT REGANGAN STATIS

SOLUTION SUMMARY									
NODE	PIPE	X	Y	Z	SUPPORT	REACT	TOTAL	TOTAL	PCT
NO.	SECTION	COORD	COORD	COORD	VERT	HORIZ	MOMENT	STRAIN	ALL
		(M)	(M)	(M)	(KN)	(KN)	(KN-M)	(PCT)	(%)
1	TENSIONR	77.8	6.2	0.0	-2.5	0.0	0.0	0.012	0.
3	LAVARGE	71.5	6.2	0.0	23.4	0.0	46.9	0.047	0.
5	LAVARGE	65.4	6.0	0.0	10.0	0.0	33.8	0.077	0.
7	LAVARGE	59.9	5.7	0.0	14.5	0.0	38.2	0.043	0.
9	LAVARGE	53.3	5.3	0.0	13.0	0.0	36.8	0.072	0.
11	LAVARGE	47.3	4.7	0.0	17.1	0.0	41.9	0.086	0.
13	LAVARGE	38.2	3.7	0.0	21.4	0.0	47.4	0.052	0.
15	LAVARGE	29.3	2.4	0.0	16.9	0.0	41.5	0.076	0.
17	LAVARGE	23.1	1.3	0.0	13.6	0.0	37.4	0.056	0.
19	LAVARGE	17.2	0.2	0.0	8.3	0.0	32.6	0.053	0.
21	LAVARGE	10.6	-1.2	0.0	20.7	-1.4	54.2	0.080	0.
24	STINGER	-4.6	-5.1	0.0	26.7	-1.2	73.9	0.103	0.
26	STINGER	-11.0	-7.1	0.0	8.7	-1.3	47.9	0.064	0.
28	STINGER	-17.3	-9.3	0.0	15.8	3.3	55.5	0.074	0.
30	STINGER	-23.5	-11.7	0.0	15.4	-6.9	51.9	0.087	0.
32	STINGER	-29.7	-14.2	0.1	7.3	-4.3	25.0	0.077	0.
34	STINGER	-35.8	-16.9	0.2	0.0	0.0	7.6	0.029	0.
46	SAGEEND	-162.8	-51.0	0.7	0.0	0.0	23.2	0.073	0.
50	SEARHD	-210.7	-53.0	0.0	7.8	-3.8	8.9	0.056	0.

SOLUTION SUMMARY									
NODE	PIPE	X	Y	Z	SUPPORT	REACT	TOTAL	TOTAL	PCT
NO.	SECTION	COORD	COORD	COORD	VERT	HORIZ	MOMENT	STRAIN	ALL
		(M)	(M)	(M)	(KN)	(KN)	(KN-M)	(PCT)	(%)
1	TENSIONR	77.8	6.2	0.0	-2.5	0.0	0.0	0.012	0.
3	LAVARGE	71.5	6.2	0.0	23.4	0.0	46.9	0.046	0.
5	LAVARGE	65.4	6.0	0.0	10.0	0.0	33.8	0.070	0.
7	LAVARGE	59.9	5.7	0.0	14.5	0.0	38.2	0.047	0.
9	LAVARGE	53.3	5.3	0.0	13.0	0.0	36.8	0.079	0.
11	LAVARGE	47.3	4.7	0.0	17.1	0.0	41.9	0.080	0.
13	LAVARGE	38.2	3.7	0.0	21.4	0.0	47.4	0.059	0.
15	LAVARGE	29.3	2.4	0.0	16.8	0.0	41.5	0.076	0.
17	LAVARGE	23.1	1.3	0.0	13.7	0.0	37.5	0.066	0.

19	LAVEARGE	17.2	0.2	0.0	7.8	0.0	32.1	0.057	0.
21	LAVEARGE	10.6	-1.2	0.0	21.9	-1.4	56.1	0.095	0.
24	STINGER	-4.6	-5.1	0.0	21.6	-1.4	56.0	0.087	0.
26	STINGER	-11.0	-7.0	0.0	6.1	-0.3	31.5	0.045	0.
28	STINGER	-17.4	-9.0	0.0	11.4	-0.8	37.1	0.071	0.
30	STINGER	-23.7	-11.2	0.0	11.3	-0.2	37.0	0.081	0.
32	STINGER	-29.9	-13.5	0.0	8.1	1.3	31.6	0.065	0.
34	STINGER	-36.1	-15.9	0.0	16.2	-9.4	44.5	0.080	0.
47	SAGEBD	-174.9	-51.8	0.5	0.0	0.0	23.2	0.053	0.
50	SEABED	-210.9	-53.0	0.1	6.8	-3.8	9.4	0.036	0.

===== SOLUTION SUMMARY =====

3

NODE	PIPE	X	Y	Z	SUPPORT	REACT	TOTAL	TOTAL	PCT
NO.	SECTION	COORD	COORD	COORD	VERT	HORIZ	MOMENT	STRAIN	ALL
		(M)	(M)	(M)	(KN)	(KN)	(KN-M)	(PCT)	(%)

1	TENSIONR	77.8	6.2	0.0	-2.5	0.0	0.0	0.018	0.
3	LAVEARGE	71.5	6.2	0.0	23.4	0.0	46.9	0.070	0.
5	LAVEARGE	65.4	6.0	0.0	10.0	0.0	33.8	0.074	0.
7	LAVEARGE	59.9	5.7	0.0	14.5	0.0	38.2	0.058	0.
9	LAVEARGE	53.3	5.3	0.0	13.0	0.0	36.8	0.063	0.
11	LAVEARGE	47.3	4.7	0.0	17.1	0.0	41.9	0.062	0.
13	LAVEARGE	38.2	3.7	0.0	21.4	0.0	47.4	0.068	0.
15	LAVEARGE	29.3	2.4	0.0	16.8	0.0	41.5	0.074	0.
17	LAVEARGE	23.1	1.3	0.0	13.8	0.0	37.5	0.067	0.
19	LAVEARGE	17.2	0.2	0.0	7.6	0.0	31.8	0.062	0.
21	LAVEARGE	10.6	-1.2	0.0	22.5	-1.4	57.1	0.055	0.
24	STINGER	-4.6	-5.1	0.0	19.1	-1.4	47.1	0.086	0.
26	STINGER	-11.0	-6.9	0.0	4.5	-0.1	23.0	0.074	0.
28	STINGER	-17.4	-8.9	0.0	10.3	-1.9	29.2	0.042	0.
30	STINGER	-23.7	-10.9	0.0	9.1	2.0	27.0	0.079	0.
32	STINGER	-30.0	-13.1	0.0	0.6	0.4	21.7	0.065	0.
34	STINGER	-36.3	-15.4	0.0	31.7	-10.0	78.9	0.115	0.
47	SAGEBD	-175.0	-51.6	0.6	0.0	0.0	23.2	0.043	0.
50	SEABED	-210.9	-53.0	0.1	5.8	-3.4	10.0	0.027	0.

===== SOLUTION SUMMARY =====

4

NODE	PIPE	X	Y	Z	SUPPORT	REACT	TOTAL	TOTAL	PCT
NO.	SECTION	COORD	COORD	COORD	VERT	HORIZ	MOMENT	STRAIN	ALL
		(M)	(M)	(M)	(KN)	(KN)	(KN-M)	(PCT)	(%)

1	TENSION	77.8	6.2	0.0	-2.4	0.0	0.0	0.023	0.
3	LAYERGE	71.5	6.2	0.0	25.7	0.0	48.0	0.086	0.
5	LAYERGE	65.4	6.0	0.0	11.9	0.0	34.7	0.081	0.
7	LAYERGE	59.9	5.7	0.0	16.5	0.0	39.2	0.065	0.
9	LAYERGE	53.3	5.3	0.0	15.0	0.0	37.8	0.071	0.
11	LAYERGE	47.3	4.7	0.0	19.7	0.0	43.6	0.069	0.
13	LAYERGE	38.2	3.7	0.0	24.6	0.0	49.9	0.076	0.
15	LAYERGE	29.3	2.4	0.0	19.4	0.0	43.2	0.083	0.
17	LAYERGE	23.1	1.3	0.0	15.7	0.0	38.4	0.075	0.
19	LAYERGE	17.2	0.2	0.0	9.6	-0.1	32.9	0.069	0.
21	LAYERGE	10.6	-1.2	0.0	25.2	-1.3	59.4	0.092	0.
24	STINGER	-4.6	-5.1	0.0	32.2	-2.3	79.6	0.113	0.
26	STINGER	-11.0	-7.1	0.0	12.3	5.0	50.1	0.083	0.
28	STINGER	-17.3	-9.3	0.0	21.1	-12.2	57.6	0.092	0.
30	STINGER	-23.5	-11.6	0.1	3.0	-1.8	12.7	0.038	0.
32	STINGER	-29.8	-14.0	0.2	0.0	0.0	8.6	0.033	0.
34	STINGER	-36.0	-16.4	0.3	0.0	0.0	13.3	0.038	0.
49	SAGEBD	-199.6	-51.9	0.6	0.0	0.0	16.8	0.041	0.
52	SEABED	-235.5	-53.0	0.1	4.6	-2.8	8.6	0.031	0.

===== SOLUTION SUMMARY =====

NODE	PILE	X	Y	Z	SUPPORT	REACT	TOTAL	TOTAL	PCT
NO.	SECTION	COORD	COORD	COORD	VERT	HORIZ	MOMENT	STRAIN	ALL
		(M)	(M)	(M)	(KN)	(KN)	(KN-M)	(PCT)	(%)

1	TENSION	77.8	6.2	0.0	-2.4	0.0	0.0	0.026	0.
3	LAYERGE	71.5	6.2	0.0	25.7	0.0	48.0	0.084	0.
5	LAYERGE	65.4	6.0	0.0	11.9	0.0	34.7	0.062	0.
7	LAYERGE	59.9	5.7	0.0	16.5	0.0	39.2	0.073	0.
9	LAYERGE	53.3	5.3	0.0	15.0	0.0	37.8	0.064	0.
11	LAYERGE	47.3	4.7	0.0	19.7	0.0	43.6	0.075	0.
13	LAYERGE	38.2	3.7	0.0	24.6	0.0	49.9	0.084	0.
15	LAYERGE	29.3	2.4	0.0	19.4	0.0	43.2	0.073	0.
17	LAYERGE	23.1	1.3	0.0	15.8	0.0	38.5	0.062	0.
19	LAYERGE	17.2	0.2	0.0	9.3	0.0	32.6	0.061	0.
21	LAYERGE	10.6	-1.2	0.0	26.3	-1.4	60.8	0.092	0.
24	STINGER	-4.6	-5.1	0.0	26.0	-1.2	60.7	0.137	0.
26	STINGER	-11.0	-7.0	0.0	7.3	-1.1	31.7	0.063	0.
28	STINGER	-17.4	-9.0	0.0	15.2	2.5	39.9	0.075	0.
30	STINGER	-23.7	-11.2	0.0	11.8	-6.8	35.0	0.062	0.

32	STINGER	-29.9	-13.5	0.1	8.6	-5.0	21.8	0.046	0.
34	STINGER	-36.2	-15.8	0.2	0.0	0.0	7.0	0.037	0.
49	SAGEEND	-199.7	-51.8	0.6	0.0	0.0	16.8	0.042	0.
52	SEAFED	-235.6	-53.0	0.1	3.6	-2.1	9.8	0.033	0.

SOLUTION SUMMARY

NOE	PIPE	X	Y	Z	SUPPORT	REACT	TOTAL	TOTAL	ECT
NO. SECTION		COORD	COORD	COORD	VERT	HORIZ	MOMENT	STRAIN	ALL
		(M)	(M)	(M)	(KN)	(KN)	(KN-M)	(ECT)	(%)

1	TENSIONR	77.8	6.2	0.0	-2.4	0.0	0.0	0.024	0.
3	LAVARGE	71.5	6.2	0.0	25.7	0.0	48.0	0.083	0.
5	LAVARGE	65.4	6.0	0.0	11.9	0.0	34.7	0.066	0.
7	LAVARGE	59.9	5.7	0.0	16.5	0.0	39.2	0.072	0.
9	LAVARGE	53.3	5.3	0.0	15.0	0.0	37.8	0.065	0.
11	LAVARGE	47.3	4.7	0.0	19.7	0.0	43.6	0.077	0.
13	LAVARGE	38.2	3.7	0.0	24.6	0.0	49.9	0.086	0.
15	LAVARGE	29.3	2.4	0.0	19.4	0.0	43.2	0.075	0.
17	LAVARGE	23.1	1.3	0.0	15.8	0.0	38.5	0.062	0.
19	LAVARGE	17.2	0.2	0.0	9.1	0.0	32.4	0.063	0.
21	LAVARGE	10.6	-1.2	0.0	26.8	-1.4	61.5	0.096	0.
24	STINGER	-4.6	-5.1	0.0	22.8	-1.4	51.1	0.083	0.
26	STINGER	-11.0	-6.9	0.0	5.5	-0.3	23.3	0.052	0.
28	STINGER	-17.4	-8.9	0.0	11.8	-0.9	29.9	0.056	0.
30	STINGER	-23.7	-10.9	0.0	11.1	1.2	28.5	0.057	0.
32	STINGER	-30.0	-13.1	0.0	9.1	-5.3	26.1	0.058	0.
34	STINGER	-36.3	-15.3	0.1	9.1	-5.3	20.9	0.045	0.
49	SAGEEND	-199.7	-51.7	0.6	0.0	0.0	16.8	0.043	0.
52	SEAFED	-235.7	-53.0	0.1	2.7	-1.6	11.2	0.035	0.

SOLUTION SUMMARY

NOE	PIPE	X	Y	Z	SUPPORT	REACT	TOTAL	TOTAL	ECT
NO. SECTION		COORD	COORD	COORD	VERT	HORIZ	MOMENT	STRAIN	ALL
		(M)	(M)	(M)	(KN)	(KN)	(KN-M)	(ECT)	(%)

1	TENSIONR	77.8	6.2	0.0	-2.5	0.0	0.0	0.018	0.
3	LAVARGE	71.5	6.2	0.0	23.4	0.0	46.9	0.073	0.
5	LAVARGE	65.4	6.0	0.0	10.0	0.0	33.8	0.056	0.
7	LAVARGE	59.9	5.7	0.0	14.5	0.0	38.2	0.065	0.
9	LAVARGE	53.3	5.3	0.0	13.0	0.0	36.8	0.062	0.
11	LAVARGE	47.3	4.7	0.0	17.1	0.0	41.9	0.065	0.

13	LAVARGE	38.2	3.7	0.0	21.4	0.0	47.4	0.074	0.
15	LAVARGE	29.3	2.4	0.0	16.9	0.0	41.5	0.061	0.
17	LAVARGE	23.1	1.3	0.0	13.6	0.0	37.4	0.063	0.
19	LAVARGE	17.2	0.2	0.0	8.3	0.0	32.6	0.052	0.
21	LAVARGE	10.6	-1.2	0.0	20.7	-1.4	54.2	0.082	0.
24	STINGER	-4.6	-5.1	0.0	26.6	-1.3	73.9	0.104	0.
26	STINGER	-11.0	-7.1	0.0	8.8	-0.7	47.9	0.075	0.
28	STINGER	-17.3	-9.3	0.0	15.5	0.8	55.1	0.082	0.
30	STINGER	-23.5	-11.7	0.0	13.8	-1.2	50.4	0.073	0.
32	STINGER	-29.7	-14.3	0.0	13.8	-8.1	42.9	0.066	0.
34	STINGER	-35.8	-17.0	0.1	0.0	0.0	4.9	0.027	0.
47	SAGEBD	-174.1	-54.5	0.6	0.0	0.0	23.4	0.043	0.
50	SEAFED	-210.0	-56.0	0.1	4.5	-2.7	11.9	0.021	0.

===== SOLUTION SUMMARY =====

NOE	PIE	X	Y	Z	SUPPORT	REACT	TOTAL	TOTAL	ECT
NO.	SECTION	COORD	COORD	COORD	VERT	HORIZ	MOMENT	STRAIN	ALL
		(M)	(M)	(M)	(KN)	(KN)	(KN-M)	(ECT)	(%)

1	TENSIONR	77.8	6.2	0.0	-2.5	0.0	0.0	0.016	0.
3	LAVARGE	71.5	6.2	0.0	23.4	0.0	46.9	0.072	0.
5	LAVARGE	65.4	6.0	0.0	10.0	0.0	33.8	0.057	0.
7	LAVARGE	59.9	5.7	0.0	14.5	0.0	38.2	0.063	0.
9	LAVARGE	53.3	5.3	0.0	13.0	0.0	36.8	0.067	0.
11	LAVARGE	47.3	4.7	0.0	17.1	0.0	41.9	0.066	0.
13	LAVARGE	38.2	3.7	0.0	21.4	0.0	47.4	0.072	0.
15	LAVARGE	29.3	2.4	0.0	16.8	0.0	41.5	0.063	0.
17	LAVARGE	23.1	1.3	0.0	13.7	0.0	37.5	0.067	0.
19	LAVARGE	17.2	0.2	0.0	7.8	0.0	32.1	0.056	0.
21	LAVARGE	10.6	-1.2	0.0	21.9	-1.4	56.1	0.082	0.
24	STINGER	-4.6	-5.1	0.0	21.6	-1.4	56.0	0.083	0.
26	STINGER	-11.0	-7.0	0.0	6.0	-0.3	31.4	0.053	0.
28	STINGER	-17.4	-9.0	0.0	11.7	-0.9	37.4	0.065	0.
30	STINGER	-23.7	-11.2	0.0	10.6	-0.8	35.9	0.062	0.
32	STINGER	-29.9	-13.5	0.0	6.8	3.9	33.2	0.053	0.
34	STINGER	-36.1	-15.9	0.0	22.9	-11.5	61.9	0.096	0.
47	SAGEBD	-174.3	-54.2	0.6	0.0	0.0	23.3	0.043	0.
50	SEAFED	-210.2	-56.0	0.1	2.6	-1.6	15.3	0.033	0.

===== SOLUTION SUMMARY =====

NOE	PIE	X	Y	Z	SUPPORT	REACT	TOTAL	TOTAL	ECT
-----	-----	---	---	---	---------	-------	-------	-------	-----

NO.	SECTION	COORD (M)	COORD (M)	COORD (M)	VERT (KN)	HORIZ (KN)	MOMENT (KN-M)	STRAIN (PCT)	ALL (%)
1	TENSION	77.8	6.2	0.0	-2.5	0.0	0.0	0.012	0.
3	LAYERGE	71.5	6.2	0.0	23.4	0.0	46.9	0.077	0.
5	LAYERGE	65.4	6.0	0.0	10.0	0.0	33.8	0.053	0.
7	LAYERGE	59.9	5.7	0.0	14.5	0.0	38.2	0.067	0.
9	LAYERGE	53.3	5.3	0.0	13.0	0.0	36.8	0.062	0.
11	LAYERGE	47.3	4.7	0.0	17.1	0.0	41.9	0.063	0.
13	LAYERGE	38.2	3.7	0.0	21.4	0.0	47.4	0.074	0.
15	LAYERGE	29.3	2.4	0.0	16.8	0.0	41.5	0.067	0.
17	LAYERGE	23.1	1.3	0.0	13.8	0.0	37.5	0.066	0.
19	LAYERGE	17.2	0.2	0.0	7.6	0.0	31.8	0.053	0.
21	LAYERGE	10.6	-1.2	0.0	22.5	-1.4	57.1	0.085	0.
24	STINGER	-4.6	-5.1	0.0	19.2	-1.4	47.2	0.072	0.
26	STINGER	-11.0	-6.9	0.0	4.3	-0.1	22.7	0.046	0.
28	STINGER	-17.4	-8.9	0.0	11.2	-2.0	30.1	0.052	0.
30	STINGER	-23.7	-10.9	0.0	7.0	2.3	23.3	0.043	0.
32	STINGER	-30.1	-13.1	0.0	0.0	0.0	24.4	0.044	0.
34	STINGER	-36.3	-15.4	0.0	38.5	-9.9	96.5	0.092	0.
47	SAGEBD	-174.3	-54.0	0.6	0.0	0.0	23.3	0.043	0.
51	SEAFBD	-222.3	-56.0	0.0	8.1	-3.4	8.0	0.025	0.

LAMPIRAN B
OUTPUT SOFTWARE MOSES
DAN DRAWING PIPELAYING BARGE
(PERMODELAN BARGE DAN RAO)

Input Permodelan Barge

```

$***** set data
$***** define body
&DESCRIBE BODY HULL
$***** DIMENSIONS
&DIMEN -SAVE -DIMEN METRES M-TONS
$***** define Hull
&DESCRIBE BODY Pipe_Lay_Barge
PGEN -PERM 1 -DIFTYPE STRIP -CS_CURR 0 0 0 -TANAKA 1
  PLANE 0 -RECT 3.02804 5.4864 27.432
  PLANE 0.87186 -RECT 2.71782 5.4864 27.432
  PLANE 1.74371 -RECT 2.4076 5.4864 27.432
  PLANE 2.61557 -RECT 2.09739 5.4864 27.432
  PLANE 3.48742 -RECT 1.78717 5.4864 27.432
  PLANE 4.35928 -RECT 1.47696 5.4864 27.432
  PLANE 5.23113 -RECT 1.16674 5.4864 27.432
  PLANE 6.10299 -RECT 0.85653 5.4864 27.432
  PLANE 6.97484 -RECT 0.54631 5.4864 27.432
  PLANE 7.8467 -RECT 0.2361 5.4864 27.432
  PLANE 8.71855 -RECT 0.01565 5.4864 27.432
  PLANE 15.4963 -RECT 0 5.4864 27.432
  PLANE 22.274 -RECT 0 5.4864 27.432
  PLANE 29.0517 -RECT 0 5.4864 27.432
  PLANE 35.8294 -RECT 0 5.4864 27.432
  PLANE 42.6071 -RECT 0 5.4864 27.432
  PLANE 49.3848 -RECT 0 5.4864 27.432
  PLANE 56.1625 -RECT 0 5.4864 27.432
  PLANE 62.9402 -RECT 0 5.4864 27.432
  PLANE 69.7179 -RECT 0 5.4864 27.432
  PLANE 76.4956 -RECT 0 5.4864 27.432
  PLANE 77.3721 -RECT 0.1593 5.4864 27.432
  PLANE 78.2486 -RECT 0.4716 5.4864 27.432
  PLANE 79.1251 -RECT 0.7839 5.4864 27.432
  PLANE 80.0016 -RECT 1.0962 5.4864 27.432
  PLANE 80.8781 -RECT 1.4085 5.4864 27.432
  PLANE 81.7546 -RECT 1.7208 5.4864 27.432
  PLANE 82.6311 -RECT 2.03311 5.4864 27.432
  PLANE 83.5076 -RECT 2.34541 5.4864 27.432
  PLANE 84.3841 -RECT 2.65771 5.4864 27.432
  PLANE 85.2606 -RECT 2.97003 5.4864 27.432
END PGEN
```

Output RAO MOSES

```

*****
*                                     *** MOSES ***                             *
*                                     -----                             *
*                                     December 19, 2019                       *
* Equilibrium Position                                                         *
* TUGAS AKHIR - PEMODELAN PIPELAY BARGE | Ida Bagus Punchara Sakyanary        *
* Draft      = 1.8 Meters      Trim Angle  = 0.02 Deg.                         *
* Roll Gy. Radius = 8.2 Meters  Pitch Gy. Radius = 24.2 Meters  Yaw Gy. Radius = 24.2 Meters *
* Heading    = 0.00 Deg.      Forward Speed = 0.00 Knots      Linearization Based on 1/ 20 *
*
*****

```

++ MOTION RESPONSE OPERATORS ++

Results are in Body System
 Of Point On Body PIPE_LAY At X = 42.7 Y = 0.0 Z = 2.2
 Process is DEFAULT: Units Are Degrees, Meters, and M-Tons Unless Specified

ENCOUNTER		Surge /	Sway /	Heave /	Roll /	Pitch /	Yaw /
Frequency	Period	Wave Ampl.	Wave Ampl.	Wave Ampl.	Wave Ampl.	Wave Ampl.	Wave Ampl.
-(Rad/Sec)-	-(Sec)-	Ampl. Phase	Ampl. Phase	Ampl. Phase	Ampl. Phase	Ampl. Phase	Ampl. Phase
0.1000	62.83	1.490 99	0.000 0	0.991 -3	0.000 0	0.061 -78	0.001 112
0.2000	31.42	1.018 90	0.000 0	0.987 -3	0.000 0	0.233 -89	0.000 0
0.3000	20.94	0.944 92	0.000 0	0.971 0	0.000 0	0.519 -87	0.000 0
0.4000	15.71	0.881 99	0.000 0	0.927 7	0.000 0	0.902 -81	0.000 0
0.5000	12.57	0.789 108	0.000 0	0.836 16	0.000 0	1.334 -73	0.000 0
0.6000	10.47	0.649 119	0.000 0	0.681 25	0.000 0	1.721 -64	0.000 0
0.7000	8.98	0.459 131	0.000 0	0.456 33	0.000 0	1.915 -56	0.000 0
0.8000	7.85	0.236 145	0.000 0	0.189 41	0.000 0	1.745 -48	0.000 0
0.9000	6.98	0.018 175	0.000 0	0.052 -119	0.000 0	1.142 -40	0.000 0
1.0000	6.28	0.140 -7	0.000 0	0.173 -115	0.000 0	0.302 -32	0.000 0
1.1000	5.71	0.189 11	0.000 0	0.139 -100	0.000 0	0.339 167	0.000 0
1.2000	5.24	0.121 30	0.000 0	0.027 -56	0.001 -51	0.493 -172	0.000 0
1.3000	4.83	0.007 -137	0.000 0	0.066 109	0.001 -61	0.238 -140	0.000 0
1.4000	4.49	0.094 -107	0.000 0	0.069 145	0.000 0	0.149 35	0.000 0
1.5000	4.19	0.076 -82	0.000 0	0.013 -107	0.001 148	0.284 77	0.000 0
1.6000	3.93	0.012 119	0.000 0	0.055 7	0.001 163	0.075 132	0.000 0
1.7000	3.70	0.062 149	0.000 0	0.026 53	0.000 0	0.209 -53	0.000 0
1.8000	3.49	0.023 179	0.000 0	0.041 -117	0.001 47	0.136 -12	0.000 0
1.9000	3.31	0.036 28	0.000 0	0.034 -75	0.000 0	0.161 -173	0.000 0
2.0000	3.14	0.025 62	0.000 0	0.037 127	0.001 -62	0.150 -133	0.000 0
2.1000	2.99	0.023 -85	0.000 0	0.034 169	0.000 0	0.154 73	0.000 0
2.2000	2.86	0.018 -48	0.000 0	0.039 18	0.001 -169	0.130 115	0.000 0
2.3000	2.73	0.018 167	0.000 0	0.023 59	0.000 0	0.157 -34	0.000 0

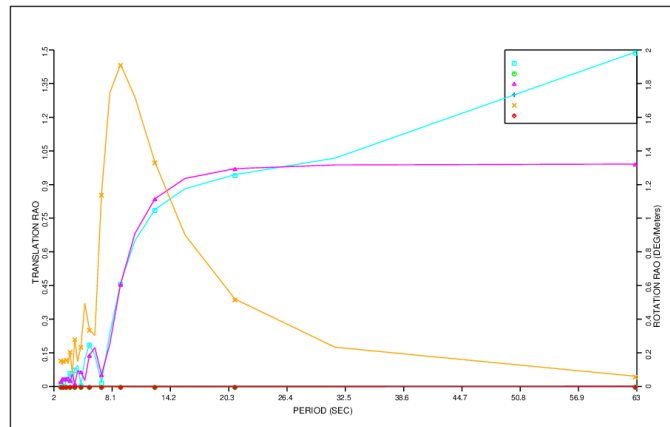

```

*****
*                                     *** MOSES ***                             *
*                                     -----                             *
*                                     December 19, 2019                       *
* Equilibrium Position                                                         *
* TUGAS AKHIR - PEMODELAN PIPELAY BARGE | Ida Bagus Purnhara Sakyanary        *
* Draft = 1.9 Meters Trim Angle = 0.01 Deg.                                   *
* Roll Gy. Radius = 8.2 Meters Pitch Gy. Radius = 24.2 Meters Yaw Gy. Radius = 24.2 Meters *
* Heading = 45.00 Deg. Forward Speed = 0.00 Knots Linearization Based on 1/ 20 *
*
*****

```

+++ MOTION RESPONSE OPERATORS +++

Results are in Body System
Of Point On Body PIPELAY At X = 42.7 Y = 0.0 Z = 2.2
Process is DEFAULT: Units Are Degrees, Meters, and M-Tons Unless Specified

ENCOUNTER		Surge /		Sway /		Heave /		Roll /		Pitch /		Yaw /	
Frequency	Period	Wave Ampl.		Wave Ampl.		Wave Ampl.		Wave Ampl.		Wave Ampl.		Wave Ampl.	
-(Rad/Sec)-	-(Sec)-	Ampl.	Phase	Ampl.	Phase	Ampl.	Phase	Ampl.	Phase	Ampl.	Phase	Ampl.	Phase
0.1000	62.83	1.063	90	1.762	142	0.988	-3	0.041	88	0.040	-76	1.526	-89
0.2000	31.42	0.721	85	0.783	105	0.988	-5	0.161	84	0.165	-90	0.137	-156
0.3000	20.94	0.674	86	0.700	95	0.980	-4	0.358	85	0.369	-92	0.238	-172
0.4000	15.71	0.643	89	0.661	94	0.956	-1	0.620	88	0.648	-90	0.382	-174
0.5000	12.57	0.604	93	0.614	96	0.907	2	0.919	92	0.985	-87	0.541	-172
0.6000	10.47	0.546	97	0.546	98	0.821	5	1.199	95	1.343	-84	0.688	-168
0.7000	8.98	0.464	101	0.453	101	0.687	7	1.379	99	1.654	-82	0.796	-162
0.8000	7.85	0.358	104	0.336	104	0.504	8	1.359	101	1.819	-82	0.841	-156
0.9000	6.98	0.232	109	0.206	108	0.285	8	1.045	104	1.722	-83	0.807	-148
1.0000	6.28	0.100	114	0.082	117	0.071	8	0.385	104	1.317	-83	0.683	-139
1.1000	5.71	0.019	-71	0.021	-131	0.075	-172	0.564	-74	0.725	-81	0.476	-129
1.2000	5.24	0.101	-59	0.038	-92	0.123	-167	1.354	-87	0.176	-75	0.222	-120
1.3000	4.83	0.128	-53	0.025	-22	0.096	-158	1.189	-104	0.177	109	0.013	122
1.4000	4.49	0.098	-47	0.036	1	0.037	-146	0.332	-107	0.287	120	0.144	88
1.5000	4.19	0.030	-40	0.017	-11	0.015	33	0.224	72	0.199	130	0.152	99
1.6000	3.93	0.037	144	0.011	-104	0.032	49	0.352	93	0.032	139	0.073	114
1.7000	3.70	0.066	151	0.014	-114	0.018	61	0.199	117	0.075	-24	0.011	-26
1.8000	3.49	0.043	159	0.007	-113	0.003	-86	0.058	-71	0.068	-11	0.044	-12
1.9000	3.31	0.006	-17	0.006	154	0.009	-79	0.181	-37	0.008	-17	0.030	21
2.0000	3.14	0.039	-5	0.008	157	0.003	-53	0.089	-20	0.022	-136	0.004	-130
2.1000	2.99	0.028	4	0.002	153	0.003	176	0.058	178	0.014	-85	0.028	-95
2.2000	2.86	0.007	-169	0.006	27	0.004	-130	0.070	-163	0.004	116	0.014	-71
2.3000	2.73	0.026	-157	0.004	47	0.001	-85	0.003	154	0.017	166	0.015	137

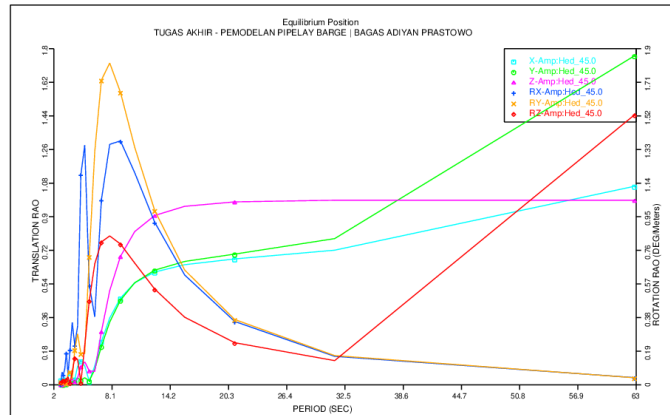

```

*****
*                                     *** MOSES ***                             *
*                                     -----                             *
*                                     December 19, 2019                       *
* Equilibrium Position                                                         *
* TUGAS AKHIR - PEMODELAN PIPELAY BARGE | Ida Bagus Purnhara Sakyanary        *
* Draft = 1.9 Meters Trim Angle = -0.00 Deg.                                  *
* Roll Gy. Radius = 8.2 Meters Pitch Gy. Radius = 24.2 Meters Yaw Gy. Radius = 24.2 Meters *
* Heading = 90.00 Deg. Forward Speed = 0.00 Knots Linearization Based on 1/ 20 *
*
*****

```

+++ MOTION RESPONSE OPERATORS +++

Results are in Body System
Of Point On Body PIPELAY At X = 42.7 Y = 0.0 Z = 2.2
Process is DEFAULT: Units Are Degrees, Meters, and M-Tons Unless Specified

ENCOUNTER		Surge /	Sway /	Heave /	Roll /	Pitch /	Yaw /
Frequency	Period	Wave Ampl.		Wave Ampl.		Wave Ampl.	
-(Rad/Sec)-	-(Sec)-	Ampl.	Phase	Ampl.	Phase	Ampl.	Phase
0.1000	62.83	0.038	-5	2.069	132	0.988	-6
0.2000	31.42	0.008	-17	1.079	91	0.990	-14
0.3000	20.94	0.003	-29	0.993	74	0.988	-22
0.4000	15.71	0.002	-42	0.957	60	0.985	-32
0.5000	12.57	0.001	-61	0.922	45	0.980	-46
0.6000	10.47	0.001	-84	0.877	27	0.974	-63
0.7000	8.98	0.001	-116	0.815	4	0.966	-86
0.8000	7.85	0.000	0	0.734	-21	0.951	-113
0.9000	6.98	0.000	0	0.632	-50	0.909	-146
1.0000	6.28	0.000	0	0.505	-84	0.815	175
1.1000	5.71	0.000	0	0.347	-120	0.664	135
1.2000	5.24	0.000	0	0.161	-150	0.497	95
1.3000	4.83	0.000	0	0.101	-106	0.357	57
1.4000	4.49	0.000	0	0.200	-128	0.253	21
1.5000	4.19	0.000	0	0.229	-170	0.181	-14
1.6000	3.93	0.000	0	0.218	147	0.131	-50
1.7000	3.70	0.000	0	0.196	108	0.096	-86
1.8000	3.49	0.000	0	0.173	68	0.071	-123
1.9000	3.31	0.000	0	0.152	28	0.053	-162
2.0000	3.14	0.000	0	0.133	-13	0.040	157
2.1000	2.99	0.000	0	0.117	-55	0.030	116
2.2000	2.86	0.000	0	0.103	-99	0.023	72
2.3000	2.73	0.000	0	0.091	-145	0.017	27

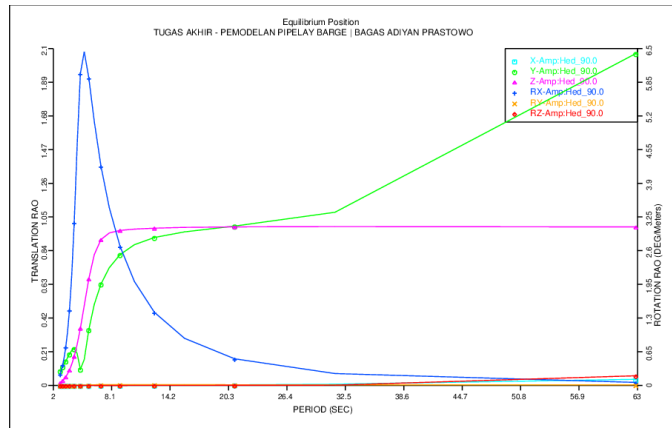

```

*****
*                                     *** MOSES ***                             *
*                                     December 19, 2019                          *
* Equilibrium Position                                                            *
* TUGAS AKHIR - PEMODELAN PIPELAY BARGE | Ida Bagus Purnhara Sakyanary          *
* Draft = 1.9 Meters                    Trim Angle = -0.01 Deg.                  *
* Roll Gy. Radius = 8.2 Meters           Pitch Gy. Radius = 24.2 Meters         *
* Heading = 135.00 Deg.                  Forward Speed = 0.00 Knots             *
* Linearization Based on 1/ 20                                                  *
*****

```

++ MOTION RESPONSE OPERATORS ++

Results are in Body System
 Of Point On Body PIPELAY At X = 42.7 Y = 0.0 Z = 2.2
 Process is DEFAULT: Units Are Degrees, Meters, and M-Tons Unless Specified

ENCOUNTER		Surge /		Sway /		Heave /		Roll /		Pitch /		Yaw /	
		Wave Ampl.		Wave Ampl.		Wave Ampl.		Wave Ampl.		Wave Ampl.		Wave Ampl.	
Frequency	Period	Ampl.	Phase	Ampl.	Phase	Ampl.	Phase	Ampl.	Phase	Ampl.	Phase	Ampl.	Phase
0.1000	62.83	1.072	-88	1.765	139	0.988	-7	0.041	84	0.038	70	1.471	73
0.2000	31.42	0.722	-107	0.783	91	0.988	-19	0.161	70	0.163	67	0.143	7
0.3000	20.94	0.675	-125	0.700	63	0.980	-35	0.358	54	0.364	52	0.241	-24
0.4000	15.71	0.644	-147	0.661	37	0.957	-57	0.620	32	0.640	31	0.383	-51
0.5000	12.57	0.604	-175	0.614	7	0.909	-85	0.919	4	0.973	3	0.542	-80
0.6000	10.47	0.546	149	0.546	-28	0.824	-121	1.199	-30	1.327	-32	0.689	-115
0.7000	8.98	0.465	106	0.453	-71	0.694	-164	1.379	-73	1.637	-75	0.796	-155
0.8000	7.85	0.358	56	0.337	-120	0.513	142	1.359	-123	1.803	-128	0.841	157
0.9000	6.98	0.232	0	0.206	-176	0.293	82	1.044	179	1.712	171	0.807	106
1.0000	6.28	0.100	-63	0.082	125	0.077	11	0.384	112	1.313	104	0.683	48
1.1000	5.71	0.019	40	0.021	162	0.073	125	0.563	-140	0.725	32	0.475	-16
1.2000	5.24	0.101	-32	0.039	121	0.123	46	1.340	125	0.176	-41	0.222	-88
1.3000	4.83	0.128	-115	0.026	96	0.096	-33	1.181	21	0.177	54	0.014	67
1.4000	4.49	0.098	153	0.036	27	0.037	-117	0.329	-74	0.287	-29	0.144	-63
1.5000	4.19	0.030	55	0.017	-85	0.015	-35	0.223	0	0.199	-120	0.152	-154
1.6000	3.93	0.037	133	0.010	72	0.032	-130	0.351	-86	0.032	142	0.073	110
1.7000	3.70	0.066	21	0.014	-55	0.018	124	0.202	-177	0.075	-142	0.012	-142
1.8000	3.49	0.043	-95	0.007	-178	0.004	-148	0.058	-137	0.067	108	0.044	104
1.9000	3.31	0.006	-35	0.006	-36	0.009	89	0.180	131	0.007	-18	0.030	7
2.0000	3.14	0.039	-169	0.008	-173	0.003	-17	0.089	14	0.022	73	0.004	93
2.1000	2.99	0.028	52	0.002	29	0.003	61	0.058	63	0.014	-14	0.028	-30
2.2000	2.86	0.007	91	0.006	122	0.004	-32	0.070	-66	0.004	22	0.014	-161
2.3000	2.73	0.026	-61	0.004	-20	0.001	-137	0.001	79	0.017	-74	0.015	-103

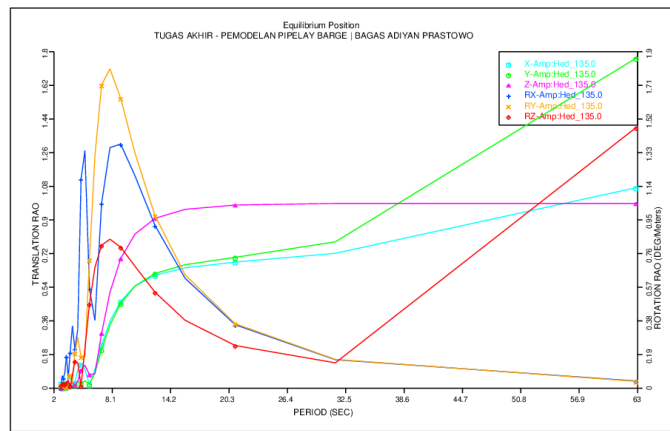

```

*****
*                                     *** MOSES ***                             *
*                                     -----                             *
*                                     December 19, 2019                       *
* Equilibrium Position                                                         *
* TUGAS AKHIR - PEMODELAN PIPELAY BARGE | Ida Bagus Pundhara Sakyanary        *
* Draft = 1.9 Meters Trim Angle = -0.03 Deg.                                  *
* Roll Gy. Radius = 8.2 Meters Pitch Gy. Radius = 24.2 Meters Yaw Gy. Radius = 24.2 Meters *
* Heading = 180.00 Deg. Forward Speed = 0.00 Knots Linearization Based on 1/ 20 *
*
*****

```

++ MOTION RESPONSE OPERATORS ++

Results are in Body System
Of Point On Body PIPE_LAY At X = 42.7 Y = 0.0 Z = 2.2
Process is DEFAULT: Units Are Degrees, Meters, and M-Tons Unless Specified

ENCOUNTER		Surge /		Sway /		Heave /		Roll /		Pitch /		Yaw /	
Frequency	Period	Wave Ampl.		Wave Ampl.		Wave Ampl.		Wave Ampl.		Wave Ampl.		Wave Ampl.	
-(Rad/Sec)-	-(Sec)-	Ampl.	Phase	Ampl.	Phase	Ampl.	Phase	Ampl.	Phase	Ampl.	Phase	Ampl.	Phase
0.1000	62.83	1.513	-82	0.000	0	0.991	-8	0.000	0	0.058	76	0.000	0
0.2000	31.42	1.019	-109	0.000	0	0.987	-23	0.000	0	0.231	65	0.000	0
0.3000	20.94	0.945	-132	0.000	0	0.971	-44	0.000	0	0.515	45	0.000	0
0.4000	15.71	0.882	-161	0.000	0	0.928	-72	0.000	0	0.894	17	0.000	0
0.5000	12.57	0.789	163	0.000	0	0.839	-108	0.000	0	1.323	-18	0.000	0
0.6000	10.47	0.650	118	0.000	0	0.685	-153	0.000	0	1.709	-64	0.000	0
0.7000	8.98	0.459	64	0.000	0	0.463	149	0.000	0	1.902	-120	0.000	0
0.8000	7.85	0.235	2	0.000	0	0.197	81	0.000	0	1.736	173	0.000	0
0.9000	6.98	0.017	-59	0.000	0	0.048	-156	0.000	0	1.139	97	0.000	0
1.0000	6.28	0.140	29	0.000	0	0.172	108	0.000	0	0.304	11	0.000	0
1.1000	5.71	0.188	-58	0.000	0	0.140	17	0.000	0	0.337	105	0.000	0
1.2000	5.24	0.120	-155	0.000	0	0.028	-56	0.001	-54	0.495	11	0.000	0
1.3000	4.83	0.007	-74	0.000	0	0.065	-10	0.001	178	0.244	-80	0.000	0
1.4000	4.49	0.094	165	0.000	0	0.070	-108	0.000	0	0.148	-41	0.000	0
1.5000	4.19	0.076	43	0.000	0	0.013	-151	0.001	102	0.287	-140	0.000	0
1.6000	3.93	0.012	97	0.000	0	0.055	174	0.001	-28	0.082	120	0.000	0
1.7000	3.70	0.062	-45	0.000	0	0.027	55	0.000	0	0.209	128	0.000	0
1.8000	3.49	0.023	164	0.000	0	0.041	70	0.001	-126	0.141	-2	0.000	0
1.9000	3.31	0.036	-168	0.000	0	0.034	-70	0.000	0	0.161	8	0.000	0
2.0000	3.14	0.025	25	0.000	0	0.037	-62	0.001	101	0.153	-142	0.000	0
2.1000	2.99	0.023	35	0.000	0	0.034	135	0.000	0	0.153	-141	0.000	0
2.2000	2.86	0.018	-147	0.000	0	0.039	130	0.001	-63	0.133	49	0.000	0
2.3000	2.73	0.018	-155	0.000	0	0.023	-47	0.000	0	0.155	34	0.000	0

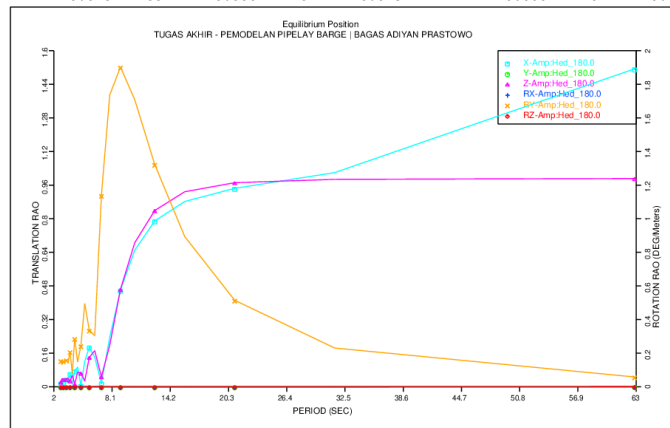

LAMPIRAN C
OUTPUT SOFTWARE OFFPIPE
(ANALISIS DINAMIS)

OUTPUT ANALISA DINAMIS HEADING 0°

OFFPIPE - OFFSHORE PIPELINE ANALYSIS SYSTEM - VERSION 2.05 AC DATE - 5/ 6/2020 TIME - 21: 6:22 PAGE 106
 PROJECT - TUGAS AKHIR JOB NO. - ANALISIS DINAMIS
 USER ID - IIDA BAGUS FUNDHARA SAKYANARY LICENSED TO: RICKY TAWEKAL CASE 1

NODE PERCENT NO. YIELD (PCT)	PIPE SECTION	X	Y	Z	HORIZ	VERT	PIPE	TENSILE	HOOP	BENDING STRESSES		TOTAL
		COORD (M)	COORD (M)	COORD (M)	ANGLE (DEG)	ANGLE (DEG)	LENGIH (M)	STRESS (MEA)	STRESS (MEA)	VERT (MEA)	HORIZ (MEA)	STRESS (MEA)
1	TENSIONR	77.79	6.21	0.00	0.000	0.315	0.00	48.72	0.00	0.00	0.00	48.72
13.53												
3	LAYBARGE	71.49	6.16	0.00	0.000	0.956	6.30	48.70	0.00	-106.58	0.00	139.29
38.69												
5	LAYBARGE	65.37	5.99	0.00	0.000	2.222	12.42	48.68	0.00	-76.69	0.00	113.86
31.63												
7	LAYBARGE	59.91	5.72	0.00	0.000	3.296	17.89	48.63	0.00	-87.55	0.00	123.05
34.18												
9	LAYBARGE	53.32	5.28	0.00	0.000	4.485	24.49	48.56	0.00	-84.15	0.00	120.08
33.36												
11	LAYBARGE	47.32	4.74	0.00	0.000	5.780	30.51	48.47	0.00	-103.45	0.00	136.40
37.89												
13	LAYBARGE	38.21	3.69	0.00	0.000	7.420	39.68	48.30	0.00	-124.47	0.00	154.10
42.80												
15	LAYBARGE	29.27	2.39	0.00	0.000	9.064	48.72	48.10	0.00	-102.42	0.02	135.15
37.54												
17	LAYBARGE	23.13	1.34	0.00	0.000	10.380	54.95	47.94	0.00	-85.48	-0.08	120.59
33.50												
19	LAYBARGE	17.18	0.19	0.00	0.002	11.411	61.01	47.76	0.00	-68.32	0.35	105.82
29.39												
21	LAYBARGE	10.63	-1.22	0.00	-0.022	13.187	67.72	47.55	-0.08	-159.12	-5.28	182.91
50.81												
24	STINGER	-4.64	-5.13	0.00	0.026	15.809	83.47	47.04	-0.34	-201.94	-4.67	218.87
60.80												
26	STINGER	-11.01	-7.10	0.00	-0.021	18.258	90.14	46.81	-0.47	-101.60	-3.14	133.45
37.07												
28	STINGER	-17.30	-9.29	0.00	0.071	20.060	96.81	46.53	-0.62	-125.95	10.97	154.24
42.85												
30	STINGER	-23.53	-11.68	0.00	-0.319	21.938	103.47	46.22	-0.78	-110.08	-57.43	151.41
42.06												
32	STINGER	-29.68	-14.24	0.08	-0.969	22.819	110.14	45.91	-0.95	-12.52	-17.75	64.58
17.94												
34	STINGER	-35.83	-16.81	0.19	-1.093	22.536	116.81	45.58	-1.12	25.71	1.06	67.60
18.78												
36	SAGEBEND	-46.96	-21.30	0.39	-0.951	21.327	128.81	45.00	-1.42	32.90	4.11	73.61
20.45												
37	SAGEBEND	-58.19	-25.53	0.56	-0.777	20.021	140.81	44.45	-1.70	33.81	4.17	74.08
20.58												
38	SAGEBEND	-69.51	-29.51	0.70	-0.606	18.687	152.81	43.94	-1.97	34.37	4.02	74.21
20.61												
39	SAGEBEND	-80.92	-33.22	0.80	-0.445	17.328	164.81	43.46	-2.22	34.87	3.84	74.31
20.64												
40	SAGEBEND	-92.42	-36.65	0.88	-0.291	15.950	176.81	43.02	-2.44	35.39	3.69	74.45
20.68												
41	SAGEBEND	-103.99	-39.81	0.92	-0.144	14.553	188.81	42.61	-2.65	35.92	3.51	74.55
20.71												

42	SAGEBEND	-115.64	-42.68	0.93	-0.007	13.138	200.81	42.24	-2.85	36.38	3.31	74.68
20.75												
43	SAGEBEND	-127.36	-45.27	0.92	0.121	11.706	212.81	41.91	-3.02	36.78	3.07	74.76
20.77												
44	SAGEBEND	-139.14	-47.55	0.89	0.237	10.261	224.81	41.62	-3.17	37.12	2.83	74.81
20.78												
45	SAGEBEND	-150.98	-49.54	0.83	0.345	8.800	236.81	41.36	-3.30	37.39	2.57	74.84
20.79												
46	SAGEBEND	-162.86	-51.22	0.74	0.441	7.328	248.81	41.15	-3.41	37.62	2.33	74.84
20.79												
47	SAGEBEND	-174.78	-52.60	0.64	0.528	5.848	260.81	40.97	-3.51	37.86	2.17	74.83
20.79												
48	SAGEBEND	-186.73	-53.67	0.52	0.610	4.359	272.81	40.84	-3.58	38.07	2.11	74.80
20.78												
49	SAGEBEND	-198.70	-54.42	0.39	0.691	2.863	284.81	40.74	-3.63	38.14	2.08	74.68
20.74												
50	SAGEBEND	-210.69	-54.87	0.24	0.762	1.383	296.81	40.68	-3.65	36.80	1.25	73.44
20.40												
51	SEABED	-222.69	-55.02	0.08	0.662	0.177	308.81	40.66	-3.66	17.03	-11.51	59.17
16.44												
52	SEABED	-234.69	-55.03	0.00	0.083	-0.002	320.81	40.66	-3.66	0.44	-8.45	49.55
13.76												
53	SEABED	-246.69	-55.02	0.00	-0.001	0.000	332.81	40.66	-3.66	-0.04	-0.16	42.75
11.87												
54	SEABED	-258.69	-55.02	0.00	0.000	0.000	344.81	40.66	-3.66	0.00	0.02	42.63
11.84												
55	SEABED	-270.69	-55.02	0.00	0.000	0.000	356.81	40.66	-3.66	0.00	0.00	42.62
11.84												
56	SEABED	-282.69	-55.02	0.00	0.000	0.000	368.81	40.66	-3.66	0.00	0.00	42.61
11.84												
57	SEABED	-294.69	-55.02	0.00	0.000	0.000	380.81	40.66	-3.66	0.00	0.00	42.61
11.84												
58	SEABED	-306.69	-55.02	0.00	0.000	0.000	392.81	40.66	-3.66	0.00	0.00	42.62
11.84												

OFFPIPE - OFFSHORE PIPELINE ANALYSIS SYSTEM - VERSION 2.05 AC DATE - 5/ 6/2020 TIME - 21: 6:22 PAGE 106
PROJECT - TUGAS AKHIR JOB NO. - ANALISIS DINAMIS
USER ID - IDA BAGUS FUNDHARA SAKYANARY LICENSED TO: RICKY TAMEKAL CASE 2

NODE FRONT NO. YIELD (PCT)	PIPE SECTION	X	Y	Z	HORIZ	VERT	PIPE	TENSILE	HOOP	BENDING STRESSES		TOTAL
		COORD (M)	COORD (M)	COORD (M)	ANGLE (DEG)	ANGLE (DEG)	LENGIH (M)	STRESS (MPA)	STRESS (MPA)	VERT (MPA)	HORIZ (MPA)	STRESS (MPA)

1	TENSTONR	77.79	6.21	0.00	0.000	0.314	0.00	48.72	0.00	0.00	0.00	48.72
13.53												
3	LAVBARGE	71.49	6.16	0.00	0.000	0.955	6.30	48.70	0.00	-106.59	0.00	139.29
38.69												
5	LAVBARGE	65.38	5.98	0.00	0.000	2.220	12.42	48.68	0.00	-76.69	0.00	113.87
31.63												
7	LAVBARGE	59.91	5.72	0.00	0.000	3.295	17.89	48.64	0.00	-87.56	0.00	123.05
34.18												
9	LAVBARGE	53.32	5.27	0.00	0.000	4.484	24.49	48.57	0.00	-84.15	0.00	120.09
33.36												
11	LAVBARGE	47.32	4.74	0.00	0.000	5.779	30.51	48.48	0.00	-103.45	0.00	136.40
37.89												
13	LAVBARGE	38.22	3.69	0.00	0.000	7.419	39.68	48.31	0.00	-124.48	0.00	154.10
42.80												
15	LAVBARGE	29.27	2.39	0.00	0.000	9.063	48.72	48.11	0.00	-102.42	0.02	135.16
37.54												
17	LAVBARGE	23.13	1.33	0.00	0.000	10.378	54.95	47.94	0.00	-85.49	-0.08	120.59
33.50												
19	LAVBARGE	17.18	0.19	0.00	0.002	11.410	61.01	47.77	0.00	-68.31	0.33	105.78
29.38												
21	LAVBARGE	10.63	-1.22	0.00	-0.021	13.186	67.72	47.56	-0.08	-159.14	-5.24	182.92
50.81												
24	STINGER	-4.64	-5.13	0.00	0.023	15.807	83.47	47.04	-0.34	-201.78	-5.07	218.75
60.76												
26	STINGER	-11.00	-7.10	0.00	-0.009	18.261	90.14	46.82	-0.47	-102.45	-1.47	134.12
37.26												
28	STINGER	-17.30	-9.29	0.00	0.021	20.037	96.81	46.53	-0.62	-122.16	3.32	150.69
41.86												
30	STINGER	-23.53	-11.67	0.01	-0.489	21.820	103.47	46.23	-0.78	-105.51	-61.30	150.10
41.70												
32	STINGER	-29.70	-14.21	0.11	-1.084	22.472	110.14	45.91	-0.95	10.17	-6.55	56.19
15.61												
34	STINGER	-35.86	-16.73	0.23	-1.097	21.991	116.81	45.59	-1.12	28.93	2.61	70.59
19.61												
36	SAGEBND	-47.04	-21.11	0.43	-0.935	20.738	128.81	45.02	-1.41	33.14	4.24	73.88
20.52												
37	SAGEBND	-58.31	-25.23	0.59	-0.760	19.423	140.81	44.49	-1.68	33.88	4.21	74.18
20.61												
38	SAGEBND	-69.67	-29.08	0.73	-0.590	18.082	152.81	44.00	-1.94	34.41	4.08	74.31
20.64												
39	SAGEBND	-81.12	-32.68	0.83	-0.427	16.721	164.81	43.53	-2.18	34.91	3.92	74.43
20.67												
40	SAGEBND	-92.65	-35.99	0.90	-0.272	15.341	176.81	43.11	-2.40	35.42	3.79	74.54
20.71												
41	SAGEBND	-104.26	-39.03	0.94	-0.124	13.944	188.81	42.71	-2.60	35.92	3.65	74.68
20.74												
42	SAGEBND	-115.94	-41.78	0.95	0.015	12.530	200.81	42.36	-2.79	36.38	3.50	74.79
20.77												
43	SAGEBND	-127.69	-44.23	0.93	0.146	11.099	212.81	42.04	-2.95	36.76	3.30	74.86
20.80												
44	SAGEBND	-139.49	-46.39	0.89	0.268	9.654	224.81	41.77	-3.09	37.07	3.11	74.91
20.81												
45	SAGEBND	-151.34	-48.25	0.82	0.380	8.194	236.81	41.53	-3.22	37.30	2.94	74.94
20.82												
46	SAGEBND	-163.24	-49.81	0.73	0.484	6.722	248.81	41.33	-3.32	37.56	2.78	74.94
20.82												
47	SAGEBND	-175.18	-51.06	0.62	0.579	5.243	260.81	41.17	-3.40	37.79	2.68	74.91
20.81												
48	SAGEBND	-187.14	-52.00	0.49	0.667	3.758	272.81	41.05	-3.47	37.95	2.60	74.84
20.79												
49	SAGEBND	-199.12	-52.64	0.34	0.749	2.271	284.81	40.97	-3.51	37.86	2.40	74.58
20.72												
50	SAGEBND	-211.11	-52.96	0.18	0.799	0.825	296.81	40.93	-3.53	34.11	-1.72	71.39
19.83												
51	SEABED	-223.11	-53.02	0.04	0.451	0.032	308.81	40.92	-3.53	5.42	-16.58	57.07
15.85												

52	SEABED	-235.11	-53.03	0.00	0.018	-0.002	320.81	40.92	-3.53	-0.07	-3.37	45.42
12.62												
53	SEABED	-247.11	-53.02	0.00	-0.001	0.000	332.81	40.92	-3.53	-0.01	0.05	42.83
11.90												
54	SEABED	-259.11	-53.02	0.00	0.000	0.000	344.81	40.92	-3.53	0.00	0.01	42.80
11.89												
55	SEABED	-271.11	-53.02	0.00	0.000	0.000	356.81	40.92	-3.53	0.00	0.00	42.79
11.89												
56	SEABED	-283.11	-53.02	0.00	0.000	0.000	368.81	40.92	-3.53	0.00	0.00	42.79
11.89												
57	SEABED	-295.11	-53.02	0.00	0.000	0.000	380.81	40.92	-3.53	0.00	0.00	42.79
11.89												
58	SEABED	-307.11	-53.02	0.00	0.000	0.000	392.81	40.92	-3.53	0.00	0.00	42.79
11.89												

OFFPIPE - OFFSHORE PIPELINE ANALYSIS SYSTEM - VERSION 2.05 AC DATE - 5/ 6/2020 TIME - 21: 6:22 PAGE 106
 PROJECT - TUGAS AKHIR JOB NO. - ANALISIS DINAMIS
 USER ID - IDA BAGUS FUNDHARA SAKYANARY LICENSED TO: RICKY TAWEKAL CASE 3

NODE EBCENT NO.	PIPE SECTION	X COORD (M)	Y COORD (M)	Z COORD (M)	HORIZ ANGLE (DEG)	VERT ANGLE (DEG)	PIPE LENGIH (M)	TENSILE STRESS (MPA)	HOOP STRESS (MPA)	BENDING STRESSES VERT (MPA)	HORIZ (MPA)	TOTAL STRESS (MPA)
1	TENSIONR	77.79	6.21	0.00	0.000	0.313	0.00	48.69	0.00	0.00	0.00	48.69
13.53												
3	LAYBARGE	71.49	6.16	0.00	0.000	0.955	6.30	48.67	0.00	-106.57	0.00	139.25
38.68												
5	LAYBARGE	65.37	5.98	0.00	0.000	2.220	12.42	48.65	0.00	-76.68	0.00	113.83
31.62												
7	LAYBARGE	59.91	5.72	0.00	0.000	3.295	17.89	48.61	0.00	-87.54	0.00	123.01
34.17												
9	LAYBARGE	53.32	5.27	0.00	0.000	4.483	24.49	48.54	0.00	-84.13	0.00	120.05
33.35												
11	LAYBARGE	47.32	4.74	0.00	0.000	5.779	30.51	48.45	0.00	-103.43	0.00	136.36
37.88												
13	LAYBARGE	38.21	3.69	0.00	0.000	7.419	39.68	48.28	0.00	-124.44	0.00	154.05
42.79												
15	LAYBARGE	29.27	2.39	0.00	0.000	9.063	48.72	48.08	0.00	-102.40	0.01	135.12
37.53												

17	LAVARGE	23.13	1.33	0.00	0.000	10.378	54.95	47.91	0.00	-85.49	-0.07	120.57
33.49												
19	LAVARGE	17.18	0.19	0.00	0.002	11.410	61.01	47.74	0.00	-68.26	0.33	105.73
29.37												
21	LAVARGE	10.63	-1.22	0.00	-0.021	13.186	67.72	47.53	-0.08	-159.32	-5.20	183.05
50.85												
24	STINGER	-4.62	-5.11	0.00	0.022	15.376	83.45	47.03	-0.34	-158.78	-5.17	182.22
50.62												
26	STINGER	-11.02	-6.99	0.00	-0.004	17.151	90.12	46.81	-0.47	-66.45	-0.25	103.52
28.76												
28	STINGER	-17.37	-9.02	0.00	-0.004	18.309	96.78	46.54	-0.60	-86.33	-2.35	120.25
33.40												
30	STINGER	-23.67	-11.19	0.00	0.021	19.622	103.45	46.26	-0.75	-84.17	2.84	118.21
32.84												
32	STINGER	-29.93	-13.49	0.00	-0.096	20.827	110.12	45.97	-0.90	-73.64	-19.48	110.71
30.75												
34	STINGER	-36.14	-15.92	0.03	-0.627	21.816	116.79	45.66	-1.06	-61.61	-43.63	110.19
30.61												
36	SAGEBND	-47.27	-20.40	0.22	-1.000	21.541	128.79	45.08	-1.36	28.18	1.80	69.42
19.28												
37	SAGEBND	-58.47	-24.69	0.40	-0.852	20.288	140.79	44.53	-1.65	33.45	4.06	73.77
20.49												
38	SAGEBND	-69.78	-28.72	0.55	-0.682	18.960	152.79	44.01	-1.91	34.26	4.05	74.12
20.59												
39	SAGEBND	-81.17	-32.48	0.67	-0.519	17.609	164.79	43.52	-2.17	34.78	3.87	74.24
20.62												
40	SAGEBND	-92.65	-35.97	0.76	-0.363	16.237	176.79	43.07	-2.40	35.28	3.72	74.38
20.66												
41	SAGEBND	-104.21	-39.19	0.82	-0.215	14.844	188.79	42.66	-2.61	35.77	3.54	74.52
20.70												
42	SAGEBND	-115.85	-42.12	0.85	-0.076	13.430	200.79	42.28	-2.81	36.25	3.35	74.66
20.74												
43	SAGEBND	-127.55	-44.76	0.85	0.054	12.000	212.79	41.94	-2.98	36.71	3.12	74.75
20.76												
44	SAGEBND	-139.32	-47.11	0.83	0.173	10.560	224.79	41.64	-3.14	37.10	2.87	74.81
20.78												
45	SAGEBND	-151.14	-49.16	0.78	0.283	9.100	236.79	41.38	-3.28	37.40	2.62	74.83
20.79												
46	SAGEBND	-163.01	-50.90	0.71	0.381	7.630	248.79	41.15	-3.39	37.61	2.36	74.84
20.79												
47	SAGEBND	-174.93	-52.34	0.62	0.470	6.154	260.79	40.97	-3.49	37.82	2.17	74.84
20.79												
48	SAGEBND	-186.87	-53.47	0.51	0.552	4.666	272.79	40.82	-3.56	38.05	2.09	74.83
20.79												
49	SAGEBND	-198.84	-54.29	0.39	0.633	3.171	284.79	40.72	-3.62	38.18	2.07	74.75
20.76												
50	SAGEBND	-210.83	-54.80	0.25	0.709	1.684	296.79	40.65	-3.65	37.49	1.62	74.01
20.56												
51	SEABED	-222.83	-55.01	0.10	0.693	0.343	308.79	40.63	-3.66	25.57	-6.72	64.46
17.91												
52	SEABED	-234.83	-55.03	0.01	0.142	0.002	320.79	40.63	-3.66	1.26	-11.67	52.36
14.54												
53	SEABED	-246.83	-55.02	0.00	0.000	-0.001	332.79	40.63	-3.66	-0.06	-0.39	42.89
11.91												
54	SEABED	-258.83	-55.02	0.00	0.000	0.000	344.79	40.63	-3.66	0.00	0.03	42.60
11.83												
55	SEABED	-270.83	-55.02	0.00	0.000	0.000	356.79	40.63	-3.66	0.00	0.00	42.58
11.83												
56	SEABED	-282.83	-55.02	0.00	0.000	0.000	368.79	40.63	-3.66	0.00	0.00	42.58
11.83												
57	SEABED	-294.83	-55.02	0.00	0.000	0.000	380.79	40.63	-3.66	0.00	0.00	42.58
11.83												
58	SEABED	-306.83	-55.02	0.00	0.000	0.000	392.79	40.63	-3.66	0.00	0.00	42.58
11.83												

NODE FRONT YIELD	PIPE SECTION	X COORD (M)	Y COORD (M)	Z COORD (M)	HORIZ ANGLE (DEG)	VERT ANGLE (DEG)	PIPE LENGIH (M)	TENSILE STRESS (MPA)	HOOP STRESS (MPA)	BENDING STRESSES VERT (MPA)	HORIZ (MPA)	TOTAL STRESS (MPA)
1	TENSIONR	77.79	6.21	0.00	0.000	0.316	0.00	48.72	0.00	0.00	0.00	48.72
13.53												
3	LAVARGE	71.49	6.16	0.00	0.000	0.957	6.30	48.70	0.00	-106.60	0.00	139.31
38.70												
5	LAVARGE	65.38	5.98	0.00	0.000	2.223	12.42	48.67	0.00	-76.70	0.00	113.87
31.63												
7	LAVARGE	59.91	5.72	0.00	0.000	3.297	17.89	48.63	0.00	-87.56	0.00	123.06
34.18												
9	LAVARGE	53.32	5.27	0.00	0.000	4.486	24.49	48.56	0.00	-84.15	0.00	120.09
33.36												
11	LAVARGE	47.32	4.74	0.00	0.000	5.781	30.51	48.47	0.00	-103.46	0.00	136.41
37.89												
13	LAVARGE	38.22	3.69	0.00	0.000	7.421	39.68	48.30	0.00	-124.48	0.00	154.11
42.81												
15	LAVARGE	29.27	2.39	0.00	0.000	9.065	48.72	48.10	0.00	-102.42	0.01	135.16
37.54												
17	LAVARGE	23.13	1.33	0.00	0.000	10.381	54.95	47.94	0.00	-85.50	-0.07	120.60
33.50												
19	LAVARGE	17.18	0.19	0.00	0.002	11.412	61.01	47.76	0.00	-68.23	0.33	105.72
29.37												
21	LAVARGE	10.63	-1.22	0.00	-0.021	13.189	67.72	47.55	-0.08	-159.46	-5.20	183.18
50.88												
24	STINGER	-4.61	-5.09	0.00	0.022	15.164	83.44	47.06	-0.34	-137.29	-5.11	163.98
45.55												
26	STINGER	-11.02	-6.93	0.00	-0.005	16.602	90.11	46.84	-0.46	-48.70	-0.50	88.46
24.57												
28	STINGER	-17.40	-8.88	0.00	0.003	17.444	96.77	46.58	-0.59	-67.37	-1.18	104.15
28.93												
30	STINGER	-23.74	-10.94	0.00	-0.009	18.448	103.44	46.32	-0.73	-67.44	-3.06	104.06
28.91												
32	STINGER	-30.05	-13.10	0.00	0.082	19.263	110.11	46.04	-0.87	-45.68	10.78	86.01
23.89												
34	STINGER	-36.32	-15.36	0.00	-0.382	20.844	116.77	45.73	-1.02	-159.40	-64.21	192.03
53.34												
36	SAGEBND	-47.46	-19.81	0.17	-1.013	21.652	128.77	45.18	-1.32	22.79	0.52	64.84
18.01												

37	SAGEBEND	-58.66	-24.12	0.36	-0.879	20.462	140.77	44.62	-1.61	33.11	3.97	73.49
20.41												
38	SAGEBEND	-69.94	-28.19	0.52	-0.709	19.139	152.77	44.10	-1.88	34.24	4.03	74.08
20.58												
39	SAGEBEND	-81.33	-31.99	0.64	-0.544	17.788	164.77	43.61	-2.13	34.78	3.88	74.24
20.62												
40	SAGEBEND	-92.79	-35.52	0.73	-0.388	16.417	176.77	43.15	-2.37	35.23	3.73	74.38
20.66												
41	SAGEBEND	-104.34	-38.77	0.80	-0.239	15.028	188.77	42.74	-2.59	35.70	3.57	74.51
20.70												
42	SAGEBEND	-115.97	-41.74	0.83	-0.098	13.622	200.77	42.35	-2.78	36.21	3.38	74.62
20.73												
43	SAGEBEND	-127.67	-44.42	0.84	0.033	12.194	212.77	42.01	-2.96	36.66	3.15	74.73
20.76												
44	SAGEBEND	-139.43	-46.81	0.82	0.154	10.753	224.77	41.70	-3.12	37.02	2.91	74.81
20.78												
45	SAGEBEND	-151.24	-48.90	0.77	0.264	9.298	236.77	41.43	-3.26	37.30	2.66	74.85
20.79												
46	SAGEBEND	-163.11	-50.69	0.71	0.363	7.831	248.77	41.21	-3.38	37.55	2.42	74.87
20.80												
47	SAGEBEND	-175.02	-52.17	0.62	0.453	6.355	260.77	41.02	-3.48	37.78	2.21	74.87
20.80												
48	SAGEBEND	-186.96	-53.34	0.52	0.536	4.867	272.77	40.87	-3.55	38.00	2.13	74.84
20.79												
49	SAGEBEND	-198.93	-54.20	0.40	0.617	3.372	284.77	40.76	-3.61	38.14	2.11	74.77
20.77												
50	SAGEBEND	-210.91	-54.75	0.26	0.695	1.880	296.77	40.69	-3.65	37.74	1.79	74.27
20.63												
51	SAGEBEND	-222.91	-54.99	0.11	0.706	0.483	308.77	40.65	-3.66	29.72	-4.71	67.66
18.80												
52	SEABED	-234.91	-55.03	0.01	0.189	0.006	320.77	40.65	-3.66	2.14	-14.09	54.40
15.11												
53	SEABED	-246.91	-55.02	0.00	0.000	-0.001	332.77	40.65	-3.66	-0.08	-0.67	43.13
11.98												
54	SEABED	-258.91	-55.02	0.00	0.000	0.000	344.77	40.65	-3.66	0.00	0.04	42.63
11.84												
55	SEABED	-270.91	-55.02	0.00	0.000	0.000	356.77	40.65	-3.66	0.00	0.00	42.61
11.83												
56	SEABED	-282.91	-55.02	0.00	0.000	0.000	368.77	40.65	-3.66	0.00	0.00	42.60
11.83												
57	SEABED	-294.91	-55.02	0.00	0.000	0.000	380.77	40.65	-3.66	0.00	0.00	42.60
11.83												
58	SEABED	-306.91	-55.02	0.00	0.000	0.000	392.77	40.65	-3.66	0.00	0.00	42.60
11.83												
59	SEABED	-318.91	-55.02	0.00	0.000	0.000	404.77	40.65	-3.66	0.00	0.00	42.60
11.83												

NODE BEFORE NO. YIELD (PCT)	PIPE SECTION	X COORD (M)	Y COORD (M)	Z COORD (M)	HORIZ ANGLE (DEG)	VERT ANGLE (DEG)	PIPE LENGTH (M)	TENSILE STRESS (MEA)	HOOP STRESS (MEA)	BENDING VERT (MEA)	SIRESS HORIZ (MEA)	TOTAL STRESS (MEA)
1	TENSIONR	77.79	6.22	0.00	0.000	0.317	0.00	56.86	0.00	0.00	0.00	56.86
15.80												
3	LAYBARGE	71.49	6.16	0.00	0.000	0.957	6.30	56.84	0.00	-109.03	0.00	149.51
41.53												
5	LAYBARGE	65.38	5.99	0.00	0.000	2.219	12.42	56.82	0.00	-78.84	0.00	123.83
34.40												
7	LAYBARGE	59.91	5.73	0.00	0.000	3.298	17.89	56.78	0.00	-89.84	0.00	133.14
36.98												
9	LAYBARGE	53.32	5.28	0.00	0.000	4.482	24.49	56.71	0.00	-86.49	0.00	130.23
36.17												
11	LAYBARGE	47.32	4.74	0.00	0.000	5.786	30.51	56.62	0.00	-107.23	0.00	147.76
41.05												
13	LAYBARGE	38.21	3.70	0.00	0.000	7.419	39.68	56.45	0.00	-129.86	0.00	166.83
46.34												
15	LAYBARGE	29.27	2.39	0.00	0.000	9.059	48.72	56.25	0.00	-106.25	0.01	146.56
40.71												
17	LAYBARGE	23.13	1.34	0.00	0.000	10.379	54.95	56.09	0.00	-87.70	-0.06	130.63
36.29												
19	LAYBARGE	17.18	0.19	0.00	0.001	11.409	61.01	55.91	0.00	-69.90	0.26	115.30
32.03												
21	LAYBARGE	10.63	-1.22	0.00	-0.020	13.213	67.72	55.70	-0.08	-168.89	-4.98	199.35
55.38												
24	STINGER	-4.64	-5.13	0.00	0.011	15.779	83.47	55.18	-0.34	-212.96	-6.32	236.44
65.68												
26	STINGER	-11.01	-7.10	0.00	0.034	18.270	90.14	54.96	-0.47	-106.53	6.71	145.90
40.53												
28	STINGER	-17.30	-9.29	0.00	-0.179	20.014	96.81	54.67	-0.62	-121.98	-35.10	162.45
45.13												
30	STINGER	-23.54	-11.65	0.05	-0.752	21.285	103.47	54.38	-0.78	-51.75	-35.11	107.82
29.95												
32	STINGER	-29.74	-14.09	0.15	-1.046	21.408	110.14	54.07	-0.94	16.98	-1.84	68.68
19.08												
34	STINGER	-35.96	-16.50	0.27	-1.013	20.905	116.81	53.76	-1.10	26.43	2.99	76.63
21.29												
36	SAGEBEND	-47.21	-20.67	0.45	-0.866	19.816	128.81	53.22	-1.38	28.41	3.63	78.00
21.67												
37	SAGEBEND	-58.53	-24.63	0.61	-0.717	18.693	140.81	52.71	-1.64	28.87	3.56	78.06
21.68												
38	SAGEBEND	-69.94	-28.36	0.74	-0.572	17.552	152.81	52.23	-1.89	29.22	3.45	78.05
21.68												
39	SAGEBEND	-81.41	-31.87	0.84	-0.434	16.400	164.81	51.78	-2.12	29.57	3.30	78.05
21.68												
40	SAGEBEND	-92.96	-35.14	0.91	-0.302	15.234	176.81	51.35	-2.34	29.91	3.17	78.06
21.68												
41	SAGEBEND	-104.57	-38.17	0.96	-0.176	14.054	188.81	50.96	-2.55	30.24	3.05	78.06
21.68												
42	SAGEBEND	-116.24	-40.96	0.98	-0.056	12.862	200.81	50.60	-2.73	30.59	2.90	78.08
21.69												
43	SAGEBEND	-127.97	-43.51	0.98	0.056	11.659	212.81	50.28	-2.90	30.90	2.73	78.08
21.69												
44	SAGEBEND	-139.74	-45.81	0.96	0.161	10.444	224.81	49.98	-3.05	31.16	2.53	78.06
21.68												
45	SAGEBEND	-151.57	-47.86	0.92	0.258	9.220	236.81	49.72	-3.19	31.37	2.34	78.03
21.68												
46	SAGEBEND	-163.43	-49.66	0.86	0.346	7.989	248.81	49.49	-3.31	31.53	2.14	78.00
21.67												

47	SAGEBND	-175.33	-51.20	0.77	0.427	6.749	260.81	49.29	-3.41	31.68	1.95	77.96
21.66												
48	SAGEBND	-187.26	-52.48	0.68	0.500	5.503	272.81	49.13	-3.50	31.84	1.82	77.92
21.64												
49	SAGEBND	-199.22	-53.50	0.57	0.569	4.252	284.81	49.00	-3.56	31.98	1.77	77.86
21.63												
50	SAGEBND	-211.19	-54.25	0.44	0.637	2.996	296.81	48.90	-3.61	32.08	1.76	77.78
21.61												
51	SAGEBND	-223.18	-54.75	0.30	0.704	1.741	308.81	48.84	-3.65	31.93	1.60	77.50
21.53												
52	SAGEBND	-235.18	-54.99	0.15	0.735	0.534	320.81	48.81	-3.66	27.42	-2.03	73.71
20.47												
53	SEABED	-247.18	-55.02	0.03	0.328	0.018	332.81	48.80	-3.66	3.04	-14.34	62.95
17.49												
54	SEABED	-259.18	-55.02	0.00	0.013	-0.001	344.81	48.80	-3.66	-0.02	-1.97	52.36
14.55												
55	SEABED	-271.18	-55.02	0.00	0.000	0.000	356.81	48.80	-3.66	-0.01	0.01	50.74
14.09												
56	SEABED	-283.18	-55.02	0.00	0.000	0.000	368.81	48.80	-3.66	0.00	0.00	50.74
14.09												
57	SEABED	-295.18	-55.02	0.00	0.000	0.000	380.81	48.80	-3.66	0.00	0.00	50.73
14.09												
58	SEABED	-307.18	-55.02	0.00	0.000	0.000	392.81	48.80	-3.66	0.00	0.00	50.73
14.09												
59	SEABED	-319.18	-55.02	0.00	0.000	0.000	404.81	48.80	-3.66	0.00	0.00	50.74
14.09												

OFFPIPE - OFFSHORE PIPELINE ANALYSIS SYSTEM - VERSION 2.05 AC DATE - 5/ 6/2020 TIME - 21: 6:22 PAGE 106
PROJECT - TUGAS AKHIR JOB NO. - ANALISIS DINAMIS
USER ID - IDA ERGUS PUNDHARA SAKYANARY LICENSED TO: RICKY TAWEKAL CASE 6

NODE BERONT NO. YIELD (PCT)	PIPE SECTION	X	Y	Z	HORIZ	VERT	PIPE	TENSILE	HOOP	BENDING STRESSES		TOTAL
		COORD (M)	COORD (M)	COORD (M)	ANGLE (DEG)	ANGLE (DEG)	LENGIH (M)	STRESS (MPA)	STRESS (MPA)	VERT (MPA)	HORIZ (MPA)	STRESS (MPA)
1	TENSIONR	77.79	6.21	0.00	0.000	0.318	0.00	56.87	0.00	0.00	0.00	56.87
15.80												
3	LAVARGE	71.49	6.16	0.00	0.000	0.958	6.30	56.85	0.00	-109.03	0.00	149.52
41.53												
5	LAVARGE	65.38	5.98	0.00	0.000	2.220	12.42	56.82	0.00	-78.84	0.00	123.83
34.40												

7	LAYARGE	59.91	5.72	0.00	0.000	3.299	17.89	56.78	0.00	-89.84	0.00	133.14
36.98												
9	LAYARGE	53.32	5.27	0.00	0.000	4.483	24.49	56.71	0.00	-86.50	0.00	130.22
36.17												
11	LAYARGE	47.32	4.74	0.00	0.000	5.786	30.51	56.62	0.00	-107.23	0.00	147.76
41.04												
13	LAYARGE	38.21	3.69	0.00	0.000	7.420	39.68	56.45	0.00	-129.86	0.00	166.83
46.34												
15	LAYARGE	29.27	2.39	0.00	0.000	9.059	48.72	56.25	0.00	-106.26	0.01	146.56
40.71												
17	LAYARGE	23.13	1.33	0.00	0.000	10.380	54.95	56.09	0.00	-87.66	-0.06	130.60
36.28												
19	LAYARGE	17.18	0.19	0.00	0.001	11.410	61.01	55.91	0.00	-70.05	0.28	115.37
32.05												
21	LAYARGE	10.63	-1.22	0.00	-0.020	13.210	67.72	55.70	-0.08	-168.15	-5.11	198.73
55.20												
24	STINGER	-4.62	-5.11	0.00	0.022	15.356	83.45	55.20	-0.34	-167.60	-4.94	197.89
54.97												
26	STINGER	-11.02	-6.99	0.00	-0.008	17.152	90.12	54.98	-0.47	-67.93	-1.08	112.95
31.37												
28	STINGER	-17.37	-9.02	0.00	0.015	18.324	96.78	54.72	-0.60	-91.53	1.47	132.81
36.89												
30	STINGER	-23.67	-11.18	0.00	-0.067	19.565	103.45	54.44	-0.75	-76.24	-14.72	120.41
33.45												
32	STINGER	-29.93	-13.48	0.03	-0.569	20.622	110.12	54.14	-0.90	-71.48	-47.63	127.39
35.39												
34	STINGER	-36.16	-15.86	0.12	-0.991	20.934	116.79	53.84	-1.06	13.97	-3.86	66.23
18.40												
36	SAGEBND	-47.40	-20.06	0.31	-0.916	19.975	128.79	53.30	-1.34	27.76	3.33	77.45
21.51												
37	SAGEBND	-58.71	-24.05	0.48	-0.769	18.862	140.79	52.79	-1.60	28.80	3.56	78.01
21.67												
38	SAGEBND	-70.11	-27.81	0.62	-0.624	17.726	152.79	52.30	-1.85	29.18	3.46	78.03
21.67												
39	SAGEBND	-81.57	-31.35	0.73	-0.485	16.575	164.79	51.84	-2.09	29.52	3.32	78.04
21.68												
40	SAGEBND	-93.11	-34.66	0.81	-0.352	15.411	176.79	51.42	-2.31	29.85	3.19	78.05
21.68												
41	SAGEBND	-104.71	-37.73	0.87	-0.225	14.234	188.79	51.02	-2.52	30.19	3.07	78.08
21.69												
42	SAGEBND	-116.37	-40.56	0.90	-0.104	13.044	200.79	50.66	-2.70	30.56	2.93	78.11
21.70												
43	SAGEBND	-128.09	-43.15	0.91	0.010	11.841	212.79	50.32	-2.88	30.87	2.76	78.12
21.70												
44	SAGEBND	-139.86	-45.49	0.90	0.116	10.628	224.79	50.02	-3.03	31.13	2.57	78.11
21.70												
45	SAGEBND	-151.67	-47.57	0.87	0.213	9.405	236.79	49.75	-3.17	31.35	2.39	78.08
21.69												
46	SAGEBND	-163.53	-49.41	0.81	0.304	8.172	248.79	49.52	-3.29	31.50	2.19	78.03
21.67												
47	SAGEBND	-175.43	-50.98	0.74	0.385	6.933	260.79	49.32	-3.40	31.66	1.99	77.98
21.66												
48	SAGEBND	-187.35	-52.30	0.65	0.459	5.689	272.79	49.15	-3.49	31.82	1.84	77.93
21.65												
49	SAGEBND	-199.31	-53.36	0.55	0.528	4.438	284.79	49.01	-3.56	31.98	1.78	77.87
21.63												
50	SAGEBND	-211.28	-54.16	0.43	0.597	3.182	296.79	48.91	-3.61	32.09	1.78	77.79
21.61												
51	SAGEBND	-223.27	-54.69	0.30	0.664	1.926	308.79	48.84	-3.64	31.99	1.66	77.58
21.55												
52	SAGEBND	-235.26	-54.97	0.16	0.703	0.700	320.79	48.81	-3.66	29.08	-1.22	75.05
20.85												
53	SEABED	-247.26	-55.02	0.03	0.376	0.034	332.79	48.80	-3.66	4.70	-13.96	62.92
17.48												
54	SEABED	-259.26	-55.02	0.00	0.019	-0.001	344.79	48.80	-3.66	0.04	-2.58	52.76
14.66												
55	SEABED	-271.26	-55.02	0.00	-0.001	0.000	356.79	48.80	-3.66	-0.01	-0.02	50.75
14.10												
56	SEABED	-283.26	-55.02	0.00	0.000	0.000	368.79	48.80	-3.66	0.00	0.00	50.74
14.09												

57	SEABED	-295.26	-55.02	0.00	0.000	0.000	380.79	48.80	-3.66	0.00	0.00	50.73
14.09												
58	SEABED	-307.26	-55.02	0.00	0.000	0.000	392.79	48.80	-3.66	0.00	0.00	50.73
14.09												
59	SEABED	-319.26	-55.02	0.00	0.000	0.000	404.79	48.80	-3.66	0.00	0.00	50.73
14.09												
60	SEABED	-331.26	-55.02	0.00	0.000	0.000	416.79	48.80	-3.66	0.00	0.00	50.73
14.09												

OFFPIPE - OFFSHORE PIPELINE ANALYSIS SYSTEM - VERSION 2.05 AC DATE - 5/ 6/2020 TIME - 21: 6:22 PAGE 106
 PROJECT - TUGAS AKHIR JOB NO. - ANALISIS DINAMIS
 USER ID - IDA BAGUS PUNDHARA SAKYANARY LICENSED TO: RICKY TAWEKAL CASE 7

NODE NO.	PIPE SECTION	X	Y	Z	HORIZ	VERT	PIPE	TENSILE	HOOP	BENDING STRESSES		TOTAL
		COORD	COORD	COORD	ANGLE	ANGLE	LENGIH	STRESS	STRESS	VERT	HORIZ	STRESS
		(M)	(M)	(M)	(DEG)	(DEG)	(M)	(MPA)	(MPA)	(MPA)	(MPA)	(MPA)
YIELD (PCT)												
1	TENSIONR	77.79	6.21	0.00	0.000	0.319	0.00	56.87	0.00	0.00	0.00	56.87
15.80												
3	LAYBARGE	71.49	6.16	0.00	0.000	0.959	6.30	56.85	0.00	-109.05	0.00	149.54
41.54												
5	LAYBARGE	65.37	5.98	0.00	0.000	2.221	12.42	56.83	0.00	-78.85	0.00	123.85
34.40												
7	LAYBARGE	59.91	5.72	0.00	0.000	3.300	17.89	56.79	0.00	-89.85	0.00	133.17
36.99												
9	LAYBARGE	53.32	5.27	0.00	0.000	4.484	24.49	56.72	0.00	-86.51	0.00	130.25
36.18												
11	LAYBARGE	47.32	4.74	0.00	0.000	5.788	30.51	56.63	0.00	-107.25	0.00	147.79
41.05												
13	LAYBARGE	38.21	3.69	0.00	0.000	7.421	39.68	56.46	0.00	-129.89	0.00	166.86
46.35												
15	LAYBARGE	29.27	2.39	0.00	0.000	9.061	48.72	56.26	0.00	-106.27	0.01	146.59
40.72												
17	LAYBARGE	23.13	1.33	0.00	0.000	10.381	54.95	56.10	0.00	-87.67	-0.06	130.61
36.28												
19	LAYBARGE	17.18	0.18	0.00	0.001	11.412	61.01	55.92	0.00	-70.11	0.28	115.44
32.07												
21	LAYBARGE	10.63	-1.23	0.00	-0.020	13.210	67.72	55.71	-0.08	-167.86	-5.10	198.49
55.14												
24	STRINGER	-4.61	-5.09	0.00	0.021	15.145	83.44	55.21	-0.34	-144.83	-5.04	178.55
49.60												

26	STINGER	-11.02	-6.94	0.00	-0.004	16.604	90.11	54.99	-0.46	-50.01	-0.39	97.72
27.14												
28	STINGER	-17.40	-8.88	0.00	-0.001	17.446	96.77	54.74	-0.59	-69.79	-1.93	114.37
31.77												
30	STINGER	-23.74	-10.94	0.00	0.011	18.441	103.44	54.48	-0.73	-68.28	1.09	112.85
31.35												
32	STINGER	-30.05	-13.10	0.00	-0.051	19.316	110.11	54.20	-0.87	-55.28	-11.92	102.29
28.41												
34	STINGER	-36.32	-15.35	0.02	-0.538	20.195	116.77	53.90	-1.02	-71.57	-49.02	127.92
35.53												
36	SAGEBEND	-47.57	-19.53	0.20	-0.940	20.076	128.77	53.37	-1.30	23.73	1.21	73.81
20.50												
37	SAGEBEND	-58.87	-23.55	0.37	-0.817	19.008	140.77	52.85	-1.57	28.60	3.47	77.83
21.62												
38	SAGEBEND	-70.26	-27.34	0.52	-0.672	17.876	152.77	52.36	-1.82	29.16	3.48	78.05
21.68												
39	SAGEBEND	-81.71	-30.91	0.64	-0.532	16.726	164.77	51.90	-2.06	29.51	3.35	78.08
21.69												
40	SAGEBEND	-93.24	-34.25	0.73	-0.398	15.563	176.77	51.47	-2.28	29.83	3.21	78.10
21.69												
41	SAGEBEND	-104.83	-37.35	0.80	-0.270	14.387	188.77	51.07	-2.49	30.17	3.09	78.11
21.70												
42	SAGEBEND	-116.48	-40.21	0.84	-0.149	13.197	200.77	50.70	-2.68	30.50	2.95	78.11
21.70												
43	SAGEBEND	-128.20	-42.83	0.86	-0.034	11.996	212.77	50.36	-2.86	30.83	2.78	78.10
21.70												
44	SAGEBEND	-139.96	-45.20	0.86	0.073	10.784	224.77	50.05	-3.01	31.10	2.59	78.11
21.70												
45	SAGEBEND	-151.77	-47.32	0.83	0.172	9.563	236.77	49.78	-3.15	31.32	2.40	78.09
21.69												
46	SAGEBEND	-163.62	-49.18	0.79	0.263	8.333	248.77	49.54	-3.28	31.49	2.20	78.05
21.68												
47	SAGEBEND	-175.51	-50.79	0.73	0.346	7.094	260.77	49.33	-3.39	31.64	2.01	78.01
21.67												
48	SAGEBEND	-187.44	-52.15	0.65	0.421	5.849	272.77	49.16	-3.48	31.80	1.85	77.97
21.66												
49	SAGEBEND	-199.39	-53.24	0.55	0.491	4.598	284.77	49.02	-3.55	31.96	1.77	77.91
21.64												
50	SAGEBEND	-211.36	-54.07	0.44	0.559	3.343	296.77	48.92	-3.60	32.10	1.77	77.84
21.62												
51	SAGEBEND	-223.34	-54.64	0.32	0.627	2.087	308.77	48.84	-3.64	32.07	1.72	77.66
21.57												
52	SAGEBEND	-235.34	-54.95	0.18	0.681	0.850	320.77	48.80	-3.66	29.98	0.54	75.78
21.05												
53	SEABED	-247.34	-55.02	0.05	0.475	0.057	332.77	48.80	-3.66	6.97	-12.98	62.68
17.41												
54	SEABED	-259.34	-55.03	0.00	0.036	-0.001	344.77	48.80	-3.66	0.12	-4.15	54.08
15.02												
55	SEABED	-271.34	-55.02	0.00	0.000	0.000	356.77	48.80	-3.66	-0.01	-0.08	50.79
14.11												
56	SEABED	-283.34	-55.02	0.00	0.000	0.000	368.77	48.80	-3.66	0.00	0.01	50.73
14.09												
57	SEABED	-295.34	-55.02	0.00	0.000	0.000	380.77	48.80	-3.66	0.00	0.00	50.73
14.09												
58	SEABED	-307.34	-55.02	0.00	0.000	0.000	392.77	48.80	-3.66	0.00	0.00	50.73
14.09												
59	SEABED	-319.34	-55.02	0.00	0.000	0.000	404.77	48.80	-3.66	0.00	0.00	50.73
14.09												
60	SEABED	-331.34	-55.02	0.00	0.000	0.000	416.77	48.80	-3.66	0.00	0.00	50.73
14.09												

NODE BERONT NO. YIELD (ECT)	PIPE SECTION	X COORD (M)	Y COORD (M)	Z COORD (M)	HORIZ ANGLE (DEG)	VERT ANGLE (DEG)	PIPE LENGIH (M)	TENSILE STRESS (MEA)	HOOP STRESS (MEA)	BENDING VERT (MEA)	SIRESSES HORIZ (MEA)	TOTAL STRESS (MEA)
1	TENSIONR	77.79	6.21	0.00	0.000	0.321	0.00	65.03	0.00	0.00	0.00	65.03
18.06												
3	LAVARGE	71.49	6.16	0.00	0.000	0.960	6.30	65.01	0.00	-111.44	0.00	159.73
44.37												
5	LAVARGE	65.38	5.98	0.00	0.000	2.218	12.42	64.99	0.00	-80.97	0.00	133.81
37.17												
7	LAVARGE	59.91	5.72	0.00	0.000	3.301	17.89	64.95	0.00	-92.11	0.00	143.24
39.79												
9	LAVARGE	53.32	5.27	0.00	0.000	4.481	24.49	64.88	0.00	-88.84	0.00	140.39
39.00												
11	LAVARGE	47.32	4.74	0.00	0.000	5.792	30.51	64.79	0.00	-110.98	0.00	159.12
44.20												
13	LAVARGE	38.21	3.69	0.00	0.000	7.420	39.68	64.62	0.00	-135.20	0.00	179.53
49.87												
15	LAVARGE	29.27	2.39	0.00	0.000	9.054	48.72	64.42	0.00	-110.06	0.01	157.97
43.88												
17	LAVARGE	23.13	1.33	0.00	0.000	10.380	54.95	64.25	0.00	-89.90	-0.05	140.66
39.07												
19	LAVARGE	17.18	0.19	0.00	0.001	11.408	61.01	64.08	0.00	-71.59	0.22	124.89
34.69												
21	LAVARGE	10.63	-1.22	0.00	-0.019	13.239	67.72	63.86	-0.08	-178.27	-4.96	215.49
59.86												
24	STINGER	-4.64	-5.13	0.00	0.015	15.754	83.47	63.34	-0.34	-224.00	-5.91	253.97
70.55												
26	STINGER	-11.01	-7.10	0.00	0.018	18.269	90.14	63.13	-0.47	-109.40	4.95	156.41
43.45												
28	STINGER	-17.31	-9.28	0.01	-0.455	19.840	96.81	62.84	-0.62	-107.35	-63.39	168.72
46.87												
30	STINGER	-23.56	-11.60	0.10	-1.005	20.475	103.47	62.56	-0.77	8.15	-5.10	70.75
19.65												
32	STINGER	-29.81	-13.91	0.21	-1.006	20.092	110.14	62.26	-0.93	22.37	2.31	81.60
22.67												
34	STINGER	-36.08	-16.18	0.32	-0.940	19.577	116.81	61.97	-1.08	24.35	3.17	83.12
23.09												
36	SAGEBEND	-47.42	-20.10	0.49	-0.806	18.609	128.81	61.47	-1.34	24.90	3.20	83.24
23.12												
37	SAGEBEND	-58.82	-23.83	0.64	-0.676	17.628	140.81	60.98	-1.59	25.18	3.11	83.16
23.10												
38	SAGEBEND	-70.29	-27.37	0.76	-0.551	16.636	152.81	60.53	-1.83	25.44	3.02	83.08
23.08												
39	SAGEBEND	-81.82	-30.70	0.86	-0.430	15.633	164.81	60.10	-2.05	25.68	2.91	83.01
23.06												

40	SAGEBND	-93.40	-33.84	0.94	-0.314	14.620	176.81	59.70	-2.26	25.91	2.80	82.96
23.04												
41	SAGEBND	-105.04	-36.76	0.99	-0.203	13.598	188.81	59.32	-2.45	26.17	2.70	82.90
23.03												
42	SAGEBND	-116.72	-39.48	1.02	-0.097	12.567	200.81	58.97	-2.63	26.43	2.59	82.84
23.01												
43	SAGEBND	-128.46	-41.98	1.03	0.004	11.528	212.81	58.65	-2.80	26.65	2.46	82.78
23.00												
44	SAGEBND	-140.24	-44.27	1.02	0.099	10.481	224.81	58.35	-2.95	26.84	2.32	82.72
22.98												
45	SAGEBND	-152.06	-46.35	0.99	0.187	9.426	236.81	58.08	-3.09	26.99	2.15	82.64
22.96												
46	SAGEBND	-163.91	-48.20	0.94	0.269	8.365	248.81	57.85	-3.21	27.13	2.00	82.56
22.93												
47	SAGEBND	-175.80	-49.84	0.88	0.344	7.298	260.81	57.64	-3.32	27.25	1.84	82.48
22.91												
48	SAGEBND	-187.72	-51.25	0.80	0.413	6.227	272.81	57.46	-3.42	27.37	1.69	82.40
22.89												
49	SAGEBND	-199.66	-52.44	0.71	0.476	5.150	284.81	57.30	-3.49	27.48	1.58	82.34
22.87												
50	SAGEBND	-211.62	-53.40	0.60	0.536	4.070	296.81	57.18	-3.56	27.59	1.54	82.28
22.86												
51	SAGEBND	-223.60	-54.14	0.48	0.595	2.988	308.81	57.09	-3.61	27.67	1.54	82.21
22.84												
52	SAGEBND	-235.58	-54.65	0.35	0.653	1.903	320.81	57.02	-3.64	27.67	1.51	82.08
22.80												
53	SAGEBND	-247.58	-54.94	0.21	0.704	0.831	332.81	56.99	-3.66	26.30	0.70	80.89
22.47												
54	SEABED	-259.58	-55.02	0.07	0.559	0.076	344.81	56.98	-3.66	7.66	-10.88	69.58
19.33												
55	SEABED	-271.58	-55.02	0.00	0.079	0.001	356.81	56.98	-3.66	0.31	-6.99	64.55
17.93												
56	SEABED	-283.58	-55.02	0.00	0.001	0.000	368.81	56.98	-3.66	-0.01	-0.35	59.18
16.44												
57	SEABED	-295.58	-55.02	0.00	0.000	0.000	380.81	56.98	-3.66	0.00	0.00	58.90
16.36												
58	SEABED	-307.58	-55.02	0.00	0.000	0.000	392.81	56.98	-3.66	0.00	0.00	58.89
16.36												
59	SEABED	-319.58	-55.02	0.00	0.000	0.000	404.81	56.98	-3.66	0.00	0.00	58.89
16.36												
60	SEABED	-331.58	-55.02	0.00	0.000	0.000	416.81	56.98	-3.66	0.00	0.00	58.89
16.36												

NO. YIELD (PCT)	PIPE SECTION	X COORD (M)	Y COORD (M)	Z COORD (M)	HORIZ ANGLE (DEG)	VERT ANGLE (DEG)	PIPE LENGIH (M)	TENSILE SIRESS (MEA)	HOOP SIRESS (MEA)	BENDING VERT (MEA)	SIRESS HORIZ (MEA)	TOTAL SIRESS (MEA)
1	TENSIONR	77.79	6.21	0.00	0.000	0.321	0.00	65.10	0.00	0.00	0.00	65.10
18.08												
3	LAYBARGE	71.49	6.16	0.00	0.000	0.959	6.30	65.08	0.00	-111.49	0.00	159.84
44.40												
5	LAYBARGE	65.38	5.99	0.00	0.000	2.217	12.42	65.05	0.00	-81.00	0.00	133.91
37.20												
7	LAYBARGE	59.91	5.72	0.00	0.000	3.300	17.89	65.01	0.00	-92.14	0.00	143.33
39.82												
9	LAYBARGE	53.32	5.28	0.00	0.000	4.480	24.49	64.94	0.00	-88.87	0.00	140.48
39.02												
11	LAYBARGE	47.32	4.74	0.00	0.000	5.791	30.51	64.85	0.00	-111.03	0.00	159.23
44.23												
13	LAYBARGE	38.22	3.69	0.00	0.000	7.419	39.68	64.68	0.00	-135.26	0.00	179.65
49.90												
15	LAYBARGE	29.27	2.39	0.00	0.000	9.054	48.72	64.48	0.00	-110.12	0.01	158.08
43.91												
17	LAYBARGE	23.13	1.33	0.00	0.000	10.379	54.95	64.32	0.00	-89.83	-0.05	140.67
39.08												
19	LAYBARGE	17.18	0.19	0.00	0.001	11.409	61.01	64.14	0.00	-71.94	0.23	125.29
34.80												
21	LAYBARGE	10.63	-1.22	0.00	-0.019	13.229	67.72	63.93	-0.08	-176.81	-5.00	214.31
59.53												
24	STINGER	-4.62	-5.11	0.00	0.019	15.333	83.45	63.43	-0.34	-175.92	-5.04	213.16
59.21												
26	STINGER	-11.01	-6.99	0.00	-0.002	17.160	90.12	63.21	-0.47	-71.42	-0.42	124.03
34.45												
28	STINGER	-17.37	-9.02	0.00	-0.008	18.289	96.78	62.95	-0.60	-88.72	-4.42	138.44
38.46												
30	STINGER	-23.67	-11.18	0.01	-0.422	19.471	103.45	62.67	-0.75	-77.82	-48.90	140.77
39.10												
32	STINGER	-29.94	-13.44	0.09	-0.904	19.959	110.12	62.39	-0.90	-4.32	-12.44	73.65
20.46												
34	STINGER	-36.22	-15.70	0.20	-0.962	19.660	116.79	62.09	-1.05	21.54	1.71	80.43
22.34												
36	SAGEBEND	-47.55	-19.65	0.38	-0.845	18.721	128.79	61.58	-1.31	24.79	3.17	83.12
23.09												
37	SAGEBEND	-58.94	-23.40	0.53	-0.715	17.741	140.79	61.10	-1.56	25.18	3.15	83.17
23.10												
38	SAGEBEND	-70.40	-26.96	0.66	-0.589	16.751	152.79	60.64	-1.80	25.44	3.05	83.11
23.09												
39	SAGEBEND	-81.92	-30.32	0.77	-0.467	15.749	164.79	60.21	-2.02	25.68	2.94	83.06
23.07												
40	SAGEBEND	-93.50	-33.48	0.85	-0.352	14.737	176.79	59.80	-2.23	25.91	2.82	83.01
23.06												
41	SAGEBEND	-105.13	-36.42	0.91	-0.240	13.717	188.79	59.42	-2.43	26.14	2.72	82.96
23.04												
42	SAGEBEND	-116.81	-39.16	0.95	-0.134	12.689	200.79	59.07	-2.61	26.39	2.61	82.90
23.03												
43	SAGEBEND	-128.54	-41.69	0.97	-0.032	11.651	212.79	58.74	-2.78	26.64	2.49	82.85
23.01												
44	SAGEBEND	-140.32	-44.01	0.97	0.063	10.604	224.79	58.44	-2.93	26.85	2.35	82.78
23.00												

45	SAGEBND	-152.13	-46.11	0.94	0.152	9.550	236.79	58.17	-3.07	27.03	2.19	82.72
22.98												
46	SAGEBND	-163.98	-47.99	0.90	0.235	8.491	248.79	57.93	-3.20	27.17	2.03	82.65
22.96												
47	SAGEBND	-175.87	-49.65	0.85	0.311	7.426	260.79	57.72	-3.31	27.27	1.86	82.58
22.94												
48	SAGEBND	-187.78	-51.09	0.77	0.380	6.356	272.79	57.53	-3.41	27.35	1.71	82.50
22.92												
49	SAGEBND	-199.72	-52.31	0.69	0.444	5.280	284.79	57.38	-3.49	27.47	1.59	82.42
22.90												
50	SAGEBND	-211.68	-53.30	0.59	0.504	4.201	296.79	57.25	-3.55	27.58	1.55	82.35
22.87												
51	SAGEBND	-223.65	-54.07	0.48	0.563	3.119	308.79	57.15	-3.60	27.68	1.55	82.27
22.85												
52	SAGEBND	-235.64	-54.61	0.35	0.622	2.035	320.79	57.08	-3.64	27.70	1.53	82.16
22.82												
53	SAGEBND	-247.63	-54.92	0.22	0.675	0.957	332.79	57.04	-3.66	26.70	0.94	81.23
22.56												
54	SEABED	-259.63	-55.02	0.08	0.587	0.114	344.79	57.03	-3.66	10.53	-9.58	70.11
19.47												
55	SEABED	-271.63	-55.02	0.01	0.106	0.002	356.79	57.03	-3.66	0.51	-8.57	65.91
18.31												
56	SEABED	-283.63	-55.02	0.00	0.002	0.000	368.79	57.03	-3.66	-0.01	-0.50	59.34
16.48												
57	SEABED	-295.63	-55.02	0.00	0.000	0.000	380.79	57.03	-3.66	0.00	0.00	58.95
16.38												
58	SEABED	-307.63	-55.02	0.00	0.000	0.000	392.79	57.03	-3.66	0.00	0.00	58.95
16.38												
59	SEABED	-319.63	-55.02	0.00	0.000	0.000	404.79	57.03	-3.66	0.00	0.00	58.95
16.37												
60	SEABED	-331.63	-55.02	0.00	0.000	0.000	416.79	57.03	-3.66	0.00	0.00	58.95
16.37												

GRAFIK ANALISIS DINAMIS HEADING 0°

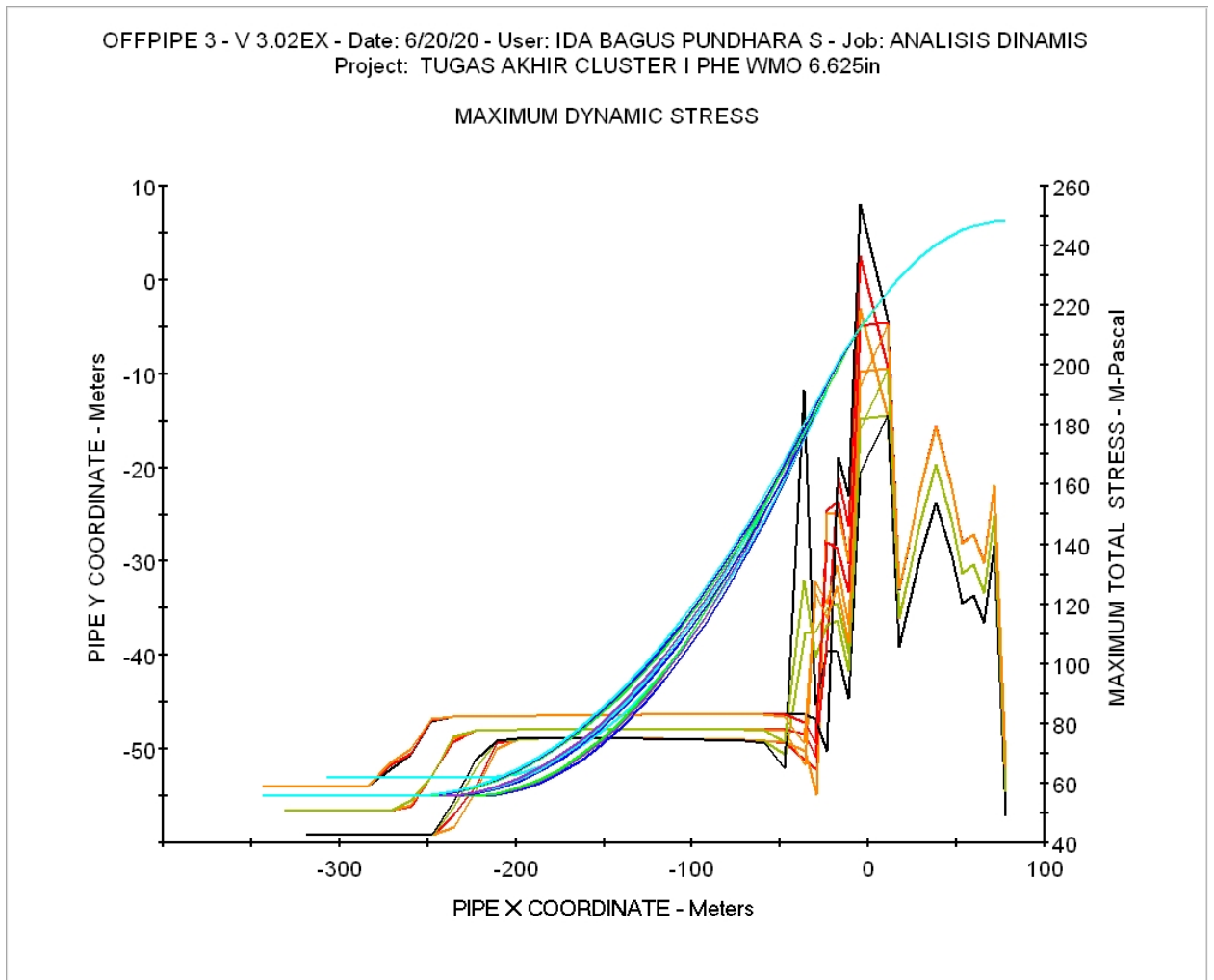

OUTPUT REGANGAN ANALISA DINAMIS HEADING 0°

SOLUTION SUMMARY										
NODE	PIPE	X	Y	Z	SUPPORT	REACT	TOTAL	TOTAL	ECT	
NO.	SECTION	COORD	COORD	COORD	VERT	HORIZ	MOMENT	STRAIN	ALL	
		(M)	(M)	(M)	(KN)	(KN)	(KN-M)	(ECT)	(%)	
1	TENSIONR	77.8	6.2	0.0	-2.6	0.0	0.0	0.017	0.	
3	LAYBRGE	71.5	6.2	0.0	23.5	0.0	47.0	0.073	0.	
5	LAYBRGE	65.4	6.0	0.0	10.1	0.0	33.8	0.051	0.	
7	LAYBRGE	59.9	5.7	0.0	14.6	0.0	38.2	0.065	0.	
9	LAYBRGE	53.3	5.3	0.0	13.1	0.0	36.8	0.063	0.	
11	LAYBRGE	47.3	4.7	0.0	17.3	0.0	42.0	0.065	0.	
13	LAYBRGE	38.2	3.7	0.0	21.6	0.0	47.5	0.072	0.	
15	LAYBRGE	29.3	2.4	0.0	17.0	0.0	41.6	0.067	0.	
17	LAYBRGE	23.1	1.3	0.0	13.7	0.0	37.4	0.066	0.	
19	LAYBRGE	17.2	0.2	0.0	8.4	0.0	32.6	0.055	0.	
21	LAYBRGE	10.6	-1.2	0.0	20.9	-1.4	54.5	0.084	0.	
24	STINGER	-4.6	-5.1	0.0	26.9	-1.2	74.1	0.102	0.	
26	STINGER	-11.0	-7.1	0.0	8.8	-1.4	47.9	0.074	0.	
28	STINGER	-17.3	-9.3	0.0	15.9	3.5	55.6	0.083	0.	
30	STINGER	-23.5	-11.7	0.0	15.5	-7.3	52.1	0.079	0.	
32	STINGER	-29.7	-14.2	0.1	7.8	-4.6	26.3	0.044	0.	
34	STINGER	-35.8	-16.9	0.2	0.0	0.0	7.9	0.026	0.	
46	SAGEND	-162.8	-51.0	0.7	0.0	0.0	23.3	0.048	0.	
50	SEABED	-210.7	-53.0	0.0	7.9	-3.8	9.0	0.023	0.	

SOLUTION SUMMARY										
NODE	PIPE	X	Y	Z	SUPPORT	REACT	TOTAL	TOTAL	ECT	
NO.	SECTION	COORD	COORD	COORD	VERT	HORIZ	MOMENT	STRAIN	ALL	
		(M)	(M)	(M)	(KN)	(KN)	(KN-M)	(ECT)	(%)	
1	TENSIONR	77.8	6.2	0.0	-2.6	0.0	0.0	0.011	0.	
3	LAYBRGE	71.5	6.2	0.0	23.5	0.0	47.0	0.072	0.	
5	LAYBRGE	65.4	6.0	0.0	10.1	0.0	33.8	0.055	0.	
7	LAYBRGE	59.9	5.7	0.0	14.6	0.0	38.2	0.061	0.	
9	LAYBRGE	53.3	5.3	0.0	13.1	0.0	36.8	0.063	0.	
11	LAYBRGE	47.3	4.7	0.0	17.2	0.0	42.0	0.069	0.	
13	LAYBRGE	38.2	3.7	0.0	21.5	0.0	47.5	0.078	0.	
15	LAYBRGE	29.3	2.4	0.0	16.9	0.0	41.6	0.065	0.	
17	LAYBRGE	23.1	1.3	0.0	13.8	0.0	37.5	0.062	0.	
19	LAYBRGE	17.2	0.2	0.0	7.9	0.0	32.1	0.055	0.	
21	LAYBRGE	10.6	-1.2	0.0	22.1	-1.4	56.3	0.083	0.	
24	STINGER	-4.6	-5.1	0.0	21.8	-1.4	56.2	0.084	0.	
26	STINGER	-11.0	-7.0	0.0	6.1	-0.4	31.5	0.052	0.	
28	STINGER	-17.4	-9.0	0.0	11.5	-0.9	37.2	0.064	0.	
30	STINGER	-23.7	-11.2	0.0	11.3	-0.4	37.1	0.065	0.	
32	STINGER	-29.9	-13.5	0.0	8.2	1.7	31.7	0.025	0.	
34	STINGER	-36.1	-15.9	0.0	16.7	-9.7	45.8	0.022	0.	
46	SAGEND	-162.9	-50.7	0.7	0.0	0.0	23.3	0.043	0.	
50	SEABED	-210.9	-53.0	0.1	6.9	-3.8	9.5	0.076	0.	

SOLUTION SUMMARY										
NODE	PIPE	X	Y	Z	SUPPORT	REACT	TOTAL	TOTAL	ECT	
NO.	SECTION	COORD	COORD	COORD	VERT	HORIZ	MOMENT	STRAIN	ALL	
		(M)	(M)	(M)	(KN)	(KN)	(KN-M)	(ECT)	(%)	

1	TENSION	77.8	6.2	0.0	-2.6	0.0	0.0	0.028	0.
3	LAYERGE	71.5	6.2	0.0	23.5	0.0	47.0	0.034	0.
5	LAYERGE	65.4	6.0	0.0	10.1	0.0	33.8	0.098	0.
7	LAYERGE	59.9	5.7	0.0	14.6	0.0	38.2	0.054	0.
9	LAYERGE	53.3	5.3	0.0	13.1	0.0	36.8	0.032	0.
11	LAYERGE	47.3	4.7	0.0	17.2	0.0	42.0	0.068	0.
13	LAYERGE	38.2	3.7	0.0	21.5	0.0	47.5	0.085	0.
15	LAYERGE	29.3	2.4	0.0	16.9	0.0	41.6	0.027	0.
17	LAYERGE	23.1	1.3	0.0	13.9	0.0	37.6	0.073	0.
19	LAYERGE	17.2	0.2	0.0	7.7	0.0	31.9	0.056	0.
21	LAYERGE	10.6	-1.2	0.0	22.7	-1.4	57.3	0.036	0.
24	SITINGER	-4.6	-5.1	0.0	19.3	-1.4	47.4	0.064	0.
26	SITINGER	-11.0	-6.9	0.0	4.5	-0.1	23.0	0.035	0.
28	SITINGER	-17.4	-8.9	0.0	10.3	-1.9	29.2	0.022	0.
30	SITINGER	-23.7	-10.9	0.0	9.1	2.1	27.1	0.059	0.
32	SITINGER	-30.0	-13.1	0.0	0.9	0.5	21.8	0.043	0.
34	SITINGER	-36.3	-15.4	0.0	32.4	-10.1	80.4	0.103	0.
46	SPEED	-163.0	-50.5	0.7	0.0	0.0	23.3	0.043	0.
50	SPEED	-210.9	-53.0	0.1	6.0	-3.4	10.2	0.067	0.

SOLUTION SUMMARY

NODE	PIPE	X	Y	Z	SUPPORT	REACT	TOTAL	TOTAL	ECT
NO.	SECTION	COORD	COORD	COORD	VERT	HORIZ	MOMENT	STRAIN	ALL
		(M)	(M)	(M)	(KN)	(KN)	(KN-M)	(ECT)	(%)
1	TENSION	77.8	6.2	0.0	-2.4	0.0	0.0	0.034	0.
3	LAYERGE	71.5	6.2	0.0	25.8	0.0	48.1	0.042	0.
5	LAYERGE	65.4	6.0	0.0	12.0	0.0	34.8	0.056	0.
7	LAYERGE	59.9	5.7	0.0	16.6	0.0	39.3	0.081	0.
9	LAYERGE	53.3	5.3	0.0	15.1	0.0	37.9	0.069	0.
11	LAYERGE	47.3	4.7	0.0	19.8	0.0	43.7	0.026	0.
13	LAYERGE	38.2	3.7	0.0	24.8	0.0	50.0	0.044	0.
15	LAYERGE	29.3	2.4	0.0	19.6	0.0	43.3	0.076	0.
17	LAYERGE	23.1	1.3	0.0	15.8	0.0	38.5	0.040	0.
19	LAYERGE	17.2	0.2	0.0	9.7	-0.1	32.9	0.083	0.
21	LAYERGE	10.6	-1.2	0.0	25.5	-1.3	59.7	0.075	0.
24	SITINGER	-4.6	-5.1	0.0	32.5	-2.4	79.9	0.109	0.
26	SITINGER	-11.0	-7.1	0.0	12.6	5.2	50.5	0.074	0.
28	SITINGER	-17.3	-9.3	0.0	21.3	-12.4	57.9	0.042	0.
30	SITINGER	-23.5	-11.6	0.1	3.5	-2.1	13.9	0.069	0.
32	SITINGER	-29.8	-14.0	0.2	0.0	0.0	8.9	0.053	0.
34	SITINGER	-36.0	-16.4	0.3	0.0	0.0	13.4	0.049	0.
47	SPEED	-175.7	-49.8	0.9	0.0	0.0	16.8	0.071	0.
52	SPEED	-235.5	-53.0	0.1	4.8	-2.9	8.8	0.052	0.

SOLUTION SUMMARY

NODE	PIPE	X	Y	Z	SUPPORT	REACT	TOTAL	TOTAL	ECT
NO.	SECTION	COORD	COORD	COORD	VERT	HORIZ	MOMENT	STRAIN	ALL
		(M)	(M)	(M)	(KN)	(KN)	(KN-M)	(ECT)	(%)
1	TENSION	77.8	6.2	0.0	-2.4	0.0	0.0	0.025	0.
3	LAYERGE	71.5	6.2	0.0	25.8	0.0	48.1	0.084	0.
5	LAYERGE	65.4	6.0	0.0	12.0	0.0	34.8	0.067	0.
7	LAYERGE	59.9	5.7	0.0	16.7	0.0	39.3	0.075	0.
9	LAYERGE	53.3	5.3	0.0	15.1	0.0	37.9	0.069	0.
11	LAYERGE	47.3	4.7	0.0	19.8	0.0	43.7	0.078	0.
13	LAYERGE	38.2	3.7	0.0	24.8	0.0	50.0	0.086	0.
15	LAYERGE	29.3	2.4	0.0	19.5	0.0	43.3	0.075	0.

17	LAYERGE	23.1	1.3	0.0	15.9	0.0	38.6	0.073	0.
19	LAYERGE	17.2	0.2	0.0	9.3	0.0	32.6	0.062	0.
21	LAYERGE	10.6	-1.2	0.0	26.5	-1.4	61.0	0.097	0.
24	SUINGER	-4.6	-5.1	0.0	26.2	-1.2	60.9	0.093	0.
26	SUINGER	-11.0	-7.0	0.0	7.3	-1.2	31.8	0.064	0.
28	SUINGER	-17.4	-9.0	0.0	15.5	2.7	40.3	0.076	0.
30	SUINGER	-23.7	-11.2	0.0	12.0	-7.0	35.3	0.063	0.
32	SUINGER	-29.9	-13.5	0.1	9.2	-5.4	23.1	0.056	0.
34	SUINGER	-36.2	-15.8	0.2	0.0	0.0	7.2	0.038	0.
47	SAGEBD	-175.8	-49.7	0.8	0.0	0.0	16.8	0.044	0.
52	SEAFBD	-235.6	-53.0	0.1	3.8	-2.3	10.1	0.033	0.

SOLUTION SUMMARY

NODE NO.	PIPE SECTION	X	Y	Z	SUPPORT	REACT	TOTAL	TOTAL	ECT ALL
		COORD (M)	COORD (M)	COORD (M)	VERT (KN)	HORIZ (KN)	MOMENT (KN-M)	STRAIN (ECT)	
1	TENSION	77.8	6.2	0.0	-2.4	0.0	0.0	0.044	0.
3	LAYERGE	71.5	6.2	0.0	25.8	0.0	48.1	0.082	0.
5	LAYERGE	65.4	6.0	0.0	12.0	0.0	34.8	0.066	0.
7	LAYERGE	59.9	5.7	0.0	16.6	0.0	39.3	0.071	0.
9	LAYERGE	53.3	5.3	0.0	15.1	0.0	37.9	0.069	0.
11	LAYERGE	47.3	4.7	0.0	19.8	0.0	43.7	0.086	0.
13	LAYERGE	38.2	3.7	0.0	24.8	0.0	50.0	0.074	0.
15	LAYERGE	29.3	2.4	0.0	19.5	0.0	43.3	0.035	0.
17	LAYERGE	23.1	1.3	0.0	15.9	0.0	38.6	0.050	0.
19	LAYERGE	17.2	0.2	0.0	9.2	0.0	32.4	0.062	0.
21	LAYERGE	10.6	-1.2	0.0	27.0	-1.4	61.7	0.085	0.
24	SUINGER	-4.6	-5.1	0.0	23.0	-1.4	51.4	0.095	0.
26	SUINGER	-11.0	-6.9	0.0	5.6	-0.4	23.4	0.041	0.
28	SUINGER	-17.4	-8.9	0.0	11.9	-1.0	30.0	0.069	0.
30	SUINGER	-23.7	-10.9	0.0	11.4	1.5	29.0	0.058	0.
32	SUINGER	-30.0	-13.1	0.0	9.4	-5.4	26.5	0.054	0.
34	SUINGER	-36.3	-15.3	0.1	9.7	-5.7	22.5	0.050	0.
45	SAGEBD	-152.1	-46.3	0.9	0.0	0.0	16.6	0.041	0.
52	SEAFBD	-235.7	-53.0	0.1	2.9	-1.7	11.6	0.035	0.

SOLUTION SUMMARY

NODE NO.	PIPE SECTION	X	Y	Z	SUPPORT	REACT	TOTAL	TOTAL	ECT ALL
		COORD (M)	COORD (M)	COORD (M)	VERT (KN)	HORIZ (KN)	MOMENT (KN-M)	STRAIN (ECT)	
1	TENSION	77.8	6.2	0.0	-2.6	0.0	0.0	0.013	0.
3	LAYERGE	71.5	6.2	0.0	23.5	0.0	47.0	0.076	0.
5	LAYERGE	65.4	6.0	0.0	10.1	0.0	33.8	0.055	0.
7	LAYERGE	59.9	5.7	0.0	14.6	0.0	38.2	0.064	0.
9	LAYERGE	53.3	5.3	0.0	13.1	0.0	36.8	0.068	0.
11	LAYERGE	47.3	4.7	0.0	17.2	0.0	42.0	0.065	0.
13	LAYERGE	38.2	3.7	0.0	21.5	0.0	47.5	0.073	0.
15	LAYERGE	29.3	2.4	0.0	17.0	0.0	41.6	0.065	0.
17	LAYERGE	23.1	1.3	0.0	13.7	0.0	37.4	0.068	0.
19	LAYERGE	17.2	0.2	0.0	8.4	0.0	32.6	0.056	0.
21	LAYERGE	10.6	-1.2	0.0	20.8	-1.4	54.4	0.084	0.
24	SUINGER	-4.6	-5.1	0.0	26.8	-1.3	74.1	0.116	0.
26	SUINGER	-11.0	-7.1	0.0	8.9	-0.8	48.0	0.073	0.
28	SUINGER	-17.3	-9.3	0.0	15.6	1.0	55.2	0.085	0.
30	SUINGER	-23.5	-11.7	0.0	14.0	-1.6	50.5	0.077	0.
32	SUINGER	-29.7	-14.3	0.0	14.3	-8.3	44.1	0.074	0.

34	SIINGER	-35.8	-17.0	0.1	0.0	0.0	4.9	0.022	0.
47	SAGEBD	-174.1	-54.5	0.6	0.0	0.0	23.5	0.044	0.
50	SEAFED	-210.0	-56.0	0.1	4.7	-2.8	12.2	0.036	0.

SOLUTION SUMMARY

NO.	PIPE SECTION	X COORD (M)	Y COORD (M)	Z COORD (M)	SUPPORT VERT (KN)	REACT HORIZ (KN)	TOTAL MOMENT (KN-M)	TOTAL STRAIN (ECT)	PCT ALL (%)
1	TENSIONR	77.8	6.2	0.0	-2.6	0.0	0.0	0.018	0.
3	LAVBRGE	71.5	6.2	0.0	23.5	0.0	47.0	0.078	0.
5	LAVBRGE	65.4	6.0	0.0	10.1	0.0	33.8	0.055	0.
7	LAVBRGE	59.9	5.7	0.0	14.6	0.0	38.2	0.066	0.
9	LAVBRGE	53.3	5.3	0.0	13.1	0.0	36.8	0.064	0.
11	LAVBRGE	47.3	4.7	0.0	17.3	0.0	42.0	0.068	0.
13	LAVBRGE	38.2	3.7	0.0	21.6	0.0	47.5	0.076	0.
15	LAVBRGE	29.3	2.4	0.0	16.9	0.0	41.6	0.064	0.
17	LAVBRGE	23.1	1.3	0.0	13.8	0.0	37.5	0.067	0.
19	LAVBRGE	17.2	0.2	0.0	7.9	0.0	32.1	0.055	0.
21	LAVBRGE	10.6	-1.2	0.0	22.1	-1.4	56.4	0.088	0.
24	SIINGER	-4.6	-5.1	0.0	21.8	-1.4	56.3	0.086	0.
26	SIINGER	-11.0	-7.0	0.0	6.0	-0.4	31.4	0.052	0.
28	SIINGER	-17.4	-9.0	0.0	11.8	-0.9	37.5	0.064	0.
30	SIINGER	-23.7	-11.2	0.0	10.7	-0.9	35.9	0.068	0.
32	SIINGER	-29.9	-13.5	0.0	7.0	4.0	33.4	0.056	0.
34	SIINGER	-36.1	-15.9	0.0	23.5	-11.6	63.1	0.124	0.
47	SAGEBD	-174.3	-54.2	0.6	0.0	0.0	23.5	0.045	0.
50	SEAFED	-210.2	-56.0	0.1	2.8	-1.7	15.7	0.037	0.

SOLUTION SUMMARY

NO.	PIPE SECTION	X COORD (M)	Y COORD (M)	Z COORD (M)	SUPPORT VERT (KN)	REACT HORIZ (KN)	TOTAL MOMENT (KN-M)	TOTAL STRAIN (ECT)	PCT ALL (%)
1	TENSIONR	77.8	6.2	0.0	-2.6	0.0	0.0	0.012	0.
3	LAVBRGE	71.5	6.2	0.0	23.5	0.0	47.0	0.074	0.
5	LAVBRGE	65.4	6.0	0.0	10.1	0.0	33.8	0.057	0.
7	LAVBRGE	59.9	5.7	0.0	14.6	0.0	38.2	0.063	0.
9	LAVBRGE	53.3	5.3	0.0	13.1	0.0	36.8	0.067	0.
11	LAVBRGE	47.3	4.7	0.0	17.2	0.0	42.0	0.063	0.
13	LAVBRGE	38.2	3.7	0.0	21.5	0.0	47.5	0.077	0.
15	LAVBRGE	29.3	2.4	0.0	16.9	0.0	41.6	0.066	0.
17	LAVBRGE	23.1	1.3	0.0	13.9	0.0	37.6	0.063	0.
19	LAVBRGE	17.2	0.2	0.0	7.7	0.0	31.9	0.057	0.
21	LAVBRGE	10.6	-1.2	0.0	22.7	-1.4	57.3	0.086	0.
24	SIINGER	-4.6	-5.1	0.0	19.3	-1.4	47.4	0.073	0.
26	SIINGER	-11.0	-6.9	0.0	4.3	-0.1	22.8	0.044	0.
28	SIINGER	-17.4	-8.9	0.0	11.3	-2.0	30.2	0.055	0.
30	SIINGER	-23.7	-10.9	0.0	7.1	2.3	23.6	0.044	0.
32	SIINGER	-30.1	-13.1	0.0	0.0	0.0	24.6	0.046	0.
34	SIINGER	-36.3	-15.4	0.0	39.0	-10.0	97.8	0.093	0.
47	SAGEBD	-174.3	-54.0	0.6	0.0	0.0	23.5	0.043	0.
51	SEAFED	-222.3	-56.0	0.0	8.2	-3.4	8.1	0.025	0.

OUTPUT ANALISA DINAMIS HEADING 45°

OFFPIPE - OFFSHORE PIPELINE ANALYSIS SYSTEM - VERSION 2.05 AC DATE - 5/ 6/2020 TIME - 21: 6:22
 PAGE 106
 PROJECT - TUGAS AKHIR JOB NO. - ANALISIS
 DINAMIS
 USER ID - IDA BAGUS HUNDHARA SAKYANARY LICENSED TO: RICKY TAWEKAL CASE
 1

NODE TOTAL NO. STRESS (MPA)	PIPE BEFON! SECTION YIELD (PCT)	X COORD (M)	Y COORD (M)	Z COORD (M)	HORIZ ANGLE (DEG)	VERT ANGLE (DEG)	PIPE LENGIH (M)	TENSILE STRESS (MPA)	HOOP STRESS (MPA)	BENDING STRESSES VERT (MPA)	HORIZ (MPA)
1	TENSIONR	77.79	6.21	0.00	0.000	0.315	0.00	48.72	0.00	0.00	0.00
48.72	13.53										
3	LAYFARGE	71.49	6.16	0.00	0.000	0.957	6.30	48.70	0.00	-106.57	0.00
139.29	38.69										
5	LAYFARGE	65.37	5.98	0.00	0.000	2.222	12.42	48.68	0.00	-76.69	0.00
113.86	31.63										
7	LAYFARGE	59.91	5.72	0.00	0.000	3.297	17.89	48.63	0.00	-87.55	0.00
123.05	34.18										
9	LAYFARGE	53.32	5.27	0.00	0.000	4.485	24.49	48.56	0.00	-84.14	0.00
120.08	33.36										
11	LAYFARGE	47.32	4.74	0.00	0.000	5.781	30.51	48.47	0.00	-103.45	0.00
136.40	37.89										
13	LAYFARGE	38.21	3.69	0.00	0.000	7.421	39.68	48.30	0.00	-124.46	0.00
154.10	42.81										
15	LAYFARGE	29.27	2.39	0.00	0.000	9.064	48.72	48.10	0.00	-102.42	0.02
135.16	37.54										
17	LAYFARGE	23.13	1.33	0.00	0.000	10.380	54.95	47.94	0.00	-85.49	-0.09
120.60	33.50										
19	LAYFARGE	17.18	0.19	0.00	0.002	11.412	61.01	47.76	0.00	-68.31	0.39
105.73	29.37										
21	LAYFARGE	10.63	-1.22	0.00	-0.022	13.187	67.72	47.55	-0.08	-159.15	-5.47
182.94	50.82										
24	STINGER	-4.64	-5.13	0.00	0.026	15.810	83.47	47.04	-0.34	-202.00	-4.84
218.95	60.82										
26	STINGER	-11.01	-7.10	0.00	-0.021	18.258	90.14	46.81	-0.47	-101.57	-3.16
133.41	37.06										
28	STINGER	-17.30	-9.29	0.00	0.072	20.060	96.81	46.53	-0.62	-125.96	10.99
154.27	42.85										
30	STINGER	-23.53	-11.68	0.00	-0.320	21.939	103.47	46.22	-0.78	-109.93	-57.57
151.47	42.08										
32	STINGER	-29.68	-14.23	0.08	-0.970	22.820	110.14	45.90	-0.95	-12.73	-17.79
64.76	17.99										
34	STINGER	-35.83	-16.81	0.19	-1.093	22.536	116.81	45.57	-1.12	25.78	1.07
67.60	18.78										
36	SAGEEND	-46.96	-21.30	0.39	-0.951	21.325	128.81	44.99	-1.42	32.87	4.12
73.59	20.44										
37	SAGEEND	-58.19	-25.54	0.56	-0.777	20.018	140.81	44.45	-1.70	33.82	4.17
74.05	20.57										
38	SAGEEND	-69.51	-29.51	0.70	-0.607	18.683	152.81	43.93	-1.97	34.35	4.02
74.20	20.61										
39	SAGEEND	-80.92	-33.22	0.80	-0.445	17.327	164.81	43.45	-2.22	34.87	3.84
74.31	20.64										
40	SAGEEND	-92.42	-36.66	0.88	-0.291	15.950	176.81	43.01	-2.44	35.40	3.69
74.45	20.68										

41	SAGEEND	-103.99	-39.81	0.92	-0.144	14.553	188.81	42.60	-2.65	35.88	3.51
74.57	20.71										
42	SAGEEND	-115.64	-42.69	0.93	-0.007	13.138	200.81	42.23	-2.85	36.37	3.30
74.69	20.75										
43	SAGEEND	-127.36	-45.27	0.92	0.121	11.706	212.81	41.90	-3.02	36.79	3.07
74.77	20.77										
44	SAGEEND	-139.14	-47.55	0.89	0.237	10.258	224.81	41.61	-3.17	37.11	2.83
74.80	20.78										
45	SAGEEND	-150.98	-49.54	0.83	0.344	8.798	236.81	41.35	-3.30	37.37	2.57
74.82	20.78										
46	SAGEEND	-162.86	-51.22	0.74	0.441	7.328	248.81	41.14	-3.41	37.63	2.33
74.82	20.78										
47	SAGEEND	-174.78	-52.60	0.64	0.528	5.848	260.81	40.96	-3.51	37.87	2.17
74.82	20.78										
48	SAGEEND	-186.73	-53.67	0.52	0.610	4.359	272.81	40.82	-3.58	38.08	2.11
74.79	20.78										
49	SAGEEND	-198.70	-54.42	0.39	0.691	2.862	284.81	40.73	-3.63	38.16	2.07
74.68	20.74										
50	SAGEEND	-210.69	-54.87	0.24	0.762	1.379	296.81	40.67	-3.66	36.78	1.25
73.41	20.39										
51	SEALED	-222.69	-55.02	0.08	0.662	0.175	308.81	40.65	-3.66	16.96	-11.54
59.20	16.44										
52	SEALED	-234.69	-55.03	0.00	0.083	-0.002	320.81	40.65	-3.66	0.43	-8.41
49.56	13.77										
53	SEALED	-246.69	-55.02	0.00	-0.001	0.000	332.81	40.65	-3.66	-0.04	-0.16
42.72	11.87										
54	SEALED	-258.69	-55.02	0.00	0.000	0.000	344.81	40.65	-3.66	0.00	0.02
42.62	11.84										
55	SEALED	-270.69	-55.02	0.00	0.000	0.000	356.81	40.65	-3.66	0.00	0.00
42.60	11.83										
56	SEALED	-282.69	-55.02	0.00	0.000	0.000	368.81	40.65	-3.66	0.00	0.00
42.60	11.83										
57	SEALED	-294.69	-55.02	0.00	0.000	0.000	380.81	40.65	-3.66	0.00	0.00
42.60	11.83										
58	SEALED	-306.69	-55.02	0.00	0.000	0.000	392.81	40.65	-3.66	0.00	0.00
42.60	11.83										

NODE TOTAL NO. STRESS (MPA)	PIPE BEFORE SECTION YIELD (PCT)	X COORD (M)	Y COORD (M)	Z COORD (M)	HORIZ ANGLE (DEG)	VERT ANGLE (DEG)	PIPE LENGTH (M)	TENSILE STRESS (MPA)	HOOP STRESS (MPA)	BENDING VERT (MPA)	STRESSES HORIZ (MPA)
1	TENSIONR	77.79	6.21	0.00	0.000	0.313	0.00	48.73	0.00	0.00	0.00
48.73	13.54										
3	LAYARGE	71.49	6.16	0.00	0.000	0.955	6.30	48.71	0.00	-106.61	0.00
139.33	38.70										
5	LAYARGE	65.38	5.99	0.00	0.000	2.220	12.42	48.69	0.00	-76.71	0.00
113.89	31.64										
7	LAYARGE	59.91	5.72	0.00	0.000	3.295	17.89	48.65	0.00	-87.57	0.00
123.08	34.19										
9	LAYARGE	53.32	5.28	0.00	0.000	4.483	24.49	48.58	0.00	-84.16	0.00
120.12	33.37										
11	LAYARGE	47.32	4.74	0.00	0.000	5.779	30.51	48.49	0.00	-103.48	0.00
136.44	37.90										
13	LAYARGE	38.21	3.69	0.00	0.000	7.419	39.68	48.32	0.00	-124.50	0.00
154.15	42.82										
15	LAYARGE	29.27	2.39	0.00	0.000	9.062	48.72	48.12	0.00	-102.44	0.02
135.19	37.55										
17	LAYARGE	23.13	1.33	0.00	0.000	10.378	54.95	47.95	0.00	-85.49	-0.08
120.62	33.51										
19	LAYARGE	17.18	0.19	0.00	0.002	11.410	61.01	47.77	0.00	-68.31	0.37
105.78	29.38										
21	LAYARGE	10.63	-1.22	0.00	-0.021	13.186	67.72	47.57	-0.08	-159.18	-5.43
182.98	50.83										
24	STINGER	-4.64	-5.13	0.00	0.023	15.807	83.47	47.05	-0.34	-201.82	-5.24
218.82	60.78										
26	STINGER	-11.01	-7.10	0.00	-0.009	18.261	90.14	46.83	-0.47	-102.46	-1.43
134.15	37.27										
28	STINGER	-17.31	-9.29	0.00	0.021	20.036	96.81	46.54	-0.62	-122.04	3.17
150.56	41.82										
30	STINGER	-23.53	-11.67	0.01	-0.490	21.821	103.47	46.23	-0.78	-105.56	-61.35
150.21	41.72										
32	STINGER	-29.70	-14.21	0.11	-1.084	22.473	110.14	45.92	-0.95	10.13	-6.53
56.21	15.61										
34	STINGER	-35.87	-16.73	0.23	-1.097	21.992	116.81	45.59	-1.12	28.94	2.61
70.57	19.60										
36	SAGEEND	-47.04	-21.11	0.43	-0.935	20.741	128.81	45.03	-1.41	33.13	4.25
73.87	20.52										
37	SAGEEND	-58.31	-25.23	0.59	-0.760	19.426	140.81	44.49	-1.68	33.87	4.23
74.17	20.60										
38	SAGEEND	-69.67	-29.08	0.73	-0.590	18.086	152.81	44.00	-1.94	34.41	4.08
74.32	20.64										
39	SAGEEND	-81.12	-32.67	0.83	-0.427	16.725	164.81	43.53	-2.18	34.90	3.91
74.45	20.68										
40	SAGEEND	-92.65	-35.99	0.90	-0.272	15.345	176.81	43.10	-2.40	35.41	3.78
74.58	20.72										
41	SAGEEND	-104.26	-39.02	0.94	-0.124	13.946	188.81	42.71	-2.60	35.93	3.65
74.72	20.76										
42	SAGEEND	-115.94	-41.77	0.95	0.015	12.529	200.81	42.36	-2.79	36.38	3.49
74.83	20.78										
43	SAGEEND	-127.69	-44.23	0.93	0.146	11.098	212.81	42.04	-2.95	36.76	3.29
74.89	20.80										
44	SAGEEND	-139.49	-46.39	0.89	0.268	9.652	224.81	41.77	-3.09	37.06	3.11
74.95	20.82										
45	SAGEEND	-151.34	-48.25	0.82	0.380	8.194	236.81	41.53	-3.22	37.32	2.94
74.97	20.83										
46	SAGEEND	-163.24	-49.81	0.73	0.484	6.726	248.81	41.33	-3.32	37.55	2.79
74.96	20.82										
47	SAGEEND	-175.18	-51.06	0.62	0.579	5.247	260.81	41.17	-3.40	37.76	2.68
74.93	20.81										
48	SAGEEND	-187.14	-52.00	0.49	0.668	3.762	272.81	41.05	-3.47	37.94	2.60
74.86	20.79										

49	SAGEBD	-199.12	-52.64	0.35	0.749	2.275	284.81	40.97	-3.51	37.87	2.40
74.59	20.72										
50	SAGEBD	-211.11	-52.96	0.18	0.799	0.826	296.81	40.92	-3.53	34.18	-1.75
71.44	19.84										
51	SEABD	-223.11	-53.02	0.04	0.452	0.032	308.81	40.92	-3.53	5.46	-16.58
57.07	15.85										
52	SEABD	-235.11	-53.03	0.00	0.018	-0.002	320.81	40.92	-3.53	-0.07	-3.38
45.50	12.64										
53	SEABD	-247.11	-53.02	0.00	-0.001	0.000	332.81	40.92	-3.53	-0.01	0.05
42.83	11.90										
54	SEABD	-259.11	-53.02	0.00	0.000	0.000	344.81	40.92	-3.53	0.00	0.01
42.80	11.89										
55	SEABD	-271.11	-53.02	0.00	0.000	0.000	356.81	40.92	-3.53	0.00	0.00
42.79	11.89										
56	SEABD	-283.11	-53.02	0.00	0.000	0.000	368.81	40.92	-3.53	0.00	0.00
42.79	11.89										
57	SEABD	-295.11	-53.02	0.00	0.000	0.000	380.81	40.92	-3.53	0.00	0.00
42.79	11.89										
58	SEABD	-307.11	-53.02	0.00	0.000	0.000	392.81	40.92	-3.53	0.00	0.00
42.79	11.89										

OFFPIPE - OFFSHORE PIPELINE ANALYSIS SYSTEM - VERSION 2.05 AC DATE - 5/ 6/2020 TIME - 21: 6:22
PAGE 106
PROJECT - TUGAS AKHIR JOB NO. - ANALISIS
DINPMIS
USER ID - IDA BAGUS PUNDHARA SARYANARY LICENSED TO: RICKY TAMEKAL CASE
3

NODE	PIPE	X	Y	Z	HORIZ	VERT	PIPE	TENSILE	HOOP	BENDING	SIRESSSES
TOTAL	PERCENT										
NO.	SECTION	COORD	COORD	COORD	ANGLE	ANGLE	LENGIH	SIRESS	SIRESS	VERT	HORIZ
SIRESS	YIELD	(M)	(M)	(M)	(DEG)	(DEG)	(M)	(MPA)	(MPA)	(MPA)	(MPA)
(MPA)	(PCT)										
1	TENSIONR	77.79	6.21	0.00	0.000	0.315	0.00	48.76	0.00	0.00	0.00
48.76	13.54										
3	LAYARGE	71.49	6.16	0.00	0.000	0.956	6.30	48.74	0.00	-106.61	0.00
139.34	38.71										
5	LAYARGE	65.38	5.98	0.00	0.000	2.222	12.42	48.71	0.00	-76.71	0.00
113.91	31.64										

7	LAYARGE	59.91	5.72	0.00	0.000	3.296	17.89	48.67	0.00	-87.57	0.00
123.10	34.19										
9	LAYARGE	53.32	5.27	0.00	0.000	4.485	24.49	48.60	0.00	-84.16	0.00
120.13	33.37										
11	LAYARGE	47.32	4.74	0.00	0.000	5.781	30.51	48.51	0.00	-103.48	0.00
136.46	37.91										
13	LAYARGE	38.22	3.69	0.00	0.000	7.420	39.68	48.34	0.00	-124.51	0.00
154.16	42.82										
15	LAYARGE	29.27	2.39	0.00	0.000	9.064	48.72	48.14	0.00	-102.44	0.02
135.21	37.56										
17	LAYARGE	23.13	1.33	0.00	0.000	10.380	54.95	47.98	0.00	-85.51	-0.08
120.65	33.51										
19	LAYARGE	17.18	0.19	0.00	0.002	11.411	61.01	47.80	0.00	-68.27	0.36
105.74	29.37										
21	LAYARGE	10.63	-1.22	0.00	-0.021	13.189	67.72	47.59	-0.08	-159.39	-5.39
183.18	50.88										
24	STINGER	-4.62	-5.11	0.00	0.022	15.377	83.45	47.09	-0.34	-158.82	-5.35
182.31	50.64										
26	STINGER	-11.01	-6.99	0.00	-0.004	17.153	90.12	46.87	-0.47	-66.45	-0.27
103.58	28.77										
28	STINGER	-17.37	-9.02	0.00	-0.004	18.311	96.78	46.60	-0.60	-86.34	-2.37
120.32	33.42										
30	STINGER	-23.67	-11.19	0.00	0.021	19.623	103.45	46.32	-0.75	-84.17	2.84
118.26	32.85										
32	STINGER	-29.93	-13.49	0.00	-0.096	20.828	110.12	46.03	-0.90	-73.60	-19.52
110.68	30.74										
34	STINGER	-36.14	-15.92	0.03	-0.626	21.815	116.79	45.72	-1.06	-61.61	-43.62
110.22	30.62										
36	SAGEEND	-47.27	-20.40	0.22	-1.000	21.540	128.79	45.14	-1.36	28.19	1.79
69.41	19.28										
37	SAGEEND	-58.47	-24.69	0.40	-0.853	20.288	140.79	44.59	-1.65	33.45	4.07
73.75	20.49										
38	SAGEEND	-69.78	-28.72	0.55	-0.682	18.959	152.79	44.07	-1.91	34.27	4.05
74.11	20.59										
39	SAGEEND	-81.17	-32.48	0.67	-0.518	17.607	164.79	43.58	-2.17	34.78	3.88
74.26	20.63										
40	SAGEEND	-92.65	-35.97	0.76	-0.363	16.234	176.79	43.13	-2.40	35.27	3.72
74.43	20.68										
41	SAGEEND	-104.21	-39.19	0.82	-0.215	14.841	188.79	42.72	-2.61	35.79	3.54
74.59	20.72										
42	SAGEEND	-115.85	-42.12	0.85	-0.076	13.431	200.79	42.34	-2.81	36.26	3.35
74.71	20.75										
43	SAGEEND	-127.55	-44.76	0.85	0.054	12.000	212.79	42.00	-2.98	36.70	3.12
74.81	20.78										
44	SAGEEND	-139.32	-47.11	0.83	0.173	10.558	224.79	41.70	-3.14	37.05	2.87
74.87	20.80										
45	SAGEEND	-151.14	-49.16	0.78	0.282	9.100	236.79	41.43	-3.28	37.35	2.61
74.89	20.80										
46	SAGEEND	-163.01	-50.90	0.71	0.381	7.632	248.79	41.21	-3.39	37.59	2.36
74.91	20.81										
47	SAGEEND	-174.93	-52.34	0.62	0.469	6.151	260.79	41.02	-3.49	37.81	2.17
74.89	20.80										
48	SAGEEND	-186.87	-53.48	0.51	0.552	4.662	272.79	40.88	-3.56	38.02	2.09
74.86	20.79										
49	SAGEEND	-198.84	-54.29	0.39	0.633	3.170	284.79	40.78	-3.62	38.13	2.07
74.76	20.77										
50	SAGEEND	-210.83	-54.80	0.25	0.709	1.680	296.79	40.71	-3.65	37.46	1.62
74.01	20.56										
51	SEABED	-222.83	-55.01	0.10	0.693	0.339	308.79	40.69	-3.66	25.36	-6.73
64.42	17.89										
52	SEABED	-234.83	-55.03	0.01	0.141	0.001	320.79	40.68	-3.66	1.24	-11.62
52.37	14.55										
53	SEABED	-246.83	-55.02	0.00	0.000	-0.001	332.79	40.68	-3.66	-0.06	-0.39
42.95	11.93										
54	SEABED	-258.83	-55.02	0.00	0.000	0.000	344.79	40.68	-3.66	0.00	0.03
42.66	11.85										
55	SEABED	-270.83	-55.02	0.00	0.000	0.000	356.79	40.68	-3.66	0.00	0.00
42.64	11.84										
56	SEABED	-282.83	-55.02	0.00	0.000	0.000	368.79	40.68	-3.66	0.00	0.00
42.64	11.84										

57	SEABED	-294.83	-55.02	0.00	0.000	0.000	380.79	40.68	-3.66	0.00	0.00
42.64	11.84										
58	SEABED	-306.83	-55.02	0.00	0.000	0.000	392.79	40.68	-3.66	0.00	0.00
42.64	11.84										

OFFPIPE - OFFSHORE PIPELINE ANALYSIS SYSTEM - VERSION 2.05 AC DATE - 5/ 6/2020 TIME - 21: 6:22
 PAGE 106
 PROJECT - TUGAS AKHIR JOB NO. - ANALISIS
 DINAMIS
 USER ID - IDA BAGUS HUNDHARA SAKYANARY LICENSED TO: RICKY TAWKAL CASE
 4

NODE TOTAL NO.	PIPE SECTION	X COORD	Y COORD	Z COORD	HORIZ ANGLE	VERT ANGLE	PIPE LENGTH	TENSILE STRESS	HOOP STRESS	ENDING STRESSES	
										VERT	HORIZ
	YIELD	(M)	(M)	(M)	(DEG)	(DEG)	(M)	(MPA)	(MPA)	(MPA)	(MPA)
1	TENSIONR	77.79	6.21	0.00	0.000	0.314	0.00	48.71	0.00	0.00	0.00
48.71	13.53										
3	LAYARGE	71.49	6.16	0.00	0.000	0.956	6.30	48.69	0.00	-106.59	0.00
139.28	38.69										
5	LAYARGE	65.38	5.99	0.00	0.000	2.221	12.42	48.67	0.00	-76.69	0.00
113.85	31.63										
7	LAYARGE	59.91	5.72	0.00	0.000	3.296	17.89	48.63	0.00	-87.56	0.00
123.04	34.18										
9	LAYARGE	53.32	5.28	0.00	0.000	4.484	24.49	48.56	0.00	-84.15	0.00
120.08	33.35										
11	LAYARGE	47.32	4.74	0.00	0.000	5.780	30.51	48.47	0.00	-103.45	0.00
136.39	37.89										
13	LAYARGE	38.22	3.69	0.00	0.000	7.420	39.68	48.30	0.00	-124.46	0.00
154.09	42.80										
15	LAYARGE	29.27	2.39	0.00	0.000	9.064	48.72	48.10	0.00	-102.41	0.02
135.15	37.54										
17	LAYARGE	23.13	1.34	0.00	0.000	10.379	54.95	47.93	0.00	-85.50	-0.08
120.59	33.50										
19	LAYARGE	17.18	0.19	0.00	0.002	11.410	61.01	47.75	0.00	-68.24	0.37
105.70	29.36										

21	LAVARGE	10.63	-1.22	0.00	-0.021	13.189	67.72	47.55	-0.08	-159.47	-5.39
183.20	50.89										
24	STINGER	-4.61	-5.09	0.00	0.022	15.162	83.44	47.05	-0.34	-137.29	-5.29
163.99	45.55										
26	STINGER	-11.02	-6.94	0.00	-0.005	16.600	90.11	46.83	-0.46	-48.69	-0.53
88.44	24.57										
28	STINGER	-17.40	-8.88	0.00	0.003	17.442	96.77	46.58	-0.59	-67.36	-1.16
104.13	28.92										
30	STINGER	-23.74	-10.94	0.00	-0.009	18.446	103.44	46.32	-0.73	-67.42	-3.09
104.02	28.89										
32	STINGER	-30.05	-13.10	0.00	0.082	19.261	110.11	46.04	-0.87	-45.73	10.82
86.05	23.90										
34	STINGER	-36.32	-15.36	0.00	-0.382	20.845	116.77	45.72	-1.02	-159.02	-64.19
191.80	53.28										
36	SAGEEND	-47.46	-19.81	0.17	-1.012	21.649	128.77	45.18	-1.32	22.80	0.54
64.84	18.01										
37	SAGEEND	-58.66	-24.12	0.36	-0.879	20.460	140.77	44.62	-1.61	33.11	3.99
73.50	20.42										
38	SAGEEND	-69.94	-28.19	0.52	-0.709	19.141	152.77	44.10	-1.88	34.19	4.05
74.10	20.58										
39	SAGEEND	-81.33	-31.99	0.64	-0.544	17.791	164.77	43.61	-2.13	34.70	3.88
74.23	20.62										
40	SAGEEND	-92.79	-35.52	0.73	-0.388	16.420	176.77	43.15	-2.37	35.21	3.73
74.36	20.65										
41	SAGEEND	-104.34	-38.77	0.80	-0.238	15.028	188.77	42.73	-2.59	35.70	3.57
74.51	20.70										
42	SAGEEND	-115.97	-41.74	0.83	-0.098	13.619	200.77	42.35	-2.78	36.20	3.38
74.64	20.73										
43	SAGEEND	-127.67	-44.42	0.84	0.033	12.194	212.77	42.00	-2.96	36.64	3.16
74.74	20.76										
44	SAGEEND	-139.43	-46.81	0.82	0.154	10.752	224.77	41.70	-3.12	37.00	2.91
74.80	20.78										
45	SAGEEND	-151.24	-48.90	0.77	0.264	9.297	236.77	41.43	-3.26	37.30	2.66
74.84	20.79										
46	SAGEEND	-163.11	-50.69	0.71	0.364	7.829	248.77	41.20	-3.38	37.56	2.42
74.87	20.80										
47	SAGEEND	-175.02	-52.17	0.62	0.453	6.351	260.77	41.01	-3.48	37.79	2.21
74.86	20.80										
48	SAGEEND	-186.96	-53.34	0.52	0.536	4.865	272.77	40.86	-3.55	37.99	2.12
74.83	20.79										
49	SAGEEND	-198.93	-54.20	0.40	0.618	3.374	284.77	40.75	-3.61	38.12	2.12
74.76	20.77										
50	SAGEEND	-210.91	-54.75	0.26	0.695	1.883	296.77	40.68	-3.65	37.71	1.79
74.25	20.63										
51	SAGEEND	-222.91	-54.99	0.11	0.706	0.485	308.77	40.65	-3.66	29.80	-4.71
67.68	18.80										
52	SEABED	-234.91	-55.03	0.01	0.190	0.006	320.77	40.65	-3.66	2.16	-14.15
54.39	15.11										
53	SEABED	-246.91	-55.02	0.00	0.000	-0.001	332.77	40.65	-3.66	-0.08	-0.67
43.10	11.97										
54	SEABED	-258.91	-55.02	0.00	0.000	0.000	344.77	40.65	-3.66	0.00	0.04
42.62	11.84										
55	SEABED	-270.91	-55.02	0.00	0.000	0.000	356.77	40.65	-3.66	0.00	0.00
42.60	11.83										
56	SEABED	-282.91	-55.02	0.00	0.000	0.000	368.77	40.65	-3.66	0.00	0.00
42.60	11.83										
57	SEABED	-294.91	-55.02	0.00	0.000	0.000	380.77	40.65	-3.66	0.00	0.00
42.60	11.83										
58	SEABED	-306.91	-55.02	0.00	0.000	0.000	392.77	40.65	-3.66	0.00	0.00
42.60	11.83										
59	SEABED	-318.91	-55.02	0.00	0.000	0.000	404.77	40.65	-3.66	0.00	0.00
42.60	11.83										

OFFPIPE - OFFSHORE PIPELINE ANALYSIS SYSTEM - VERSION 2.05 AC DATE - 5/ 6/2020 TIME - 21: 6:22
PAGE 106
PROJECT - TUGAS AKHIR JOB NO. - ANALISIS
DINAMIS
USER ID - IDA BAGUS FUNDHARA SAKYANARY LICENSED TO: RICKY TAMEKAL CASE
5

NODE TOTAL NO. STRESS (MPA)	PIPE BECONF SECTION YIELD (PCT)	X COORD (M)	Y COORD (M)	Z COORD (M)	HORIZ ANGLE (DEG)	VERT ANGLE (DEG)	PIPE LENGIH (M)	TENSILE STRESS (MPA)	HOOP STRESS (MPA)	BENDING STRESSES VERT (MPA)	HORIZ (MPA)
1 56.86	TENSIONR 15.80	77.79	6.21	0.00	0.000	0.318	0.00	56.86	0.00	0.00	0.00
3 149.52	LAYBARGE 41.53	71.49	6.16	0.00	0.000	0.958	6.30	56.84	0.00	-109.04	0.00
5 123.83	LAYBARGE 34.40	65.38	5.99	0.00	0.000	2.220	12.42	56.82	0.00	-78.84	0.00
7 133.15	LAYBARGE 36.98	59.91	5.72	0.00	0.000	3.299	17.89	56.78	0.00	-89.84	0.00
9 130.23	LAYBARGE 36.17	53.32	5.27	0.00	0.000	4.483	24.49	56.71	0.00	-86.50	0.00
11 147.77	LAYBARGE 41.05	47.32	4.74	0.00	0.000	5.786	30.51	56.62	0.00	-107.23	0.00
13 166.83	LAYBARGE 46.34	38.22	3.69	0.00	0.000	7.420	39.68	56.45	0.00	-129.86	0.00
15 146.56	LAYBARGE 40.71	29.27	2.39	0.00	0.000	9.059	48.72	56.25	0.00	-106.25	0.01
17 130.62	LAYBARGE 36.28	23.13	1.33	0.00	0.000	10.380	54.95	56.08	0.00	-87.70	-0.06
19 115.27	LAYBARGE 32.02	17.18	0.19	0.00	0.001	11.410	61.01	55.91	0.00	-69.90	0.29
21 199.30	LAYBARGE 55.36	10.63	-1.22	0.00	-0.020	13.214	67.72	55.69	-0.08	-168.84	-5.17
24 236.35	STINGER 65.65	-4.64	-5.13	0.00	0.011	15.779	83.47	55.18	-0.34	-212.89	-6.47
26 145.88	STINGER 40.52	-11.00	-7.10	0.00	0.035	18.271	90.14	54.96	-0.47	-106.52	6.73
28 162.32	STINGER 45.09	-17.30	-9.29	0.00	-0.180	20.015	96.81	54.67	-0.62	-121.94	-35.29
30 107.83	STINGER 29.95	-23.54	-11.65	0.05	-0.754	21.285	103.47	54.38	-0.78	-51.73	-35.18
32 68.65	STINGER 19.07	-29.74	-14.09	0.15	-1.046	21.408	110.14	54.07	-0.94	17.07	-1.82
34 76.66	STINGER 21.29	-35.96	-16.50	0.27	-1.013	20.905	116.81	53.76	-1.10	26.46	2.98
36 78.04	SAGEBND 21.68	-47.21	-20.68	0.45	-0.867	19.813	128.81	53.22	-1.38	28.43	3.64

37	SAGEEND	-58.53	-24.63	0.61	-0.717	18.692	140.81	52.71	-1.64	28.87	3.57
78.09	21.69										
38	SAGEEND	-69.94	-28.37	0.74	-0.572	17.554	152.81	52.22	-1.89	29.23	3.45
78.09	21.69										
39	SAGEEND	-81.41	-31.87	0.84	-0.434	16.401	164.81	51.77	-2.13	29.58	3.30
78.10	21.69										
40	SAGEEND	-92.96	-35.14	0.91	-0.302	15.233	176.81	51.35	-2.34	29.90	3.17
78.10	21.69										
41	SAGEEND	-104.57	-38.17	0.96	-0.176	14.054	188.81	50.96	-2.55	30.24	3.05
78.10	21.69										
42	SAGEEND	-116.24	-40.97	0.98	-0.056	12.862	200.81	50.60	-2.73	30.58	2.90
78.09	21.69										
43	SAGEEND	-127.97	-43.51	0.98	0.056	11.658	212.81	50.27	-2.90	30.88	2.73
78.08	21.69										
44	SAGEEND	-139.74	-45.81	0.96	0.161	10.444	224.81	49.97	-3.05	31.13	2.53
78.06	21.68										
45	SAGEEND	-151.57	-47.86	0.92	0.258	9.220	236.81	49.71	-3.19	31.33	2.34
78.04	21.68										
46	SAGEEND	-163.43	-49.66	0.85	0.347	7.988	248.81	49.48	-3.31	31.52	2.14
78.01	21.67										
47	SAGEEND	-175.33	-51.20	0.77	0.427	6.749	260.81	49.28	-3.41	31.68	1.95
77.97	21.66										
48	SAGEEND	-187.26	-52.48	0.68	0.500	5.502	272.81	49.11	-3.50	31.84	1.82
77.91	21.64										
49	SAGEEND	-199.22	-53.50	0.57	0.569	4.249	284.81	48.98	-3.56	31.99	1.77
77.85	21.63										
50	SAGEEND	-211.19	-54.26	0.44	0.638	2.993	296.81	48.89	-3.61	32.08	1.77
77.78	21.60										
51	SAGEEND	-223.18	-54.75	0.30	0.704	1.737	308.81	48.83	-3.65	31.91	1.60
77.49	21.53										
52	SAGEEND	-235.18	-54.99	0.15	0.735	0.530	320.81	48.80	-3.66	27.34	-2.08
73.65	20.46										
53	SEAFED	-247.18	-55.02	0.03	0.327	0.018	332.81	48.79	-3.66	3.01	-14.35
62.94	17.48										
54	SEAFED	-259.18	-55.02	0.00	0.013	-0.001	344.81	48.79	-3.66	-0.02	-1.97
52.32	14.53										
55	SEAFED	-271.18	-55.02	0.00	0.000	0.000	356.81	48.79	-3.66	-0.01	0.01
50.73	14.09										
56	SEAFED	-283.18	-55.02	0.00	0.000	0.000	368.81	48.79	-3.66	0.00	0.00
50.73	14.09										
57	SEAFED	-295.18	-55.02	0.00	0.000	0.000	380.81	48.79	-3.66	0.00	0.00
50.73	14.09										
58	SEAFED	-307.18	-55.02	0.00	0.000	0.000	392.81	48.79	-3.66	0.00	0.00
50.73	14.09										
59	SEAFED	-319.18	-55.02	0.00	0.000	0.000	404.81	48.79	-3.66	0.00	0.00
50.73	14.09										

NODE TOTAL NO. STRESS (MPA)	PIPE PERCENT SECTION YIELD (PCT)	X COORD (M)	Y COORD (M)	Z COORD (M)	HORIZ ANGLE (DEG)	VERT ANGLE (DEG)	PIPE LENGIH (M)	TENSILE STRESS (MPA)	HOOP STRESS (MPA)	BENDING VERT (MPA)	SIRESES HORIZ (MPA)
1	TENSIONR	77.79	6.21	0.00	0.000	0.318	0.00	56.82	0.00	0.00	0.00
56.82	15.78										
3	LAYARGE	71.49	6.16	0.00	0.000	0.958	6.30	56.80	0.00	-109.01	0.00
149.44	41.51										
5	LAYARGE	65.38	5.99	0.00	0.000	2.220	12.42	56.78	0.00	-78.82	0.00
123.77	34.38										
7	LAYARGE	59.91	5.73	0.00	0.000	3.299	17.89	56.74	0.00	-89.82	0.00
133.07	36.97										
9	LAYARGE	53.32	5.28	0.00	0.000	4.483	24.49	56.67	0.00	-86.47	0.00
130.16	36.16										
11	LAYARGE	47.32	4.74	0.00	0.000	5.786	30.51	56.58	0.00	-107.19	0.00
147.68	41.02										
13	LAYARGE	38.22	3.69	0.00	0.000	7.420	39.68	56.41	0.00	-129.81	0.00
166.73	46.31										
15	LAYARGE	29.27	2.39	0.00	0.000	9.059	48.72	56.21	0.00	-106.22	0.01
146.49	40.69										
17	LAYARGE	23.13	1.33	0.00	0.000	10.380	54.95	56.04	0.00	-87.65	-0.07
130.54	36.26										
19	LAYARGE	17.18	0.18	0.00	0.001	11.411	61.01	55.87	0.00	-70.06	0.32
115.37	32.05										
21	LAYARGE	10.63	-1.23	0.00	-0.020	13.210	67.72	55.66	-0.08	-168.09	-5.29
198.63	55.18										
24	STINGER	-4.62	-5.11	0.00	0.022	15.356	83.45	55.16	-0.34	-167.56	-5.10
197.80	54.95										
26	STINGER	-11.02	-6.99	0.00	-0.008	17.152	90.12	54.94	-0.47	-67.92	-1.09
112.91	31.36										
28	STINGER	-17.37	-9.02	0.00	0.015	18.324	96.78	54.67	-0.60	-91.52	1.43
132.76	36.88										
30	STINGER	-23.67	-11.18	0.00	-0.066	19.565	103.45	54.40	-0.75	-76.19	-14.63
120.38	33.44										
32	STINGER	-29.93	-13.48	0.03	-0.568	20.622	110.12	54.10	-0.90	-72.01	-47.90
127.90	35.53										
34	STINGER	-36.16	-15.86	0.12	-0.991	20.937	116.79	53.80	-1.06	14.03	-3.88
66.25	18.40										
36	SAGEEND	-47.40	-20.06	0.31	-0.915	19.976	128.79	53.26	-1.34	27.75	3.33
77.45	21.51										
37	SAGEEND	-58.71	-24.05	0.48	-0.769	18.861	140.79	52.74	-1.60	28.81	3.57
78.03	21.68										
38	SAGEEND	-70.11	-27.82	0.62	-0.624	17.724	152.79	52.26	-1.85	29.19	3.47
78.05	21.68										
39	SAGEEND	-81.57	-31.35	0.73	-0.485	16.577	164.79	51.80	-2.09	29.55	3.33
78.03	21.68										
40	SAGEEND	-93.11	-34.66	0.81	-0.352	15.412	176.79	51.38	-2.31	29.89	3.20
78.03	21.67										
41	SAGEEND	-104.71	-37.73	0.87	-0.225	14.234	188.79	50.98	-2.52	30.20	3.07
78.05	21.68										
42	SAGEEND	-116.37	-40.56	0.90	-0.104	13.044	200.79	50.62	-2.70	30.55	2.93
78.06	21.68										
43	SAGEEND	-128.09	-43.15	0.91	0.010	11.840	212.79	50.29	-2.88	30.87	2.76
78.06	21.68										

44	SAGEBND	-139.86	-45.48	0.90	0.115	10.627	224.79	49.99	-3.03	31.14	2.57
78.05	21.68										
45	SAGEBND	-151.67	-47.57	0.87	0.213	9.404	236.79	49.72	-3.17	31.35	2.38
78.02	21.67										
46	SAGEBND	-163.53	-49.40	0.81	0.303	8.173	248.79	49.48	-3.29	31.51	2.18
77.97	21.66										
47	SAGEBND	-175.43	-50.98	0.74	0.385	6.934	260.79	49.28	-3.40	31.65	1.99
77.92	21.64										
48	SAGEBND	-187.35	-52.30	0.65	0.459	5.688	272.79	49.11	-3.49	31.81	1.85
77.86	21.63										
49	SAGEBND	-199.31	-53.36	0.55	0.528	4.439	284.79	48.98	-3.56	31.97	1.79
77.81	21.61										
50	SAGEBND	-211.28	-54.16	0.43	0.597	3.185	296.79	48.87	-3.61	32.08	1.79
77.75	21.60										
51	SAGEBND	-223.27	-54.69	0.30	0.663	1.929	308.79	48.81	-3.64	32.01	1.66
77.55	21.54										
52	SAGEBND	-235.26	-54.97	0.16	0.703	0.700	320.79	48.77	-3.66	29.09	-1.22
75.06	20.85										
53	SEALED	-247.26	-55.02	0.03	0.377	0.034	332.79	48.77	-3.66	4.74	-13.96
62.91	17.48										
54	SEALED	-259.26	-55.02	0.00	0.019	-0.001	344.79	48.77	-3.66	0.04	-2.59
52.80	14.67										
55	SEALED	-271.26	-55.02	0.00	-0.001	0.000	356.79	48.77	-3.66	-0.01	-0.02
50.71	14.09										
56	SEALED	-283.26	-55.02	0.00	0.000	0.000	368.79	48.77	-3.66	0.00	0.01
50.70	14.08										
57	SEALED	-295.26	-55.02	0.00	0.000	0.000	380.79	48.77	-3.66	0.00	0.00
50.70	14.08										
58	SEALED	-307.26	-55.02	0.00	0.000	0.000	392.79	48.77	-3.66	0.00	0.00
50.70	14.08										
59	SEALED	-319.26	-55.02	0.00	0.000	0.000	404.79	48.77	-3.66	0.00	0.00
50.70	14.08										
60	SEALED	-331.26	-55.02	0.00	0.000	0.000	416.79	48.77	-3.66	0.00	0.00
50.70	14.08										

OFFPIPE - OFFSHORE PIPELINE ANALYSIS SYSTEM - VERSION 2.05 AC DATE - 5/ 6/2020 TIME - 21: 6:22
PAGE 106
PROJECT - TUGAS AKHIR JOB NO. - ANALISIS
DINPMIS
USER ID - IDA BAGUS FUNDHARA SAKYANARY LICENSED TO: RICKY TAMEKAL CASE
7

NODE	PIPE	X	Y	Z	HORIZ	VERT	PIPE	TENSILE	HOOP	BENDING STRESSES
TOTAL	BEFORE									

NO. STRESS (MPA)	SECTION YIELD (PCT)	COORD (M)	COORD (M)	COORD (M)	ANGLE (DEG)	ANGLE (DEG)	LENGTH (M)	STRESS (MPA)	STRESS (MPA)	VERT (MPA)	HORIZ (MPA)
1	TENSIONR	77.79	6.21	0.00	0.000	0.318	0.00	56.90	0.00	0.00	0.00
56.90	15.81										
3	LAYBARGE	71.49	6.16	0.00	0.000	0.958	6.30	56.88	0.00	-109.03	0.00
149.55	41.54										
5	LAYBARGE	65.37	5.98	0.00	0.000	2.220	12.42	56.86	0.00	-78.84	0.00
123.87	34.41										
7	LAYBARGE	59.91	5.72	0.00	0.000	3.299	17.89	56.81	0.00	-89.84	0.00
133.18	36.99										
9	LAYBARGE	53.32	5.27	0.00	0.000	4.483	24.49	56.74	0.00	-86.49	0.00
130.26	36.18										
11	LAYBARGE	47.32	4.74	0.00	0.000	5.786	30.51	56.66	0.00	-107.23	0.00
147.80	41.06										
13	LAYBARGE	38.21	3.69	0.00	0.000	7.420	39.68	56.49	0.00	-129.85	0.00
166.86	46.35										
15	LAYBARGE	29.27	2.39	0.00	0.000	9.059	48.72	56.29	0.00	-106.26	0.01
146.61	40.72										
17	LAYBARGE	23.13	1.33	0.00	0.000	10.380	54.95	56.12	0.00	-87.65	-0.07
130.61	36.28										
19	LAYBARGE	17.18	0.18	0.00	0.001	11.410	61.01	55.94	0.00	-70.13	0.31
115.53	32.09										
21	LAYBARGE	10.63	-1.23	0.00	-0.020	13.209	67.72	55.73	-0.08	-167.86	-5.28
198.51	55.14										
24	STINGER	-4.61	-5.09	0.00	0.021	15.143	83.44	55.24	-0.34	-144.82	-5.25
178.52	49.59										
26	STINGER	-11.02	-6.94	0.00	-0.004	16.602	90.11	55.02	-0.46	-50.01	-0.41
97.76	27.15										
28	STINGER	-17.40	-8.88	0.00	-0.001	17.445	96.77	54.77	-0.59	-69.77	-1.96
114.39	31.77										
30	STINGER	-23.74	-10.94	0.00	0.011	18.439	103.44	54.50	-0.73	-68.26	1.15
112.87	31.35										
32	STINGER	-30.05	-13.10	0.00	-0.052	19.314	110.11	54.23	-0.87	-55.26	-12.21
102.32	28.42										
34	STINGER	-36.32	-15.35	0.02	-0.539	20.196	116.77	53.93	-1.02	-71.65	-49.09
127.92	35.53										
36	SAGEEND	-47.57	-19.53	0.20	-0.940	20.075	128.77	53.40	-1.30	23.71	1.21
73.81	20.50										
37	SAGEEND	-58.88	-23.55	0.37	-0.817	19.004	140.77	52.88	-1.57	28.58	3.48
77.81	21.61										
38	SAGEEND	-70.26	-27.34	0.52	-0.672	17.874	152.77	52.39	-1.82	29.16	3.48
78.03	21.68										
39	SAGEEND	-81.71	-30.91	0.64	-0.532	16.727	164.77	51.93	-2.06	29.50	3.35
78.06	21.68										
40	SAGEEND	-93.24	-34.25	0.73	-0.398	15.565	176.77	51.50	-2.28	29.84	3.21
78.08	21.69										
41	SAGEEND	-104.83	-37.35	0.80	-0.271	14.388	188.77	51.10	-2.49	30.15	3.09
78.09	21.69										
42	SAGEEND	-116.49	-40.21	0.84	-0.149	13.199	200.77	50.73	-2.68	30.50	2.94
78.13	21.70										
43	SAGEEND	-128.20	-42.83	0.86	-0.034	11.997	212.77	50.39	-2.86	30.82	2.78
78.14	21.71										
44	SAGEEND	-139.96	-45.20	0.86	0.073	10.785	224.77	50.09	-3.01	31.11	2.59
78.14	21.70										
45	SAGEEND	-151.77	-47.32	0.83	0.172	9.564	236.77	49.82	-3.16	31.35	2.40
78.11	21.70										
46	SAGEEND	-163.62	-49.19	0.79	0.263	8.334	248.77	49.58	-3.28	31.53	2.20
78.07	21.69										
47	SAGEEND	-175.51	-50.80	0.73	0.345	7.096	260.77	49.37	-3.39	31.67	2.00
78.00	21.67										
48	SAGEEND	-187.44	-52.15	0.65	0.421	5.851	272.77	49.20	-3.48	31.79	1.85
77.92	21.65										
49	SAGEEND	-199.39	-53.24	0.55	0.490	4.598	284.77	49.06	-3.55	31.94	1.78
77.87	21.63										

50	SAGEND	-211.36	-54.07	0.44	0.559	3.343	296.77	48.95	-3.60	32.08	1.77
77.80	21.61										
51	SAGEND	-223.34	-54.64	0.32	0.627	2.087	308.77	48.88	-3.64	32.06	1.72
77.62	21.56										
52	SAGEND	-235.34	-54.95	0.18	0.681	0.852	320.77	48.84	-3.66	29.96	0.54
75.80	21.06										
53	SEABED	-247.34	-55.02	0.05	0.476	0.057	332.77	48.83	-3.66	6.93	-12.98
62.70	17.42										
54	SEABED	-259.34	-55.03	0.00	0.036	-0.001	344.77	48.83	-3.66	0.12	-4.16
54.10	15.03										
55	SEABED	-271.34	-55.02	0.00	0.000	0.000	356.77	48.83	-3.66	-0.01	-0.08
50.82	14.12										
56	SEABED	-283.34	-55.02	0.00	0.000	0.000	368.77	48.83	-3.66	0.00	0.01
50.77	14.10										
57	SEABED	-295.34	-55.02	0.00	0.000	0.000	380.77	48.83	-3.66	0.00	0.00
50.76	14.10										
58	SEABED	-307.34	-55.02	0.00	0.000	0.000	392.77	48.83	-3.66	0.00	0.00
50.76	14.10										
59	SEABED	-319.34	-55.02	0.00	0.000	0.000	404.77	48.83	-3.66	0.00	0.00
50.76	14.10										
60	SEABED	-331.34	-55.02	0.00	0.000	0.000	416.77	48.83	-3.66	0.00	0.00
50.76	14.10										

OFFPIPE - OFFSHORE PIPELINE ANALYSIS SYSTEM - VERSION 2.05 AC DATE - 5/ 6/2020 TIME - 21: 6:22
PAGE 106
PROJECT - TUGAS AKHIR JOB NO. - ANALISIS
DINPMIS
USER ID - IDA BAGUS PUNDHARA SARYANARY LICENSED TO: RICKY TAMEKAL CASE
8

NODE TOTAL NO. STRESS (MPA)	PIPE BERONT SECTION YIELD (ECT)	X	Y	Z	HORIZ	VERT	PIPE	TENSILE	HOOP	BENDING STRESSES	
		COORD (M)	COORD (M)	COORD (M)	ANGLE (DEG)	ANGLE (DEG)	LENGIH (M)	STRESS (MPA)	STRESS (MPA)	VERT (MPA)	HORIZ (MPA)
1	TENSIONR	77.79	6.21	0.00	0.000	0.321	0.00	65.09	0.00	0.00	0.00
65.09	18.08										
3	LAYARGE	71.49	6.16	0.00	0.000	0.960	6.30	65.07	0.00	-111.49	0.00
159.84	44.40										
5	LAYARGE	65.37	5.98	0.00	0.000	2.217	12.42	65.05	0.00	-81.00	0.00
133.90	37.20										

7	LAYARGE	59.91	5.72	0.00	0.000	3.300	17.89	65.01	0.00	-92.14	0.00
143.33	39.81										
9	LAYARGE	53.32	5.27	0.00	0.000	4.481	24.49	64.94	0.00	-88.87	0.00
140.48	39.02										
11	LAYARGE	47.32	4.74	0.00	0.000	5.792	30.51	64.85	0.00	-111.04	0.00
159.23	44.23										
13	LAYARGE	38.22	3.69	0.00	0.000	7.419	39.68	64.68	0.00	-135.27	0.00
179.66	49.91										
15	LAYARGE	29.27	2.39	0.00	0.000	9.054	48.72	64.48	0.00	-110.11	0.01
158.07	43.91										
17	LAYARGE	23.13	1.33	0.00	0.000	10.380	54.95	64.32	0.00	-89.92	-0.06
140.74	39.10										
19	LAYARGE	17.18	0.19	0.00	0.001	11.408	61.01	64.14	0.00	-71.59	0.26
124.96	34.71										
21	LAYARGE	10.63	-1.22	0.00	-0.019	13.238	67.72	63.92	-0.08	-178.40	-5.14
215.66	59.91										
24	STINGER	-4.64	-5.13	0.00	0.015	15.754	83.47	63.40	-0.34	-224.14	-5.91
254.16	70.60										
26	STINGER	-11.01	-7.10	0.00	0.017	18.269	90.14	63.19	-0.47	-109.36	4.76
156.44	43.45										
28	STINGER	-17.31	-9.28	0.01	-0.455	19.841	96.81	62.90	-0.62	-107.19	-63.30
168.92	46.92										
30	STINGER	-23.56	-11.60	0.10	-1.005	20.475	103.47	62.62	-0.77	8.14	-5.10
70.75	19.65										
32	STINGER	-29.81	-13.91	0.21	-1.007	20.092	110.14	62.32	-0.93	22.36	2.31
81.64	22.68										
34	STINGER	-36.08	-16.18	0.32	-0.940	19.576	116.81	62.03	-1.08	24.36	3.17
83.18	23.11										
36	SAGEEND	-47.42	-20.10	0.49	-0.806	18.610	128.81	61.52	-1.34	24.93	3.21
83.32	23.14										
37	SAGEEND	-58.82	-23.84	0.64	-0.677	17.630	140.81	61.04	-1.59	25.21	3.12
83.25	23.12										
38	SAGEEND	-70.29	-27.37	0.76	-0.551	16.638	152.81	60.59	-1.83	25.45	3.02
83.17	23.10										
39	SAGEEND	-81.82	-30.71	0.86	-0.430	15.635	164.81	60.15	-2.05	25.66	2.90
83.09	23.08										
40	SAGEEND	-93.40	-33.84	0.94	-0.314	14.623	176.81	59.75	-2.26	25.91	2.79
83.02	23.06										
41	SAGEEND	-105.04	-36.76	0.99	-0.203	13.600	188.81	59.37	-2.45	26.18	2.70
82.96	23.04										
42	SAGEEND	-116.72	-39.48	1.02	-0.097	12.568	200.81	59.02	-2.63	26.42	2.58
82.89	23.02										
43	SAGEEND	-128.46	-41.98	1.03	0.004	11.528	212.81	58.70	-2.80	26.65	2.46
82.83	23.01										
44	SAGEEND	-140.24	-44.27	1.02	0.099	10.481	224.81	58.40	-2.95	26.85	2.31
82.76	22.99										
45	SAGEEND	-152.06	-46.35	0.99	0.187	9.425	236.81	58.14	-3.09	27.02	2.15
82.69	22.97										
46	SAGEEND	-163.91	-48.20	0.94	0.269	8.365	248.81	57.90	-3.21	27.15	2.00
82.63	22.95										
47	SAGEEND	-175.80	-49.84	0.88	0.344	7.299	260.81	57.69	-3.32	27.26	1.84
82.55	22.93										
48	SAGEEND	-187.72	-51.25	0.80	0.413	6.227	272.81	57.51	-3.42	27.37	1.69
82.49	22.91										
49	SAGEEND	-199.66	-52.44	0.71	0.476	5.150	284.81	57.36	-3.49	27.50	1.58
82.42	22.89										
50	SAGEEND	-211.62	-53.40	0.60	0.536	4.070	296.81	57.23	-3.56	27.60	1.54
82.34	22.87										
51	SAGEEND	-223.60	-54.14	0.48	0.595	2.988	308.81	57.14	-3.61	27.69	1.55
82.26	22.85										
52	SAGEEND	-235.58	-54.66	0.35	0.653	1.902	320.81	57.07	-3.64	27.69	1.51
82.12	22.81										
53	SAGEEND	-247.58	-54.94	0.21	0.703	0.829	332.81	57.04	-3.66	26.32	0.71
80.92	22.48										
54	SEABED	-259.58	-55.02	0.07	0.559	0.075	344.81	57.03	-3.66	7.68	-10.94
69.61	19.34										
55	SEABED	-271.58	-55.02	0.00	0.079	0.001	356.81	57.03	-3.66	0.31	-7.02
64.55	17.93										
56	SEABED	-283.58	-55.02	0.00	0.001	0.000	368.81	57.03	-3.66	-0.01	-0.35
59.22	16.45										

57	SEABED	-295.58	-55.02	0.00	0.000	0.000	380.81	57.03	-3.66	0.00	0.00
58.95	16.37										
58	SEABED	-307.58	-55.02	0.00	0.000	0.000	392.81	57.03	-3.66	0.00	0.00
58.95	16.37										
59	SEABED	-319.58	-55.02	0.00	0.000	0.000	404.81	57.03	-3.66	0.00	0.00
58.95	16.37										
60	SEABED	-331.58	-55.02	0.00	0.000	0.000	416.81	57.03	-3.66	0.00	0.00
58.95	16.37										

OFFPIPE - OFFSHORE PIPELINE ANALYSIS SYSTEM - VERSION 2.05 AC DATE - 5/ 6/2020 TIME - 21: 6:22
PAGE 106
PROJECT - TUGAS AKHIR JOB NO. - ANALISIS
DINPMIS
USER ID - IDA BAGUS PUNDHARA SARZANARY LICENSED TO: RICKY TAMEKAL CASE
9

NODE TOTAL NO.	PIPE SECTION YIELD	X	Y	Z	HORIZ	VERT	PIPE	TENSILE	HOOP	BENDING STRESSES	
		COORD	COORD	COORD	ANGLE	ANGLE	LENGIH	STRESS	STRESS	VERT	HORIZ
(MPA)	(PCT)	(M)	(M)	(M)	(DEG)	(DEG)	(M)	(MPA)	(MPA)	(MPA)	(MPA)
1	TENSIONR	77.79	6.21	0.00	0.000	0.322	0.00	65.08	0.00	0.00	0.00
65.08	18.08										
3	LAYBARGE	71.49	6.16	0.00	0.000	0.960	6.30	65.06	0.00	-111.49	0.00
159.83	44.40										
5	LAYBARGE	65.37	5.99	0.00	0.000	2.218	12.42	65.04	0.00	-81.00	0.00
133.89	37.19										
7	LAYBARGE	59.91	5.72	0.00	0.000	3.301	17.89	65.00	0.00	-92.14	0.00
143.32	39.81										
9	LAYBARGE	53.32	5.27	0.00	0.000	4.482	24.49	64.93	0.00	-88.87	0.00
140.47	39.02										
11	LAYBARGE	47.32	4.74	0.00	0.000	5.792	30.51	64.84	0.00	-111.03	0.00
159.22	44.23										
13	LAYBARGE	38.21	3.69	0.00	0.000	7.420	39.68	64.67	0.00	-135.27	0.00
179.64	49.90										
15	LAYBARGE	29.27	2.39	0.00	0.000	9.055	48.72	64.47	0.00	-110.12	0.01
158.07	43.91										
17	LAYBARGE	23.13	1.33	0.00	0.000	10.380	54.95	64.31	0.00	-89.84	-0.06
140.67	39.08										
19	LAYBARGE	17.18	0.18	0.00	0.001	11.410	61.01	64.13	0.00	-71.93	0.27
125.23	34.79										

21	LAVARGE	10.63	-1.23	0.00	-0.019	13.231	67.72	63.91	-0.08	-176.83	-5.19
214.32	59.53										
24	STINGER	-4.62	-5.11	0.00	0.019	15.334	83.45	63.41	-0.34	-175.97	-5.20
213.20	59.22										
26	STINGER	-11.02	-6.99	0.00	-0.002	17.161	90.12	63.20	-0.47	-71.41	-0.40
124.01	34.45										
28	STINGER	-17.37	-9.02	0.00	-0.008	18.291	96.78	62.93	-0.60	-88.55	-4.21
138.38	38.44										
30	STINGER	-23.67	-11.18	0.01	-0.422	19.472	103.45	62.65	-0.75	-77.83	-48.89
140.77	39.10										
32	STINGER	-29.94	-13.44	0.09	-0.905	19.961	110.12	62.37	-0.90	-4.30	-12.41
73.48	20.41										
34	STINGER	-36.22	-15.70	0.20	-0.963	19.660	116.79	62.08	-1.05	21.52	1.66
80.38	22.33										
36	SAGEEND	-47.55	-19.65	0.38	-0.845	18.723	128.79	61.57	-1.31	24.78	3.17
83.11	23.08										
37	SAGEEND	-58.94	-23.41	0.53	-0.716	17.741	140.79	61.08	-1.56	25.21	3.16
83.17	23.10										
38	SAGEEND	-70.40	-26.96	0.66	-0.590	16.750	152.79	60.63	-1.80	25.45	3.06
83.11	23.09										
39	SAGEEND	-81.92	-30.32	0.77	-0.468	15.749	164.79	60.19	-2.02	25.70	2.94
83.06	23.07										
40	SAGEEND	-93.50	-33.48	0.85	-0.352	14.739	176.79	59.78	-2.23	25.93	2.82
83.00	23.06										
41	SAGEEND	-105.13	-36.43	0.91	-0.241	13.721	188.79	59.40	-2.43	26.15	2.72
82.95	23.04										
42	SAGEEND	-116.81	-39.17	0.95	-0.134	12.691	200.79	59.05	-2.61	26.41	2.61
82.90	23.03										
43	SAGEEND	-128.54	-41.70	0.97	-0.032	11.651	212.79	58.72	-2.78	26.64	2.49
82.84	23.01										
44	SAGEEND	-140.32	-44.01	0.97	0.064	10.603	224.79	58.42	-2.93	26.85	2.35
82.78	23.00										
45	SAGEEND	-152.13	-46.11	0.94	0.152	9.550	236.79	58.15	-3.07	27.03	2.19
82.72	22.98										
46	SAGEEND	-163.98	-47.99	0.90	0.235	8.490	248.79	57.91	-3.20	27.17	2.03
82.66	22.96										
47	SAGEEND	-175.87	-49.65	0.85	0.311	7.426	260.79	57.70	-3.31	27.29	1.87
82.59	22.94										
48	SAGEEND	-187.78	-51.10	0.77	0.381	6.355	272.79	57.51	-3.41	27.37	1.72
82.52	22.92										
49	SAGEEND	-199.72	-52.31	0.69	0.445	5.280	284.79	57.36	-3.49	27.48	1.59
82.44	22.90										
50	SAGEEND	-211.68	-53.30	0.59	0.505	4.200	296.79	57.23	-3.55	27.58	1.55
82.36	22.88										
51	SAGEEND	-223.65	-54.07	0.48	0.564	3.115	308.79	57.13	-3.60	27.67	1.55
82.28	22.85										
52	SAGEEND	-235.64	-54.61	0.35	0.623	2.029	320.79	57.06	-3.64	27.70	1.53
82.16	22.82										
53	SAGEEND	-247.63	-54.92	0.22	0.675	0.955	332.79	57.02	-3.66	26.68	0.94
81.20	22.56										
54	SEABED	-259.63	-55.02	0.08	0.587	0.113	344.79	57.01	-3.66	10.48	-9.58
70.08	19.47										
55	SEABED	-271.63	-55.02	0.01	0.105	0.002	356.79	57.01	-3.66	0.51	-8.53
65.93	18.31										
56	SEABED	-283.63	-55.02	0.00	0.002	0.000	368.79	57.01	-3.66	-0.01	-0.50
59.31	16.47										
57	SEABED	-295.63	-55.02	0.00	0.000	0.000	380.79	57.01	-3.66	0.00	0.00
58.93	16.37										
58	SEABED	-307.63	-55.02	0.00	0.000	0.000	392.79	57.01	-3.66	0.00	0.00
58.93	16.37										
59	SEABED	-319.63	-55.02	0.00	0.000	0.000	404.79	57.01	-3.66	0.00	0.00
58.93	16.37										
60	SEABED	-331.63	-55.02	0.00	0.000	0.000	416.79	57.01	-3.66	0.00	0.00
58.93	16.37										

GRAFIK ANALISA DINAMIS HEADING 45°

OFFPIPE 3 - V 3.02EX - Date: 6/20/20 - User: IDA BAGUS PUNDHARA S - Job: ANALISIS DINAMIS
Project: TUGAS AKHIR CLUSTER I PHE WMO 6.625in

MAXIMUM DYNAMIC STRESS

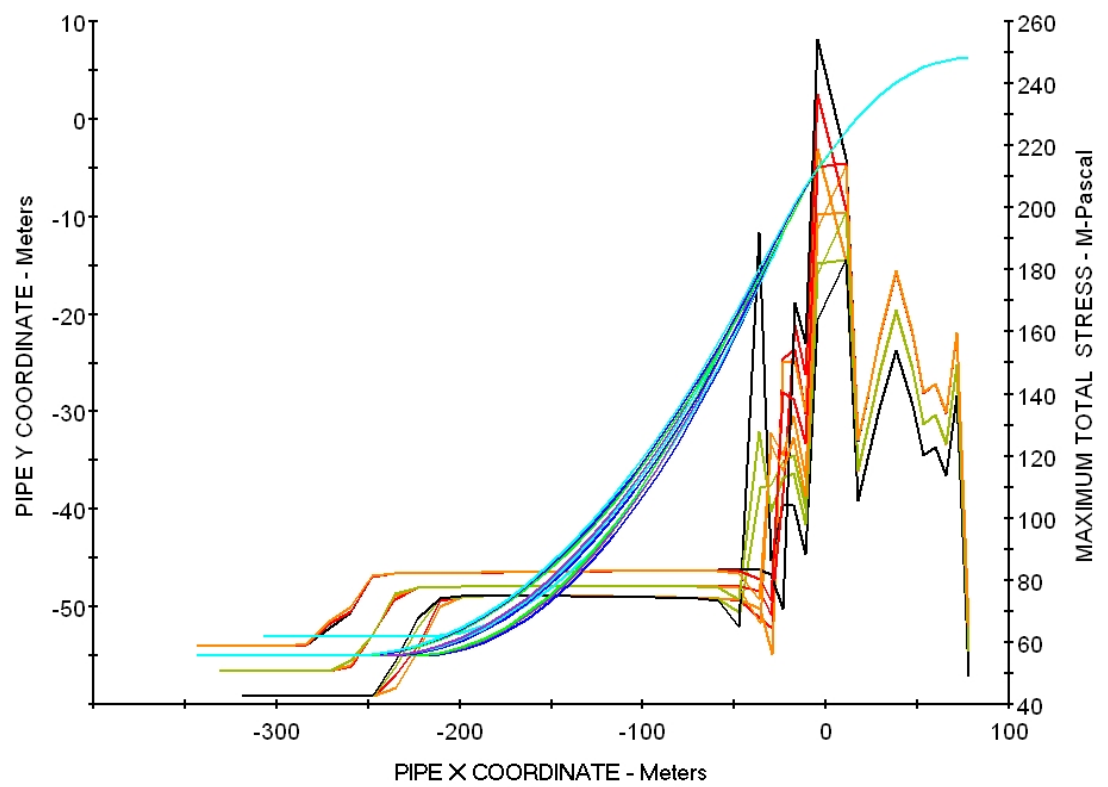

OUTPUT REGANGAN ANALISA DINAMIS HEADING 45°

SOLUTION SUMMARY									
NODE NO.	PIPE SECTION	X COORD (M)	Y COORD (M)	Z COORD (M)	SUPPORT VERT (KN)	REACT HORIZ (KN)	TOTAL MOMENT (KN-M)	TOTAL STRAIN (PCT)	PCT ALL (%)
1	TENSIONR	77.8	6.2	0.0	-2.5	0.0	0.0	0.028	0.
3	LAYBARGE	71.5	6.2	0.0	23.5	0.0	46.9	0.044	0.
5	LAYBARGE	65.4	6.0	0.0	10.0	0.0	33.8	0.028	0.
7	LAYBARGE	59.9	5.7	0.0	14.5	0.0	38.2	0.064	0.
9	LAYBARGE	53.3	5.3	0.0	13.0	0.0	36.8	0.032	0.
11	LAYBARGE	47.3	4.7	0.0	17.2	0.0	41.9	0.088	0.
13	LAYBARGE	38.2	3.7	0.0	21.5	0.0	47.4	0.045	0.
15	LAYBARGE	29.3	2.4	0.0	16.9	0.0	41.6	0.027	0.
17	LAYBARGE	23.1	1.3	0.0	13.6	-0.1	37.4	0.062	0.
19	LAYBARGE	17.2	0.2	0.0	8.3	0.0	32.6	0.056	0.
21	LAYBARGE	10.6	-1.2	0.0	20.8	-1.4	54.3	0.043	0.
24	STINGER	-4.6	-5.1	0.0	26.8	-1.2	74.0	0.113	0.
26	STINGER	-11.0	-7.1	0.0	8.8	-1.4	47.9	0.055	0.
28	STINGER	-17.3	-9.3	0.0	16.0	3.5	55.7	0.064	0.
30	STINGER	-23.5	-11.7	0.0	15.7	-7.3	52.3	0.078	0.
32	STINGER	-29.7	-14.2	0.1	7.7	-4.5	26.0	0.049	0.
34	STINGER	-35.8	-16.9	0.2	0.0	0.0	7.8	0.022	0.
46	SAGEBND	-162.8	-51.0	0.7	0.0	0.0	23.2	0.043	0.
50	SEABED	-210.7	-53.0	0.0	7.9	-3.8	9.0	0.026	0.

SOLUTION SUMMARY									
NODE NO.	PIPE SECTION	X COORD (M)	Y COORD (M)	Z COORD (M)	SUPPORT VERT (KN)	REACT HORIZ (KN)	TOTAL MOMENT (KN-M)	TOTAL STRAIN (PCT)	PCT ALL (%)
1	TENSIONR	77.8	6.2	0.0	-2.5	0.0	0.0	0.028	0.
3	LAYBARGE	71.5	6.2	0.0	23.5	0.0	46.9	0.054	0.
5	LAYBARGE	65.4	6.0	0.0	10.0	0.0	33.8	0.038	0.
7	LAYBARGE	59.9	5.7	0.0	14.5	0.0	38.2	0.054	0.
9	LAYBARGE	53.3	5.3	0.0	13.0	0.0	36.8	0.072	0.
11	LAYBARGE	47.3	4.7	0.0	17.2	0.0	41.9	0.048	0.
13	LAYBARGE	38.2	3.7	0.0	21.5	0.0	47.4	0.035	0.
15	LAYBARGE	29.3	2.4	0.0	16.9	0.0	41.6	0.067	0.
17	LAYBARGE	23.1	1.3	0.0	13.8	0.0	37.5	0.062	0.
19	LAYBARGE	17.2	0.2	0.0	7.9	0.0	32.1	0.056	0.
21	LAYBARGE	10.6	-1.2	0.0	22.0	-1.4	56.2	0.082	0.
24	STINGER	-4.6	-5.1	0.0	21.7	-1.4	56.1	0.081	0.
26	STINGER	-11.0	-7.0	0.0	6.1	-0.4	31.5	0.053	0.
28	STINGER	-17.4	-9.0	0.0	11.4	-0.9	37.2	0.064	0.
30	STINGER	-23.7	-11.2	0.0	11.5	-0.5	37.3	0.032	0.
32	STINGER	-29.9	-13.5	0.0	8.5	1.7	32.3	0.055	0.
34	STINGER	-36.1	-15.9	0.0	16.6	-9.7	45.4	0.071	0.
47	SAGEBND	-174.9	-51.8	0.5	0.0	0.0	23.3	0.043	0.
50	SEABED	-210.9	-53.0	0.1	6.9	-3.8	9.4	0.036	0.

SOLUTION SUMMARY									
NODE NO.	PIPE SECTION	X COORD (M)	Y COORD (M)	Z COORD (M)	SUPPORT VERT (KN)	REACT HORIZ (KN)	TOTAL MOMENT (KN-M)	TOTAL STRAIN (PCT)	PCT ALL (%)
1	TENSIONR	77.8	6.2	0.0	-2.5	0.0	0.0	0.038	0.
3	LAYBARGE	71.5	6.2	0.0	23.5	0.0	46.9	0.054	0.
5	LAYBARGE	65.4	6.0	0.0	10.0	0.0	33.8	0.068	0.
7	LAYBARGE	59.9	5.7	0.0	14.5	0.0	38.2	0.064	0.
9	LAYBARGE	53.3	5.3	0.0	13.0	0.0	36.8	0.042	0.
11	LAYBARGE	47.3	4.7	0.0	17.2	0.0	41.9	0.088	0.
13	LAYBARGE	38.2	3.7	0.0	21.5	0.0	47.4	0.065	0.
15	LAYBARGE	29.3	2.4	0.0	16.9	0.0	41.5	0.047	0.
17	LAYBARGE	23.1	1.3	0.0	13.8	0.0	37.6	0.072	0.
19	LAYBARGE	17.2	0.2	0.0	7.7	0.0	31.9	0.066	0.
21	LAYBARGE	10.6	-1.2	0.0	22.6	-1.4	57.2	0.046	0.

24	STINGER	-4.6	-5.1	0.0	19.2	-1.5	47.3	0.074	0.
26	STINGER	-11.0	-6.9	0.0	4.5	-0.1	23.0	0.045	0.
28	STINGER	-17.4	-8.9	0.0	10.4	-1.9	29.2	0.062	0.
30	STINGER	-23.7	-10.9	0.0	9.1	2.1	27.2	0.069	0.
32	STINGER	-30.0	-13.1	0.0	0.8	0.5	22.0	0.033	0.
34	STINGER	-36.3	-15.4	0.0	32.0	-10.6	79.7	0.102	0.
47	SAGEBND	-175.0	-51.6	0.6	0.0	0.0	23.3	0.063	0.
50	SEABED	-210.9	-53.0	0.1	6.0	-3.4	10.2	0.047	0.

SOLUTION SUMMARY

NODE NO.	PILE SECTION	X	Y	Z	SUPPORT	REACT	TOTAL	TOTAL	PCT
		COORD (M)	COORD (M)	COORD (M)	VERT (KN)	HORIZ (KN)	MOMENT (KN-M)	STRAIN (PCT)	ALL (%)
1	TENSIONR	77.8	6.2	0.0	-2.4	0.0	0.0	0.034	0.
3	LAYBARGE	71.5	6.2	0.0	25.7	0.0	48.1	0.031	0.
5	LAYBARGE	65.4	6.0	0.0	11.9	0.0	34.8	0.065	0.
7	LAYBARGE	59.9	5.7	0.0	16.6	0.0	39.3	0.071	0.
9	LAYBARGE	53.3	5.3	0.0	15.0	0.0	37.8	0.059	0.
11	LAYBARGE	47.3	4.7	0.0	19.8	0.0	43.7	0.046	0.
13	LAYBARGE	38.2	3.7	0.0	24.7	0.0	49.9	0.073	0.
15	LAYBARGE	29.3	2.4	0.0	19.5	0.0	43.3	0.085	0.
17	LAYBARGE	23.1	1.3	0.0	15.7	0.0	38.5	0.069	0.
19	LAYBARGE	17.2	0.2	0.0	9.6	-0.1	32.9	0.063	0.
21	LAYBARGE	10.6	-1.2	0.0	25.3	-1.3	59.5	0.055	0.
24	STINGER	-4.6	-5.1	0.0	32.4	-2.5	79.8	0.107	0.
26	STINGER	-11.0	-7.1	0.0	12.5	5.3	50.6	0.064	0.
28	STINGER	-17.3	-9.3	0.0	21.2	-12.3	57.8	0.042	0.
30	STINGER	-23.5	-11.6	0.1	3.3	-1.9	13.5	0.069	0.
32	STINGER	-29.8	-14.0	0.2	0.0	0.0	8.8	0.033	0.
34	STINGER	-36.0	-16.4	0.3	0.0	0.0	13.3	0.068	0.
48	SAGEBND	-187.6	-51.0	0.7	0.0	0.0	16.8	0.081	0.
52	SEABED	-235.5	-53.0	0.1	4.8	-2.8	8.7	0.051	0.

SOLUTION SUMMARY

NODE NO.	PILE SECTION	X	Y	Z	SUPPORT	REACT	TOTAL	TOTAL	PCT
		COORD (M)	COORD (M)	COORD (M)	VERT (KN)	HORIZ (KN)	MOMENT (KN-M)	STRAIN (PCT)	ALL (%)
1	TENSIONR	77.8	6.2	0.0	-2.4	0.0	0.0	0.054	0.
3	LAYBARGE	71.5	6.2	0.0	25.7	0.0	48.1	0.031	0.
5	LAYBARGE	65.4	6.0	0.0	11.9	0.0	34.8	0.065	0.
7	LAYBARGE	59.9	5.7	0.0	16.6	0.0	39.3	0.051	0.
9	LAYBARGE	53.3	5.3	0.0	15.0	0.0	37.8	0.049	0.
11	LAYBARGE	47.3	4.7	0.0	19.8	0.0	43.7	0.066	0.
13	LAYBARGE	38.2	3.7	0.0	24.7	0.0	49.9	0.083	0.
15	LAYBARGE	29.3	2.4	0.0	19.5	0.0	43.3	0.055	0.
17	LAYBARGE	23.1	1.3	0.0	15.8	0.0	38.5	0.080	0.
19	LAYBARGE	17.2	0.2	0.0	9.3	0.0	32.6	0.062	0.
21	LAYBARGE	10.6	-1.2	0.0	26.4	-1.4	60.9	0.092	0.
24	STINGER	-4.6	-5.1	0.0	26.1	-1.3	60.8	0.036	0.
26	STINGER	-11.0	-7.0	0.0	7.4	-1.2	31.8	0.051	0.
28	STINGER	-17.4	-9.0	0.0	15.4	2.9	40.3	0.061	0.
30	STINGER	-23.7	-11.2	0.0	12.0	-6.9	35.2	0.065	0.
32	STINGER	-29.9	-13.5	0.1	9.1	-5.3	22.8	0.030	0.
34	STINGER	-36.2	-15.8	0.2	0.0	0.0	7.1	0.051	0.
48	SAGEBND	-187.7	-50.8	0.7	0.0	0.0	16.8	0.061	0.
52	SEABED	-235.6	-53.0	0.1	3.7	-2.2	10.0	0.053	0.

SOLUTION SUMMARY

NODE NO.	PILE SECTION	X	Y	Z	SUPPORT	REACT	TOTAL	TOTAL	PCT
		COORD (M)	COORD (M)	COORD (M)	VERT (KN)	HORIZ (KN)	MOMENT (KN-M)	STRAIN (PCT)	ALL (%)
1	TENSIONR	77.8	6.2	0.0	-2.4	0.0	0.0	0.024	0.
3	LAYBARGE	71.5	6.2	0.0	25.7	0.0	48.1	0.051	0.
5	LAYBARGE	65.4	6.0	0.0	11.9	0.0	34.8	0.065	0.
7	LAYBARGE	59.9	5.7	0.0	16.6	0.0	39.3	0.071	0.
9	LAYBARGE	53.3	5.3	0.0	15.0	0.0	37.8	0.079	0.
11	LAYBARGE	47.3	4.7	0.0	19.8	0.0	43.7	0.056	0.
13	LAYBARGE	38.2	3.7	0.0	24.7	0.0	49.9	0.043	0.
15	LAYBARGE	29.3	2.4	0.0	19.4	0.0	43.2	0.075	0.
17	LAYBARGE	23.1	1.3	0.0	15.9	0.0	38.6	0.050	0.

19	LAYBARGE	17.2	0.2	0.0	9.1	0.0	32.4	0.042	0.
21	LAYBARGE	10.6	-1.2	0.0	26.9	-1.4	61.6	0.094	0.
24	STINGER	-4.6	-5.1	0.0	22.9	-1.4	51.3	0.055	0.
26	STINGER	-11.0	-6.9	0.0	5.5	-0.4	23.4	0.061	0.
28	STINGER	-17.4	-8.9	0.0	12.0	-1.2	30.1	0.079	0.
30	STINGER	-23.7	-10.9	0.0	11.3	1.7	29.1	0.058	0.
32	STINGER	-30.0	-13.1	0.0	9.3	-5.4	26.3	0.044	0.
34	STINGER	-36.3	-15.3	0.1	9.4	-5.5	21.8	0.059	0.
48	SAGEBND	-187.8	-50.7	0.7	0.0	0.0	16.8	0.061	0.
52	SEABED	-235.7	-53.0	0.1	2.8	-1.7	11.4	0.065	0.

SOLUTION SUMMARY

NODE NO.	FILE SECTION	X	Y	Z	SUPPORT	REACT	TOTAL	TOTAL	PCT
		COORD (M)	COORD (M)	COORD (M)	VERT (KN)	HORIZ (KN)	MOMENT (KN-M)	STRAIN (PCT)	ALL (%)
1	TENSIONR	77.8	6.2	0.0	-2.5	0.0	0.0	0.018	0.
3	LAYBARGE	71.5	6.2	0.0	23.5	0.0	46.9	0.075	0.
5	LAYBARGE	65.4	6.0	0.0	10.0	0.0	33.8	0.054	0.
7	LAYBARGE	59.9	5.7	0.0	14.5	0.0	38.2	0.054	0.
9	LAYBARGE	53.3	5.3	0.0	13.0	0.0	36.8	0.062	0.
11	LAYBARGE	47.3	4.7	0.0	17.2	0.0	41.9	0.067	0.
13	LAYBARGE	38.2	3.7	0.0	21.5	0.0	47.4	0.056	0.
15	LAYBARGE	29.3	2.4	0.0	16.9	0.0	41.6	0.065	0.
17	LAYBARGE	23.1	1.3	0.0	13.6	-0.1	37.4	0.064	0.
19	LAYBARGE	17.2	0.2	0.0	8.3	0.0	32.6	0.036	0.
21	LAYBARGE	10.6	-1.2	0.0	20.8	-1.4	54.3	0.043	0.
24	STINGER	-4.6	-5.1	0.0	26.8	-1.3	74.0	0.114	0.
26	STINGER	-11.0	-7.1	0.0	8.8	-0.8	48.0	0.045	0.
28	STINGER	-17.3	-9.3	0.0	15.7	1.0	55.3	0.043	0.
30	STINGER	-23.5	-11.7	0.0	14.1	-1.6	50.9	0.076	0.
32	STINGER	-29.7	-14.3	0.0	14.2	-8.3	43.7	0.064	0.
34	STINGER	-35.8	-17.0	0.1	0.0	0.0	5.0	0.043	0.
47	SAGEBND	-174.1	-54.5	0.6	0.0	0.0	23.5	0.053	0.
50	SEABED	-210.0	-56.0	0.1	4.6	-2.8	12.0	0.049	0.

SOLUTION SUMMARY

NODE NO.	FILE SECTION	X	Y	Z	SUPPORT	REACT	TOTAL	TOTAL	PCT
		COORD (M)	COORD (M)	COORD (M)	VERT (KN)	HORIZ (KN)	MOMENT (KN-M)	STRAIN (PCT)	ALL (%)
1	TENSIONR	77.8	6.2	0.0	-2.5	0.0	0.0	0.018	0.
3	LAYBARGE	71.5	6.2	0.0	23.5	0.0	46.9	0.064	0.
5	LAYBARGE	65.4	6.0	0.0	10.0	0.0	33.8	0.058	0.
7	LAYBARGE	59.9	5.7	0.0	14.5	0.0	38.2	0.084	0.
9	LAYBARGE	53.3	5.3	0.0	13.0	0.0	36.8	0.002	0.
11	LAYBARGE	47.3	4.7	0.0	17.2	0.0	41.9	0.088	0.
13	LAYBARGE	38.2	3.7	0.0	21.5	0.0	47.4	0.075	0.
15	LAYBARGE	29.3	2.4	0.0	16.9	0.0	41.6	0.047	0.
17	LAYBARGE	23.1	1.3	0.0	13.8	0.0	37.5	0.062	0.
19	LAYBARGE	17.2	0.2	0.0	7.9	0.0	32.1	0.056	0.
21	LAYBARGE	10.6	-1.2	0.0	22.0	-1.4	56.2	0.075	0.
24	STINGER	-4.6	-5.1	0.0	21.7	-1.4	56.1	0.065	0.
26	STINGER	-11.0	-7.0	0.0	6.0	-0.4	31.4	0.065	0.
28	STINGER	-17.4	-9.0	0.0	11.8	-0.9	37.5	0.042	0.
30	STINGER	-23.7	-11.2	0.0	10.6	-0.9	36.0	0.060	0.
32	STINGER	-29.9	-13.5	0.0	7.0	4.1	33.6	0.054	0.
34	STINGER	-36.1	-15.9	0.0	23.2	-12.1	62.7	0.134	0.
47	SAGEBND	-174.3	-54.2	0.6	0.0	0.0	23.4	0.043	0.
50	SEABED	-210.2	-56.0	0.1	2.8	-1.7	15.6	0.034	0.

SOLUTION SUMMARY

NODE NO.	FILE SECTION	X	Y	Z	SUPPORT	REACT	TOTAL	TOTAL	PCT
		COORD (M)	COORD (M)	COORD (M)	VERT (KN)	HORIZ (KN)	MOMENT (KN-M)	STRAIN (PCT)	ALL (%)
1	TENSIONR	77.8	6.2	0.0	-2.5	0.0	0.0	0.018	0.
3	LAYBARGE	71.5	6.2	0.0	23.5	0.0	46.9	0.054	0.
5	LAYBARGE	65.4	6.0	0.0	10.0	0.0	33.8	0.038	0.
7	LAYBARGE	59.9	5.7	0.0	14.5	0.0	38.2	0.054	0.
9	LAYBARGE	53.3	5.3	0.0	13.0	0.0	36.8	0.042	0.
11	LAYBARGE	47.3	4.7	0.0	17.2	0.0	41.9	0.078	0.
13	LAYBARGE	38.2	3.7	0.0	21.5	0.0	47.4	0.055	0.

15	LAYBARGE	29.3	2.4	0.0	16.9	0.0	41.5	0.037	0.
17	LAYBARGE	23.1	1.3	0.0	13.8	0.0	37.6	0.042	0.
19	LAYBARGE	17.2	0.2	0.0	7.7	0.0	31.9	0.076	0.
21	LAYBARGE	10.6	-1.2	0.0	22.6	-1.4	57.2	0.066	0.
24	STINGER	-4.6	-5.1	0.0	19.3	-1.5	47.3	0.054	0.
26	STINGER	-11.0	-6.9	0.0	4.3	-0.1	22.8	0.044	0.
28	STINGER	-17.4	-8.9	0.0	11.2	-2.0	30.2	0.063	0.
30	STINGER	-23.7	-10.9	0.0	7.1	2.5	23.5	0.055	0.
32	STINGER	-30.1	-13.1	0.0	0.0	0.0	24.5	0.046	0.
34	STINGER	-36.3	-15.4	0.0	38.8	-10.4	97.3	0.091	0.
47	SAGEBND	-174.3	-54.0	0.6	0.0	0.0	23.4	0.046	0.
51	SEABED	-222.3	-56.0	0.0	8.1	-3.5	8.1	0.023	0.

OUTPUT ANALISA DINAMIS HEADING 90°

OFFPIPE - OFFSHORE PIPELINE ANALYSIS SYSTEM - VERSION 2.05 AC DATE - 5/ 6/2020 TIME - 21: 6:22
PAGE 106
PROJECT - TUGAS AKHIR JOB NO. - ANALISIS
DINAMIS
USER ID - IDA FAGUS FUNDHARA SAKYANARY LICENSED TO: RICKY TAMEKAL CASE
1

NODE TOTAL NO.	PIPE PERCENT SECTION YIELD	X	Y	Z	HORIZ	VERT	PIPE	TENSILE	HOOP	BENDING STRESSES	
		COORD (M)	COORD (M)	COORD (M)	ANGLE (DEG)	ANGLE (DEG)	LENGIH (M)	STRESS (MPA)	STRESS (MPA)	VERT (MPA)	HORIZ (MPA)
1	TENSIONR	77.79	6.21	0.00	0.000	0.314	0.00	48.73	0.00	0.00	0.00
48.73	13.54										
3	LAYBARGE	71.49	6.16	0.00	0.000	0.956	6.30	48.71	0.00	-106.61	0.00
139.33	38.70										
5	LAYBARGE	65.38	5.98	0.00	0.000	2.221	12.42	48.69	0.00	-76.71	0.00
113.89	31.64										
7	LAYBARGE	59.91	5.72	0.00	0.000	3.296	17.89	48.64	0.00	-87.57	0.00
123.08	34.19										
9	LAYBARGE	53.32	5.27	0.00	0.000	4.484	24.49	48.57	0.00	-84.16	0.00
120.11	33.36										
11	LAYBARGE	47.32	4.74	0.00	0.000	5.780	30.51	48.49	0.00	-103.48	0.00
136.44	37.90										
13	LAYBARGE	38.21	3.69	0.00	0.000	7.420	39.68	48.32	0.00	-124.51	0.00
154.14	42.82										
15	LAYBARGE	29.27	2.39	0.00	0.000	9.063	48.72	48.12	0.00	-102.45	0.02
135.19	37.55										
17	LAYBARGE	23.13	1.33	0.00	0.000	10.379	54.95	47.95	0.00	-85.47	-0.08
120.60	33.50										
19	LAYBARGE	17.18	0.19	0.00	0.002	11.411	61.01	47.77	0.00	-68.32	0.34
105.83	29.40										
21	LAYBARGE	10.63	-1.22	0.00	-0.022	13.187	67.72	47.56	-0.08	-159.16	-5.58
182.96	50.82										
24	STINGER	-4.64	-5.13	0.00	0.026	15.808	83.47	47.05	-0.34	-201.92	-4.92
218.89	60.80										
26	STINGER	-11.01	-7.10	0.00	-0.021	18.257	90.14	46.82	-0.47	-101.59	-3.15
133.45	37.07										
28	STINGER	-17.30	-9.29	0.00	0.071	20.059	96.81	46.54	-0.62	-125.95	10.98
154.22	42.84										
30	STINGER	-23.53	-11.68	0.00	-0.319	21.937	103.47	46.23	-0.78	-110.14	-57.55
151.43	42.06										

32	STINGER	-29.68	-14.24	0.08	-0.968	22.821	110.14	45.92	-0.95	-12.71	-17.87
64.69	17.97										
34	STINGER	-35.83	-16.81	0.19	-1.093	22.538	116.81	45.58	-1.12	25.71	1.10
67.59	18.77										
36	SAGEBND	-46.96	-21.30	0.39	-0.951	21.327	128.81	45.00	-1.42	32.89	4.14
73.56	20.43										
37	SAGEBND	-58.19	-25.54	0.56	-0.776	20.021	140.81	44.46	-1.70	33.86	4.17
74.04	20.57										
38	SAGEBND	-69.51	-29.51	0.70	-0.606	18.685	152.81	43.94	-1.97	34.40	4.02
74.19	20.61										
39	SAGEBND	-80.92	-33.22	0.80	-0.445	17.328	164.81	43.47	-2.22	34.87	3.84
74.34	20.65										
40	SAGEBND	-92.42	-36.66	0.88	-0.291	15.951	176.81	43.02	-2.44	35.38	3.69
74.47	20.69										
41	SAGEBND	-103.99	-39.81	0.92	-0.144	14.553	188.81	42.61	-2.65	35.88	3.51
74.59	20.72										
42	SAGEBND	-115.64	-42.69	0.93	-0.007	13.137	200.81	42.24	-2.85	36.38	3.31
74.69	20.75										
43	SAGEBND	-127.36	-45.27	0.92	0.121	11.706	212.81	41.91	-3.02	36.80	3.08
74.77	20.77										
44	SAGEBND	-139.14	-47.55	0.89	0.238	10.259	224.81	41.62	-3.17	37.13	2.83
74.84	20.79										
45	SAGEBND	-150.98	-49.54	0.83	0.344	8.800	236.81	41.36	-3.30	37.40	2.57
74.89	20.80										
46	SAGEBND	-162.86	-51.22	0.74	0.441	7.330	248.81	41.15	-3.41	37.63	2.33
74.91	20.81										
47	SAGEBND	-174.78	-52.60	0.64	0.528	5.849	260.81	40.97	-3.51	37.87	2.17
74.90	20.81										
48	SAGEBND	-186.73	-53.67	0.52	0.611	4.357	272.81	40.83	-3.58	38.06	2.11
74.86	20.79										
49	SAGEBND	-198.70	-54.43	0.39	0.692	2.863	284.81	40.74	-3.63	38.11	2.07
74.72	20.76										
50	SAGEBND	-210.69	-54.87	0.24	0.762	1.378	296.81	40.68	-3.66	36.81	1.25
73.42	20.39										
51	SEALED	-222.69	-55.02	0.08	0.662	0.174	308.81	40.66	-3.66	16.87	-11.56
59.17	16.44										
52	SEALED	-234.69	-55.03	0.00	0.082	-0.002	320.81	40.66	-3.66	0.43	-8.37
49.49	13.75										
53	SEALED	-246.69	-55.02	0.00	-0.001	0.000	332.81	40.66	-3.66	-0.04	-0.16
42.73	11.87										
54	SEALED	-258.69	-55.02	0.00	0.000	0.000	344.81	40.66	-3.66	0.00	0.02
42.63	11.84										
55	SEALED	-270.69	-55.02	0.00	0.000	0.000	356.81	40.66	-3.66	0.00	0.00
42.62	11.84										
56	SEALED	-282.69	-55.02	0.00	0.000	0.000	368.81	40.66	-3.66	0.00	0.00
42.61	11.84										
57	SEALED	-294.69	-55.02	0.00	0.000	0.000	380.81	40.66	-3.66	0.00	0.00
42.62	11.84										
58	SEALED	-306.69	-55.02	0.00	0.000	0.000	392.81	40.66	-3.66	0.00	0.00
42.61	11.84										

OFFPIPE - OFFSHORE PIPELINE ANALYSIS SYSTEM - VERSION 2.05 AC DATE - 5/ 6/2020 TIME - 21: 6:22
PAGE 106
PROJECT - TUGAS AKHIR JOB NO. - ANALISIS
DINPMIS
USER ID - IDA BAGUS PUNDHARA SAKYANARY LICENSED TO: RICKY TAJEKAL CASE
2

NODE TOTAL NO. STRESS (MPA)	PIPE PERCENT SECTION YIELD (PCT)	X COORD (M)	Y COORD (M)	Z COORD (M)	HORIZ ANGLE (DEG)	VERT ANGLE (DEG)	PIPE LENGTH (M)	TENSILE STRESS (MPA)	HOOP STRESS (MPA)	BENDING VERT STRESSES (MPA)	HORIZ STRESSES (MPA)
1	TENSIONR	77.79	6.21	0.00	0.000	0.316	0.00	48.79	0.00	0.00	0.00
48.79	13.55										
3	LAYFARGE	71.49	6.16	0.00	0.000	0.957	6.30	48.77	0.00	-106.63	0.00
139.40	38.72										
5	LAYFARGE	65.37	5.98	0.00	0.000	2.222	12.42	48.74	0.00	-76.73	0.00
113.96	31.66										
7	LAYFARGE	59.91	5.72	0.00	0.000	3.297	17.89	48.70	0.00	-87.59	0.00
123.16	34.21										
9	LAYFARGE	53.32	5.27	0.00	0.000	4.486	24.49	48.63	0.00	-84.19	0.00
120.19	33.39										
11	LAYFARGE	47.32	4.74	0.00	0.000	5.781	30.51	48.54	0.00	-103.51	0.00
136.53	37.92										
13	LAYFARGE	38.22	3.69	0.00	0.000	7.421	39.68	48.37	0.00	-124.56	0.00
154.25	42.85										
15	LAYFARGE	29.27	2.39	0.00	0.000	9.065	48.72	48.17	0.00	-102.48	0.02
135.28	37.58										
17	LAYFARGE	23.13	1.33	0.00	0.000	10.381	54.95	48.01	0.00	-85.51	-0.08
120.69	33.52										
19	LAYFARGE	17.18	0.18	0.00	0.002	11.412	61.01	47.83	0.00	-68.33	0.33
105.86	29.41										
21	LAYFARGE	10.63	-1.23	0.00	-0.021	13.187	67.72	47.62	-0.08	-159.35	-5.58
183.18	50.88										
24	STINGER	-4.64	-5.13	0.00	0.023	15.810	83.47	47.10	-0.34	-201.98	-5.37
219.01	60.84										
26	STINGER	-11.00	-7.10	0.00	-0.009	18.263	90.14	46.88	-0.47	-102.46	-1.49
134.21	37.28										
28	STINGER	-17.30	-9.29	0.00	0.020	20.039	96.81	46.59	-0.62	-122.23	3.43
150.76	41.88										
30	STINGER	-23.53	-11.67	0.01	-0.489	21.821	103.47	46.28	-0.78	-105.67	-61.48
150.36	41.77										
32	STINGER	-29.70	-14.21	0.11	-1.084	22.475	110.14	45.97	-0.95	10.18	-6.62
56.22	15.62										
34	STINGER	-35.86	-16.73	0.23	-1.097	21.993	116.81	45.64	-1.12	28.90	2.65
70.56	19.60										
36	SAGEEND	-47.04	-21.10	0.43	-0.936	20.740	128.81	45.08	-1.41	33.13	4.25
73.90	20.53										
37	SAGEEND	-58.31	-25.23	0.59	-0.760	19.422	140.81	44.54	-1.68	33.88	4.22
74.21	20.61										
38	SAGEEND	-69.67	-29.09	0.73	-0.590	18.084	152.81	44.05	-1.94	34.41	4.08
74.36	20.66										
39	SAGEEND	-81.12	-32.68	0.83	-0.427	16.725	164.81	43.58	-2.18	34.93	3.92
74.49	20.69										
40	SAGEEND	-92.65	-35.99	0.90	-0.272	15.344	176.81	43.15	-2.40	35.42	3.79
74.62	20.73										
41	SAGEEND	-104.26	-39.02	0.94	-0.124	13.946	188.81	42.76	-2.60	35.93	3.66
74.73	20.76										

42	SAGEEND	-115.94	-41.77	0.95	0.015	12.530	200.81	42.41	-2.79	36.36	3.49
74.84	20.79										
43	SAGEEND	-127.69	-44.23	0.93	0.146	11.098	212.81	42.09	-2.95	36.72	3.31
74.92	20.81										
44	SAGEEND	-139.49	-46.39	0.89	0.268	9.651	224.81	41.81	-3.09	37.03	3.12
74.98	20.83										
45	SAGEEND	-151.34	-48.25	0.82	0.379	8.193	236.81	41.57	-3.22	37.29	2.96
75.01	20.84										
46	SAGEEND	-163.24	-49.81	0.73	0.483	6.724	248.81	41.37	-3.32	37.54	2.79
75.01	20.84										
47	SAGEEND	-175.18	-51.06	0.62	0.578	5.246	260.81	41.21	-3.40	37.78	2.68
74.97	20.83										
48	SAGEEND	-187.14	-52.00	0.49	0.667	3.761	272.81	41.09	-3.46	37.94	2.60
74.90	20.81										
49	SAGEEND	-199.12	-52.64	0.34	0.748	2.273	284.81	41.01	-3.51	37.86	2.40
74.62	20.73										
50	SAGEEND	-211.11	-52.96	0.18	0.798	0.825	296.81	40.97	-3.53	34.16	-1.75
71.40	19.83										
51	SEAFED	-223.11	-53.02	0.04	0.450	0.032	308.81	40.97	-3.53	5.41	-16.60
57.07	15.85										
52	SEAFED	-235.11	-53.03	0.00	0.018	-0.002	320.81	40.96	-3.53	-0.08	-3.37
45.39	12.61										
53	SEAFED	-247.11	-53.02	0.00	-0.001	0.000	332.81	40.96	-3.53	-0.01	0.05
42.87	11.91										
54	SEAFED	-259.11	-53.02	0.00	0.000	0.000	344.81	40.96	-3.53	0.00	0.01
42.84	11.90										
55	SEAFED	-271.11	-53.02	0.00	0.000	0.000	356.81	40.96	-3.53	0.00	0.00
42.84	11.90										
56	SEAFED	-283.11	-53.02	0.00	0.000	0.000	368.81	40.97	-3.53	0.00	0.00
42.84	11.90										
57	SEAFED	-295.11	-53.02	0.00	0.000	0.000	380.81	40.97	-3.53	0.00	0.00
42.84	11.90										
58	SEAFED	-307.11	-53.02	0.00	0.000	0.000	392.81	40.97	-3.53	0.00	0.00
42.84	11.90										

NODE TOTAL NO. STRESS (MPA)	PIPE PERCENT SECTION YIELD (PCT)	X COORD (M)	Y COORD (M)	Z COORD (M)	HORIZ ANGLE (DEG)	VERT ANGLE (DEG)	PIPE LENGTH (M)	TENSILE STRESS (MPA)	HOOP STRESS (MPA)	BENDING VERT (MPA)	STRESSES HORIZ (MPA)
1	TENSIONR	77.79	6.21	0.00	0.000	0.317	0.00	48.79	0.00	0.00	0.00
48.79	13.55										
3	LAYERAGE	71.49	6.16	0.00	0.000	0.959	6.30	48.77	0.00	-106.62	0.00
139.39	38.72										
5	LAYERAGE	65.37	5.98	0.00	0.000	2.224	12.42	48.75	0.00	-76.72	0.00
113.96	31.65										
7	LAYERAGE	59.91	5.72	0.00	0.000	3.298	17.89	48.70	0.00	-87.58	0.00
123.15	34.21										
9	LAYERAGE	53.32	5.27	0.00	0.000	4.487	24.49	48.63	0.00	-84.18	0.00
120.18	33.38										
11	LAYERAGE	47.32	4.74	0.00	0.000	5.782	30.51	48.54	0.00	-103.50	0.00
136.52	37.92										
13	LAYERAGE	38.21	3.69	0.00	0.000	7.422	39.68	48.37	0.00	-124.54	0.00
154.24	42.84										
15	LAYERAGE	29.27	2.39	0.00	0.000	9.066	48.72	48.17	0.00	-102.48	0.01
135.28	37.58										
17	LAYERAGE	23.13	1.33	0.00	0.000	10.382	54.95	48.01	0.00	-85.51	-0.07
120.69	33.52										
19	LAYERAGE	17.18	0.19	0.00	0.002	11.414	61.01	47.83	0.00	-68.29	0.32
105.84	29.40										
21	LAYERAGE	10.63	-1.23	0.00	-0.021	13.190	67.72	47.62	-0.08	-159.50	-5.53
183.30	50.92										
24	STINGER	-4.62	-5.11	0.00	0.022	15.380	83.45	47.12	-0.34	-158.88	-5.46
182.40	50.67										
26	STINGER	-11.02	-6.99	0.00	-0.004	17.155	90.12	46.90	-0.47	-66.48	-0.25
103.64	28.79										
28	STINGER	-17.37	-9.02	0.00	-0.004	18.313	96.78	46.63	-0.60	-86.38	-2.38
120.38	33.44										
30	STINGER	-23.67	-11.19	0.00	0.021	19.625	103.45	46.35	-0.75	-84.17	2.84
118.30	32.86										
32	STINGER	-29.93	-13.49	0.00	-0.096	20.830	110.12	46.06	-0.90	-73.74	-19.57
110.78	30.77										
34	STINGER	-36.14	-15.92	0.03	-0.627	21.815	116.79	45.75	-1.06	-61.29	-43.47
109.82	30.50										
36	SAGEEND	-47.27	-20.40	0.22	-1.000	21.540	128.79	45.17	-1.36	28.23	1.83
69.42	19.28										
37	SAGEEND	-58.47	-24.69	0.40	-0.852	20.287	140.79	44.62	-1.65	33.52	4.07
73.73	20.48										
38	SAGEEND	-69.77	-28.72	0.55	-0.682	18.959	152.79	44.10	-1.91	34.28	4.05
74.12	20.59										
39	SAGEEND	-81.17	-32.48	0.67	-0.519	17.608	164.79	43.61	-2.17	34.79	3.88
74.28	20.63										
40	SAGEEND	-92.65	-35.97	0.76	-0.363	16.235	176.79	43.16	-2.40	35.26	3.72
74.44	20.68										
41	SAGEEND	-104.21	-39.19	0.82	-0.215	14.840	188.79	42.74	-2.61	35.77	3.55
74.60	20.72										
42	SAGEEND	-115.85	-42.12	0.85	-0.076	13.428	200.79	42.37	-2.81	36.27	3.36
74.74	20.76										
43	SAGEEND	-127.55	-44.76	0.85	0.054	12.001	212.79	42.02	-2.98	36.70	3.13
74.85	20.79										
44	SAGEEND	-139.32	-47.11	0.83	0.173	10.558	224.79	41.72	-3.14	37.06	2.88
74.92	20.81										
45	SAGEEND	-151.14	-49.16	0.78	0.282	9.102	236.79	41.46	-3.28	37.34	2.62
74.96	20.82										
46	SAGEEND	-163.01	-50.90	0.71	0.381	7.633	248.79	41.23	-3.39	37.59	2.37
74.95	20.82										
47	SAGEEND	-174.93	-52.34	0.62	0.469	6.152	260.79	41.05	-3.49	37.82	2.18
74.91	20.81										
48	SAGEEND	-186.87	-53.48	0.51	0.552	4.664	272.79	40.91	-3.56	38.02	2.10
74.85	20.79										

49	SAGEND	-198.84	-54.29	0.39	0.633	3.170	284.79	40.80	-3.62	38.14	2.07
74.75	20.76										
50	SAGEND	-210.83	-54.80	0.25	0.708	1.680	296.79	40.74	-3.65	37.46	1.62
74.02	20.56										
51	SEABED	-222.83	-55.01	0.10	0.693	0.340	308.79	40.71	-3.66	25.52	-6.75
64.51	17.92										
52	SEABED	-234.83	-55.03	0.01	0.142	0.002	320.79	40.71	-3.66	1.26	-11.66
52.36	14.54										
53	SEABED	-246.83	-55.02	0.00	0.000	-0.001	332.79	40.71	-3.66	-0.06	-0.39
42.97	11.94										
54	SEABED	-258.83	-55.02	0.00	0.000	0.000	344.79	40.71	-3.66	0.00	0.03
42.68	11.86										
55	SEABED	-270.83	-55.02	0.00	0.000	0.000	356.79	40.71	-3.66	0.00	0.00
42.66	11.85										
56	SEABED	-282.83	-55.02	0.00	0.000	0.000	368.79	40.71	-3.66	0.00	0.00
42.66	11.85										
57	SEABED	-294.83	-55.02	0.00	0.000	0.000	380.79	40.71	-3.66	0.00	0.00
42.66	11.85										
58	SEABED	-306.83	-55.02	0.00	0.000	0.000	392.79	40.71	-3.66	0.00	0.00
42.66	11.85										

OFFPIPE - OFFSHORE PIPELINE ANALYSIS SYSTEM - VERSION 2.05 AC DATE - 5/ 6/2020 TIME - 21: 6:22
PAGE 106
PROJECT - TUGAS AKHIR JOB NO. - ANALISIS
DINPMIS
USER ID - IDA BAGUS PUNDHARA SAKYANARY LICENSED TO: RICKY TAMEKAL CASE
4

NODE	PIPE	X	Y	Z	HORIZ	VERT	PIPE	TENSILE	HOOP	BENDING	SIRESSSES
TOTAL	PERCENT										
NO.	SECTION	COORD	COORD	COORD	ANGLE	ANGLE	LENGIH	SIRESS	SIRESS	VERT	HORIZ
SIRESS	YIELD	(M)	(M)	(M)	(DEG)	(DEG)	(M)	(MPA)	(MPA)	(MPA)	(MPA)
(MPA)	(PCT)										
1	TENSIONR	77.79	6.21	0.00	0.000	0.313	0.00	48.70	0.00	0.00	0.00
48.70	13.53										
3	LAYARGE	71.49	6.16	0.00	0.000	0.955	6.30	48.68	0.00	-106.58	0.00
139.26	38.68										
5	LAYARGE	65.37	5.99	0.00	0.000	2.220	12.42	48.66	0.00	-76.68	0.00
113.83	31.62										

7	LAYARGE	59.91	5.72	0.00	0.000	3.295	17.89	48.61	0.00	-87.55	0.00
123.02	34.17										
9	LAYARGE	53.32	5.27	0.00	0.000	4.483	24.49	48.54	0.00	-84.14	0.00
120.06	33.35										
11	LAYARGE	47.32	4.74	0.00	0.000	5.779	30.51	48.45	0.00	-103.44	0.00
136.37	37.88										
13	LAYARGE	38.21	3.69	0.00	0.000	7.419	39.68	48.28	0.00	-124.45	0.00
154.06	42.79										
15	LAYARGE	29.27	2.39	0.00	0.000	9.062	48.72	48.08	0.00	-102.41	0.01
135.13	37.53										
17	LAYARGE	23.13	1.33	0.00	0.000	10.378	54.95	47.92	0.00	-85.47	-0.07
120.56	33.49										
19	LAYARGE	17.18	0.19	0.00	0.002	11.409	61.01	47.74	0.00	-68.24	0.32
105.73	29.37										
21	LAYARGE	10.63	-1.22	0.00	-0.021	13.187	67.72	47.53	-0.08	-159.46	-5.50
183.16	50.88										
24	STINGER	-4.61	-5.09	0.00	0.022	15.161	83.44	47.04	-0.34	-137.25	-5.38
163.92	45.53										
26	STINGER	-11.02	-6.94	0.00	-0.005	16.599	90.11	46.82	-0.46	-48.71	-0.51
88.44	24.57										
28	STINGER	-17.40	-8.88	0.00	0.003	17.441	96.77	46.57	-0.59	-67.37	-1.18
104.11	28.92										
30	STINGER	-23.74	-10.94	0.00	-0.009	18.445	103.44	46.30	-0.73	-67.42	-3.05
103.99	28.89										
32	STINGER	-30.05	-13.10	0.00	0.082	19.260	110.11	46.03	-0.87	-45.64	10.75
86.04	23.90										
34	STINGER	-36.32	-15.36	0.00	-0.382	20.843	116.77	45.71	-1.02	-159.03	-64.30
191.77	53.27										
36	SAGEEND	-47.46	-19.81	0.17	-1.012	21.650	128.77	45.16	-1.32	22.78	0.55
64.83	18.01										
37	SAGEEND	-58.66	-24.12	0.36	-0.879	20.461	140.77	44.60	-1.61	33.08	3.99
73.49	20.41										
38	SAGEEND	-69.94	-28.19	0.52	-0.708	19.140	152.77	44.08	-1.88	34.19	4.04
74.09	20.58										
39	SAGEEND	-81.33	-31.99	0.64	-0.544	17.789	164.77	43.59	-2.13	34.72	3.88
74.24	20.62										
40	SAGEEND	-92.79	-35.52	0.73	-0.387	16.418	176.77	43.14	-2.37	35.22	3.73
74.36	20.65										
41	SAGEEND	-104.34	-38.77	0.80	-0.238	15.028	188.77	42.72	-2.59	35.73	3.56
74.50	20.69										
42	SAGEEND	-115.97	-41.74	0.83	-0.098	13.620	200.77	42.33	-2.78	36.22	3.38
74.63	20.73										
43	SAGEEND	-127.67	-44.42	0.84	0.033	12.195	212.77	41.99	-2.96	36.64	3.16
74.71	20.75										
44	SAGEEND	-139.43	-46.81	0.82	0.154	10.753	224.77	41.68	-3.12	37.01	2.91
74.77	20.77										
45	SAGEEND	-151.24	-48.90	0.77	0.264	9.297	236.77	41.41	-3.26	37.31	2.66
74.80	20.78										
46	SAGEEND	-163.11	-50.69	0.71	0.363	7.830	248.77	41.18	-3.38	37.54	2.41
74.82	20.78										
47	SAGEEND	-175.02	-52.17	0.62	0.453	6.353	260.77	40.99	-3.48	37.76	2.21
74.84	20.79										
48	SAGEEND	-186.96	-53.34	0.52	0.536	4.867	272.77	40.84	-3.55	38.00	2.12
74.83	20.79										
49	SAGEEND	-198.93	-54.20	0.40	0.618	3.373	284.77	40.73	-3.61	38.14	2.10
74.77	20.77										
50	SAGEEND	-210.91	-54.75	0.26	0.694	1.883	296.77	40.66	-3.65	37.73	1.79
74.27	20.63										
51	SAGEEND	-222.91	-54.99	0.11	0.705	0.485	308.77	40.63	-3.66	29.78	-4.69
67.64	18.79										
52	SEABED	-234.91	-55.03	0.01	0.190	0.006	320.77	40.63	-3.66	2.14	-14.08
54.39	15.11										
53	SEABED	-246.91	-55.02	0.00	0.000	-0.001	332.77	40.63	-3.66	-0.08	-0.67
43.10	11.97										
54	SEABED	-258.91	-55.02	0.00	0.000	0.000	344.77	40.63	-3.66	0.00	0.04
42.61	11.84										
55	SEABED	-270.91	-55.02	0.00	0.000	0.000	356.77	40.63	-3.66	0.00	0.00
42.58	11.83										
56	SEABED	-282.91	-55.02	0.00	0.000	0.000	368.77	40.63	-3.66	0.00	0.00
42.58	11.83										

57	SEABED	-294.91	-55.02	0.00	0.000	0.000	380.77	40.63	-3.66	0.00	0.00
42.58	11.83										
58	SEABED	-306.91	-55.02	0.00	0.000	0.000	392.77	40.63	-3.66	0.00	0.00
42.58	11.83										
59	SEABED	-318.91	-55.02	0.00	0.000	0.000	404.77	40.63	-3.66	0.00	0.00
42.58	11.83										

OFFPIPE - OFFSHORE PIPELINE ANALYSIS SYSTEM - VERSION 2.05 AC DATE - 5/ 6/2020 TIME - 21: 6:22
PAGE 106
PROJECT - TUGAS AKHIR JOB NO. - ANALISIS
DINAMIS
USER ID - IDA BAGUS PUNDHARA SARZANARY LICENSED TO: RICKY TAWKAL CASE
5

NODE	PIPE	X	Y	Z	HORIZ	VERT	PIPE	TENSILE	HOOP	BENDING	SIRESSSES
TOTAL	PERONT	COORD	COORD	COORD	ANGLE	ANGLE	LENGIH	SIRESS	SIRESS	VERT	HORIZ
SIRESS	YIELD	(M)	(M)	(M)	(DEG)	(DEG)	(M)	(MPA)	(MPA)	(MPA)	(MPA)
(MPA)	(PCT)										
1	TENSIONR	77.79	6.21	0.00	0.000	0.317	0.00	56.94	0.00	0.00	0.00
56.94	15.82										
3	LAYARGE	71.49	6.16	0.00	0.000	0.957	6.30	56.92	0.00	-109.07	0.00
149.63	41.56										
5	LAYARGE	65.38	5.98	0.00	0.000	2.218	12.42	56.90	0.00	-78.87	0.00
123.94	34.43										
7	LAYARGE	59.91	5.72	0.00	0.000	3.297	17.89	56.86	0.00	-89.87	0.00
133.25	37.01										
9	LAYARGE	53.32	5.27	0.00	0.000	4.482	24.49	56.79	0.00	-86.52	0.00
130.34	36.20										
11	LAYARGE	47.32	4.74	0.00	0.000	5.785	30.51	56.70	0.00	-107.28	0.00
147.88	41.08										
13	LAYARGE	38.21	3.69	0.00	0.000	7.419	39.68	56.53	0.00	-129.92	0.00
166.96	46.38										
15	LAYARGE	29.27	2.39	0.00	0.000	9.058	48.72	56.33	0.00	-106.29	0.01
146.68	40.74										
17	LAYARGE	23.13	1.33	0.00	0.000	10.379	54.95	56.17	0.00	-87.70	-0.06
130.71	36.31										
19	LAYARGE	17.18	0.19	0.00	0.001	11.408	61.01	55.99	0.00	-69.92	0.25
115.42	32.06										

21	LAVARGE	10.63	-1.22	0.00	-0.020	13.213	67.72	55.77	-0.08	-168.94	-5.33
199.47	55.41										
24	STINGER	-4.64	-5.13	0.00	0.011	15.778	83.47	55.26	-0.34	-212.93	-6.62
236.49	65.69										
26	STINGER	-11.01	-7.10	0.00	0.034	18.269	90.14	55.04	-0.47	-106.51	6.71
145.93	40.54										
28	STINGER	-17.30	-9.29	0.00	-0.179	20.014	96.81	54.75	-0.62	-122.21	-35.17
162.43	45.12										
30	STINGER	-23.54	-11.65	0.05	-0.752	21.285	103.47	54.46	-0.78	-52.09	-35.36
108.09	30.02										
32	STINGER	-29.74	-14.09	0.15	-1.046	21.411	110.14	54.15	-0.94	16.97	-1.92
68.66	19.07										
34	STINGER	-35.96	-16.50	0.27	-1.013	20.909	116.81	53.84	-1.10	26.43	3.03
76.61	21.28										
36	SAGEEND	-47.21	-20.67	0.45	-0.866	19.818	128.81	53.30	-1.38	28.41	3.66
78.00	21.67										
37	SAGEEND	-58.53	-24.63	0.61	-0.717	18.693	140.81	52.79	-1.64	28.87	3.57
78.09	21.69										
38	SAGEEND	-69.94	-28.37	0.74	-0.572	17.554	152.81	52.30	-1.89	29.23	3.45
78.12	21.70										
39	SAGEEND	-81.41	-31.87	0.84	-0.434	16.400	164.81	51.85	-2.13	29.58	3.30
78.15	21.71										
40	SAGEEND	-92.96	-35.14	0.91	-0.302	15.233	176.81	51.43	-2.34	29.93	3.18
78.18	21.72										
41	SAGEEND	-104.57	-38.17	0.96	-0.176	14.054	188.81	51.04	-2.55	30.27	3.05
78.20	21.72										
42	SAGEEND	-116.24	-40.97	0.98	-0.056	12.862	200.81	50.68	-2.73	30.60	2.90
78.20	21.72										
43	SAGEEND	-127.97	-43.51	0.98	0.056	11.658	212.81	50.35	-2.90	30.89	2.73
78.20	21.72										
44	SAGEEND	-139.74	-45.81	0.96	0.161	10.443	224.81	50.05	-3.05	31.13	2.53
78.17	21.71										
45	SAGEEND	-151.57	-47.86	0.92	0.257	9.220	236.81	49.79	-3.19	31.33	2.34
78.14	21.71										
46	SAGEEND	-163.43	-49.66	0.86	0.346	7.989	248.81	49.56	-3.31	31.50	2.14
78.09	21.69										
47	SAGEEND	-175.33	-51.20	0.77	0.426	6.750	260.81	49.36	-3.41	31.68	1.96
78.03	21.67										
48	SAGEEND	-187.26	-52.48	0.68	0.500	5.503	272.81	49.20	-3.50	31.84	1.82
77.95	21.65										
49	SAGEEND	-199.22	-53.50	0.57	0.569	4.251	284.81	49.07	-3.56	31.98	1.77
77.88	21.63										
50	SAGEEND	-211.19	-54.26	0.44	0.638	2.993	296.81	48.97	-3.61	32.07	1.76
77.80	21.61										
51	SAGEEND	-223.18	-54.75	0.30	0.704	1.738	308.81	48.91	-3.65	31.90	1.60
77.52	21.53										
52	SAGEEND	-235.18	-54.99	0.15	0.735	0.532	320.81	48.88	-3.66	27.38	-2.00
73.64	20.45										
53	SEABED	-247.18	-55.02	0.03	0.327	0.018	332.81	48.87	-3.66	2.99	-14.34
63.01	17.50										
54	SEABED	-259.18	-55.02	0.00	0.013	-0.001	344.81	48.87	-3.66	-0.02	-1.96
52.38	14.55										
55	SEABED	-271.18	-55.02	0.00	0.000	0.000	356.81	48.87	-3.66	-0.01	0.01
50.81	14.11										
56	SEABED	-283.18	-55.02	0.00	0.000	0.000	368.81	48.87	-3.66	0.00	0.00
50.81	14.11										
57	SEABED	-295.18	-55.02	0.00	0.000	0.000	380.81	48.87	-3.66	0.00	0.00
50.81	14.11										
58	SEABED	-307.18	-55.02	0.00	0.000	0.000	392.81	48.87	-3.66	0.00	0.00
50.81	14.11										
59	SEABED	-319.18	-55.02	0.00	0.000	0.000	404.81	48.87	-3.66	0.00	0.00
50.81	14.11										

OFFPIPE - OFFSHORE PIPELINE ANALYSIS SYSTEM - VERSION 2.05 AC DATE - 5/ 6/2020 TIME - 21: 6:22
 PAGE 106
 PROJECT - TUGAS AKHIR JOB NO. - ANALISIS
 DINFMIS
 USER ID - IDA BAGUS FUNDHARA SAKYANARY LICENSED TO: RICKY TAWKAL CASE
 6

NODE TOTAL	PIPE BEFORE NO. SECTION SIRESS (MPA)	X COORD (M)	Y COORD (M)	Z COORD (M)	HORIZ ANGLE (DEG)	VERT ANGLE (DEG)	PIPE LENGIH (M)	TENSILE SIRESS (MPA)	HOOP SIRESS (MPA)	BENDING VERT (MPA)	SIRESS HORIZ (MPA)
1	TENSIONR 56.84 15.79	77.79	6.21	0.00	0.000	0.318	0.00	56.84	0.00	0.00	0.00
3	LAYFARGE 149.51 41.53	71.49	6.16	0.00	0.000	0.958	6.30	56.82	0.00	-109.05	0.00
5	LAYFARGE 123.81 34.39	65.37	5.98	0.00	0.000	2.220	12.42	56.80	0.00	-78.84	0.00
7	LAYFARGE 133.13 36.98	59.91	5.72	0.00	0.000	3.299	17.89	56.76	0.00	-89.85	0.00
9	LAYFARGE 130.21 36.17	53.32	5.27	0.00	0.000	4.483	24.49	56.69	0.00	-86.50	0.00
11	LAYFARGE 147.75 41.04	47.32	4.74	0.00	0.000	5.787	30.51	56.60	0.00	-107.24	0.00
13	LAYFARGE 166.81 46.34	38.21	3.69	0.00	0.000	7.420	39.68	56.43	0.00	-129.87	0.00
15	LAYFARGE 146.54 40.71	29.27	2.39	0.00	0.000	9.059	48.72	56.23	0.00	-106.26	0.01
17	LAYFARGE 130.57 36.27	23.13	1.33	0.00	0.000	10.380	54.95	56.07	0.00	-87.66	-0.06
19	LAYFARGE 115.43 32.06	17.18	0.19	0.00	0.001	11.410	61.01	55.89	0.00	-70.06	0.28
21	LAYFARGE 198.71 55.20	10.63	-1.22	0.00	-0.020	13.211	67.72	55.67	-0.08	-168.18	-5.40
24	STINGER 197.87 54.96	-4.62	-5.11	0.00	0.022	15.356	83.45	55.17	-0.34	-167.63	-5.18
26	STINGER 112.94 31.37	-11.01	-6.99	0.00	-0.008	17.152	90.12	54.96	-0.47	-67.94	-1.09
28	STINGER 132.77 36.88	-17.37	-9.02	0.00	0.015	18.324	96.78	54.69	-0.60	-91.52	1.46
30	STINGER 120.43 33.45	-23.67	-11.19	0.00	-0.067	19.565	103.45	54.41	-0.75	-76.31	-14.80
32	STINGER 127.43 35.40	-29.93	-13.48	0.03	-0.569	20.622	110.12	54.12	-0.90	-71.37	-47.64
34	STINGER 66.25 18.40	-36.16	-15.86	0.12	-0.991	20.935	116.79	53.82	-1.06	13.98	-3.89

36	SAGEBND	-47.40	-20.06	0.31	-0.916	19.974	128.79	53.28	-1.34	27.75	3.35
77.43	21.51										
37	SAGEBND	-58.71	-24.05	0.48	-0.770	18.861	140.79	52.76	-1.60	28.82	3.57
78.03	21.67										
38	SAGEBND	-70.11	-27.82	0.62	-0.624	17.726	152.79	52.28	-1.85	29.19	3.47
78.05	21.68										
39	SAGEBND	-81.57	-31.36	0.73	-0.485	16.576	164.79	51.82	-2.09	29.55	3.34
78.05	21.68										
40	SAGEBND	-93.11	-34.66	0.81	-0.352	15.410	176.79	51.40	-2.31	29.86	3.20
78.06	21.68										
41	SAGEBND	-104.71	-37.73	0.87	-0.225	14.234	188.79	51.00	-2.52	30.20	3.08
78.07	21.69										
42	SAGEBND	-116.37	-40.56	0.90	-0.104	13.043	200.79	50.64	-2.70	30.55	2.94
78.07	21.69										
43	SAGEBND	-128.09	-43.15	0.91	0.010	11.840	212.79	50.30	-2.88	30.87	2.77
78.07	21.68										
44	SAGEBND	-139.86	-45.49	0.90	0.115	10.628	224.79	50.00	-3.03	31.12	2.58
78.06	21.68										
45	SAGEBND	-151.67	-47.57	0.87	0.214	9.405	236.79	49.73	-3.17	31.34	2.39
78.04	21.68										
46	SAGEBND	-163.53	-49.41	0.81	0.304	8.173	248.79	49.50	-3.29	31.51	2.19
78.01	21.67										
47	SAGEBND	-175.43	-50.98	0.74	0.386	6.934	260.79	49.30	-3.40	31.66	1.99
77.97	21.66										
48	SAGEBND	-187.35	-52.30	0.65	0.460	5.687	272.79	49.13	-3.49	31.81	1.84
77.92	21.64										
49	SAGEBND	-199.31	-53.36	0.55	0.529	4.436	284.79	48.99	-3.56	31.96	1.78
77.86	21.63										
50	SAGEBND	-211.28	-54.16	0.43	0.598	3.181	296.79	48.89	-3.61	32.06	1.78
77.78	21.61										
51	SAGEBND	-223.27	-54.69	0.30	0.664	1.927	308.79	48.82	-3.64	32.00	1.66
77.57	21.55										
52	SAGEBND	-235.26	-54.97	0.16	0.703	0.698	320.79	48.79	-3.66	29.10	-1.25
75.04	20.84										
53	SEABED	-247.26	-55.02	0.03	0.375	0.033	332.79	48.78	-3.66	4.71	-13.97
62.92	17.48										
54	SEABED	-259.26	-55.02	0.00	0.018	-0.001	344.79	48.78	-3.66	0.04	-2.57
52.77	14.66										
55	SEABED	-271.26	-55.02	0.00	-0.001	0.000	356.79	48.78	-3.66	-0.01	-0.02
50.73	14.09										
56	SEABED	-283.26	-55.02	0.00	0.000	0.000	368.79	48.78	-3.66	0.00	0.01
50.72	14.09										
57	SEABED	-295.26	-55.02	0.00	0.000	0.000	380.79	48.78	-3.66	0.00	0.00
50.71	14.09										
58	SEABED	-307.26	-55.02	0.00	0.000	0.000	392.79	48.78	-3.66	0.00	0.00
50.71	14.09										
59	SEABED	-319.26	-55.02	0.00	0.000	0.000	404.79	48.78	-3.66	0.00	0.00
50.71	14.09										
60	SEABED	-331.26	-55.02	0.00	0.000	0.000	416.79	48.78	-3.66	0.00	0.00
50.71	14.09										

NODE TOTAL NO. STRESS (MPA)	PIPE PERCENT SECTION YIELD (PCT)	X COORD (M)	Y COORD (M)	Z COORD (M)	HORIZ ANGLE (DEG)	VERT ANGLE (DEG)	PIPE LENGTH (M)	TENSILE STRESS (MPA)	HOOP STRESS (MPA)	BENDING VERT STRESS (MPA)	SIRESSSES HORIZ (MPA)
1	TENSIONR	77.79	6.21	0.00	0.000	0.318	0.00	56.84	0.00	0.00	0.00
56.84	15.79										
3	LAYARGE	71.49	6.16	0.00	0.000	0.958	6.30	56.82	0.00	-109.02	0.00
149.48	41.52										
5	LAYARGE	65.37	5.99	0.00	0.000	2.219	12.42	56.80	0.00	-78.83	0.00
123.80	34.39										
7	LAYARGE	59.91	5.72	0.00	0.000	3.298	17.89	56.75	0.00	-89.83	0.00
133.11	36.97										
9	LAYARGE	53.32	5.27	0.00	0.000	4.483	24.49	56.68	0.00	-86.48	0.00
130.19	36.16										
11	LAYARGE	47.32	4.74	0.00	0.000	5.786	30.51	56.59	0.00	-107.21	0.00
147.72	41.03										
13	LAYARGE	38.21	3.69	0.00	0.000	7.420	39.68	56.42	0.00	-129.84	0.00
166.78	46.33										
15	LAYARGE	29.27	2.39	0.00	0.000	9.059	48.72	56.22	0.00	-106.24	0.01
146.53	40.70										
17	LAYARGE	23.13	1.33	0.00	0.000	10.380	54.95	56.06	0.00	-87.63	-0.06
130.54	36.26										
19	LAYARGE	17.18	0.19	0.00	0.001	11.410	61.01	55.88	0.00	-70.12	0.28
115.46	32.07										
21	LAYARGE	10.63	-1.22	0.00	-0.020	13.209	67.72	55.67	-0.08	-167.89	-5.38
198.48	55.13										
24	STINGER	-4.61	-5.09	0.00	0.020	15.143	83.44	55.18	-0.34	-144.80	-5.30
178.49	49.58										
26	STINGER	-11.02	-6.94	0.00	-0.004	16.602	90.11	54.96	-0.46	-50.02	-0.39
97.71	27.14										
28	STINGER	-17.40	-8.88	0.00	-0.001	17.444	96.77	54.70	-0.59	-69.79	-1.97
114.34	31.76										
30	STINGER	-23.74	-10.94	0.00	0.011	18.439	103.44	54.44	-0.73	-68.27	1.11
112.82	31.34										
32	STINGER	-30.05	-13.10	0.00	-0.051	19.314	110.11	54.16	-0.87	-55.37	-12.07
102.32	28.42										
34	STINGER	-36.32	-15.35	0.02	-0.539	20.196	116.77	53.87	-1.02	-71.44	-48.96
127.71	35.48										
36	SAGEEND	-47.57	-19.53	0.20	-0.940	20.077	128.77	53.34	-1.30	23.73	1.25
73.82	20.51										
37	SAGEEND	-58.87	-23.55	0.37	-0.816	19.007	140.77	52.82	-1.57	28.59	3.49
77.80	21.61										
38	SAGEEND	-70.26	-27.34	0.52	-0.672	17.872	152.77	52.33	-1.82	29.18	3.48
78.00	21.67										
39	SAGEEND	-81.71	-30.91	0.64	-0.532	16.723	164.77	51.87	-2.06	29.55	3.35
78.01	21.67										
40	SAGEEND	-93.24	-34.25	0.73	-0.398	15.562	176.77	51.44	-2.28	29.86	3.21
78.02	21.67										
41	SAGEEND	-104.83	-37.35	0.80	-0.270	14.387	188.77	51.04	-2.49	30.16	3.08
78.04	21.68										

42	SAGEEND	-116.49	-40.21	0.84	-0.149	13.198	200.77	50.67	-2.68	30.50	2.95
78.06	21.68										
43	SAGEEND	-128.20	-42.82	0.86	-0.034	11.996	212.77	50.33	-2.86	30.84	2.78
78.07	21.69										
44	SAGEEND	-139.96	-45.19	0.86	0.073	10.786	224.77	50.03	-3.01	31.12	2.60
78.08	21.69										
45	SAGEEND	-151.77	-47.31	0.83	0.172	9.564	236.77	49.75	-3.15	31.34	2.41
78.07	21.69										
46	SAGEEND	-163.62	-49.18	0.79	0.263	8.334	248.77	49.51	-3.28	31.52	2.20
78.04	21.68										
47	SAGEEND	-175.52	-50.79	0.72	0.346	7.096	260.77	49.31	-3.39	31.65	2.01
77.99	21.66										
48	SAGEEND	-187.44	-52.15	0.64	0.421	5.852	272.77	49.14	-3.48	31.81	1.85
77.93	21.65										
49	SAGEEND	-199.39	-53.24	0.55	0.490	4.603	284.77	49.00	-3.55	31.95	1.78
77.87	21.63										
50	SAGEEND	-211.36	-54.07	0.44	0.559	3.346	296.77	48.89	-3.60	32.06	1.77
77.80	21.61										
51	SAGEEND	-223.34	-54.64	0.32	0.626	2.087	308.77	48.82	-3.64	32.03	1.71
77.64	21.57										
52	SAGEEND	-235.34	-54.95	0.18	0.681	0.851	320.77	48.78	-3.66	30.04	0.53
75.80	21.05										
53	SEALED	-247.34	-55.02	0.05	0.476	0.057	332.77	48.77	-3.66	6.94	-12.97
62.65	17.40										
54	SEALED	-259.34	-55.03	0.00	0.036	-0.001	344.77	48.77	-3.66	0.12	-4.16
54.10	15.03										
55	SEALED	-271.34	-55.02	0.00	0.000	0.000	356.77	48.77	-3.66	-0.01	-0.08
50.76	14.10										
56	SEALED	-283.34	-55.02	0.00	0.000	0.000	368.77	48.77	-3.66	0.00	0.01
50.71	14.09										
57	SEALED	-295.34	-55.02	0.00	0.000	0.000	380.77	48.77	-3.66	0.00	0.00
50.70	14.08										
58	SEALED	-307.34	-55.02	0.00	0.000	0.000	392.77	48.77	-3.66	0.00	0.00
50.70	14.08										
59	SEALED	-319.34	-55.02	0.00	0.000	0.000	404.77	48.77	-3.66	0.00	0.00
50.70	14.08										
60	SEALED	-331.34	-55.02	0.00	0.000	0.000	416.77	48.77	-3.66	0.00	0.00
50.70	14.08										

NODE	PIPE	X	Y	Z	HORIZ	VERT	PIPE	TENSILE	HOOP	ENDING STRESSES	
TOTAL	PERCENT										
NO.	SECTION	COORD	COORD	COORD	ANGLE	ANGLE	LENGTH	STRESS	STRESS	VERT	HORIZ
STRESS	YIELD	(M)	(M)	(M)	(DEG)	(DEG)	(M)	(MPA)	(MPA)	(MPA)	(MPA)
(MPA)	(PCT)										
1	TENSIONR	77.79	6.21	0.00	0.000	0.321	0.00	65.02	0.00	0.00	0.00
65.02	18.06										
3	LAYERGE	71.49	6.16	0.00	0.000	0.960	6.30	65.00	0.00	-111.47	0.00
159.73	44.37										
5	LAYERGE	65.37	5.99	0.00	0.000	2.218	12.42	64.98	0.00	-80.98	0.00
133.81	37.17										
7	LAYERGE	59.91	5.72	0.00	0.000	3.300	17.89	64.93	0.00	-92.12	0.00
143.23	39.79										
9	LAYERGE	53.32	5.28	0.00	0.000	4.481	24.49	64.86	0.00	-88.85	0.00
140.38	38.99										
11	LAYERGE	47.32	4.74	0.00	0.000	5.792	30.51	64.77	0.00	-111.00	0.00
159.12	44.20										
13	LAYERGE	38.21	3.69	0.00	0.000	7.419	39.68	64.60	0.00	-135.22	0.00
179.53	49.87										
15	LAYERGE	29.27	2.39	0.00	0.000	9.054	48.72	64.40	0.00	-110.07	0.01
157.96	43.88										
17	LAYERGE	23.13	1.33	0.00	0.000	10.380	54.95	64.24	0.00	-89.90	-0.05
140.64	39.07										
19	LAYERGE	17.18	0.19	0.00	0.001	11.408	61.01	64.06	0.00	-71.61	0.22
124.91	34.70										
21	LAYERGE	10.63	-1.23	0.00	-0.019	13.239	67.72	63.85	-0.08	-178.35	-5.25
215.52	59.87										
24	STINGER	-4.64	-5.13	0.00	0.015	15.754	83.47	63.33	-0.34	-224.05	-5.92
253.99	70.55										
26	STINGER	-11.01	-7.11	0.00	0.018	18.269	90.14	63.11	-0.47	-109.55	5.21
156.51	43.47										
28	STINGER	-17.31	-9.28	0.01	-0.454	19.840	96.81	62.83	-0.62	-107.16	-63.34
168.75	46.87										
30	STINGER	-23.56	-11.60	0.10	-1.006	20.475	103.47	62.55	-0.77	8.11	-5.13
70.80	19.67										
32	STINGER	-29.81	-13.91	0.21	-1.007	20.092	110.14	62.25	-0.93	22.38	2.37
81.64	22.68										
34	STINGER	-36.08	-16.18	0.32	-0.940	19.576	116.81	61.95	-1.08	24.35	3.20
83.17	23.10										
36	SAGEHD	-47.42	-20.10	0.49	-0.807	18.609	128.81	61.45	-1.34	24.91	3.22
83.30	23.14										
37	SAGEHD	-58.82	-23.83	0.64	-0.677	17.630	140.81	60.97	-1.59	25.18	3.12
83.21	23.11										
38	SAGEHD	-70.29	-27.37	0.76	-0.551	16.637	152.81	60.51	-1.83	25.43	3.02
83.12	23.09										
39	SAGEHD	-81.81	-30.70	0.86	-0.430	15.634	164.81	60.08	-2.05	25.67	2.91
83.04	23.07										
40	SAGEHD	-93.40	-33.83	0.94	-0.314	14.622	176.81	59.68	-2.26	25.91	2.80
82.95	23.04										
41	SAGEHD	-105.04	-36.76	0.99	-0.203	13.599	188.81	59.30	-2.45	26.17	2.70
82.87	23.02										
42	SAGEHD	-116.72	-39.48	1.02	-0.097	12.568	200.81	58.95	-2.63	26.43	2.59
82.80	23.00										
43	SAGEHD	-128.46	-41.98	1.03	0.004	11.528	212.81	58.63	-2.80	26.66	2.47
82.74	22.98										
44	SAGEHD	-140.24	-44.27	1.02	0.099	10.482	224.81	58.33	-2.95	26.87	2.32
82.68	22.97										
45	SAGEHD	-152.06	-46.35	0.99	0.187	9.426	236.81	58.07	-3.09	27.03	2.15
82.63	22.95										
46	SAGEHD	-163.91	-48.20	0.94	0.269	8.364	248.81	57.83	-3.21	27.15	2.00
82.57	22.94										
47	SAGEHD	-175.80	-49.84	0.88	0.344	7.297	260.81	57.62	-3.32	27.26	1.84
82.52	22.92										

48	SAGEEND	-187.72	-51.25	0.80	0.413	6.225	272.81	57.44	-3.42	27.37	1.69
82.45	22.90										
49	SAGEEND	-199.66	-52.44	0.71	0.477	5.149	284.81	57.28	-3.49	27.51	1.58
82.37	22.88										
50	SAGEEND	-211.62	-53.40	0.60	0.536	4.070	296.81	57.16	-3.56	27.61	1.54
82.31	22.86										
51	SAGEEND	-223.60	-54.14	0.48	0.595	2.987	308.81	57.07	-3.61	27.68	1.55
82.23	22.84										
52	SAGEEND	-235.58	-54.65	0.35	0.653	1.904	320.81	57.00	-3.64	27.68	1.52
82.10	22.81										
53	SAGEEND	-247.58	-54.94	0.21	0.703	0.832	332.81	56.96	-3.66	26.35	0.71
80.89	22.47										
54	SEAFED	-259.58	-55.02	0.07	0.558	0.076	344.81	56.96	-3.66	7.73	-10.91
69.57	19.32										
55	SEAFED	-271.58	-55.02	0.00	0.080	0.001	356.81	56.95	-3.66	0.31	-7.05
64.62	17.95										
56	SEAFED	-283.58	-55.02	0.00	0.001	0.000	368.81	56.95	-3.66	-0.01	-0.36
59.15	16.43										
57	SEAFED	-295.58	-55.02	0.00	0.000	0.000	380.81	56.96	-3.66	0.00	0.00
58.88	16.35										
58	SEAFED	-307.58	-55.02	0.00	0.000	0.000	392.81	56.96	-3.66	0.00	0.00
58.87	16.35										
59	SEAFED	-319.58	-55.02	0.00	0.000	0.000	404.81	56.96	-3.66	0.00	0.00
58.87	16.35										
60	SEAFED	-331.58	-55.02	0.00	0.000	0.000	416.81	56.96	-3.66	0.00	0.00
58.87	16.35										

OFFPIPE - OFFSHORE PIPELINE ANALYSIS SYSTEM - VERSION 2.05 AC DATE - 5/ 6/2020 TIME - 21: 6:22
PAGE 106
PROJECT - TUGAS AKHIR JOB NO. - ANALISIS
DINPMIS
USER ID - IDA BAGUS PUNDHARA SARYANARY LICENSED TO: RICKY TAMEKAL CASE
9

NODE TOTAL NO. STRESS (MPA)	PIPE PERCENT SECTION YIELD (PCT)	X	Y	Z	HORIZ	VERT	PIPE	TENSILE	HOOP	BENDING	SIRESSSES
		COORD (M)	COORD (M)	COORD (M)	ANGLE (DEG)	ANGLE (DEG)	LENGIH (M)	STRESS (MPA)	STRESS (MPA)	VERT (MPA)	HORIZ (MPA)
1 65.04	TENSIONR 18.07	77.79	6.21	0.00	0.000	0.321	0.00	65.04	0.00	0.00	0.00

3	LAYFARGE	71.49	6.16	0.00	0.000	0.959	6.30	65.02	0.00	-111.47	0.00
159.74	44.37										
5	LAYFARGE	65.37	5.98	0.00	0.000	2.217	12.42	64.99	0.00	-80.98	0.00
133.81	37.17										
7	LAYFARGE	59.91	5.72	0.00	0.000	3.300	17.89	64.95	0.00	-92.12	0.00
143.24	39.79										
9	LAYFARGE	53.32	5.27	0.00	0.000	4.481	24.49	64.88	0.00	-88.85	0.00
140.39	39.00										
11	LAYFARGE	47.32	4.74	0.00	0.000	5.791	30.51	64.79	0.00	-111.00	0.00
159.12	44.20										
13	LAYFARGE	38.21	3.69	0.00	0.000	7.419	39.68	64.62	0.00	-135.22	0.00
179.54	49.87										
15	LAYFARGE	29.27	2.39	0.00	0.000	9.054	48.72	64.42	0.00	-110.09	0.01
157.98	43.88										
17	LAYFARGE	23.13	1.33	0.00	0.000	10.379	54.95	64.26	0.00	-89.82	-0.05
140.60	39.05										
19	LAYFARGE	17.18	0.19	0.00	0.001	11.409	61.01	64.08	0.00	-71.95	0.23
125.21	34.78										
21	LAYFARGE	10.63	-1.22	0.00	-0.019	13.231	67.72	63.87	-0.08	-176.82	-5.30
214.26	59.52										
24	STINGER	-4.62	-5.11	0.00	0.019	15.333	83.45	63.37	-0.34	-175.91	-5.31
213.11	59.20										
26	STINGER	-11.02	-6.99	0.00	-0.002	17.160	90.12	63.15	-0.47	-71.42	-0.43
124.07	34.46										
28	STINGER	-17.37	-9.02	0.00	-0.009	18.290	96.78	62.89	-0.60	-88.80	-4.71
138.58	38.49										
30	STINGER	-23.67	-11.18	0.01	-0.424	19.471	103.45	62.61	-0.75	-77.79	-48.91
140.87	39.13										
32	STINGER	-29.95	-13.44	0.10	-0.905	19.960	110.12	62.33	-0.90	-4.20	-12.39
73.46	20.41										
34	STINGER	-36.22	-15.70	0.20	-0.964	19.659	116.79	62.03	-1.05	21.46	1.73
80.49	22.36										
36	SAGEEND	-47.55	-19.65	0.38	-0.846	18.721	128.79	61.53	-1.31	24.78	3.19
83.10	23.08										
37	SAGEEND	-58.94	-23.41	0.53	-0.717	17.743	140.79	61.04	-1.56	25.20	3.16
83.16	23.10										
38	SAGEEND	-70.40	-26.96	0.67	-0.590	16.753	152.79	60.59	-1.80	25.45	3.06
83.09	23.08										
39	SAGEEND	-81.92	-30.32	0.77	-0.468	15.752	164.79	60.15	-2.02	25.67	2.94
83.01	23.06										
40	SAGEEND	-93.50	-33.48	0.85	-0.352	14.740	176.79	59.75	-2.23	25.91	2.82
82.94	23.04										
41	SAGEEND	-105.13	-36.43	0.91	-0.241	13.720	188.79	59.37	-2.43	26.15	2.73
82.89	23.02										
42	SAGEEND	-116.81	-39.17	0.95	-0.134	12.690	200.79	59.02	-2.61	26.43	2.62
82.86	23.02										
43	SAGEEND	-128.54	-41.70	0.97	-0.032	11.651	212.79	58.69	-2.78	26.67	2.50
82.83	23.01										
44	SAGEEND	-140.32	-44.02	0.97	0.064	10.604	224.79	58.39	-2.94	26.88	2.36
82.79	23.00										
45	SAGEEND	-152.13	-46.12	0.94	0.153	9.551	236.79	58.12	-3.08	27.05	2.19
82.73	22.98										
46	SAGEEND	-163.98	-48.00	0.90	0.235	8.490	248.79	57.88	-3.20	27.17	2.04
82.65	22.96										
47	SAGEEND	-175.87	-49.66	0.85	0.312	7.422	260.79	57.67	-3.31	27.28	1.87
82.55	22.93										
48	SAGEEND	-187.78	-51.10	0.77	0.382	6.350	272.79	57.48	-3.41	27.37	1.71
82.47	22.91										
49	SAGEEND	-199.72	-52.31	0.69	0.446	5.275	284.79	57.33	-3.49	27.48	1.60
82.39	22.89										
50	SAGEEND	-211.68	-53.30	0.59	0.505	4.196	296.79	57.20	-3.55	27.58	1.55
82.31	22.86										
51	SAGEEND	-223.65	-54.07	0.48	0.564	3.112	308.79	57.10	-3.60	27.66	1.55
82.23	22.84										
52	SAGEEND	-235.64	-54.61	0.35	0.623	2.029	320.79	57.04	-3.64	27.67	1.53
82.10	22.81										
53	SAGEEND	-247.63	-54.92	0.22	0.675	0.955	332.79	56.99	-3.66	26.67	0.95
81.20	22.56										
54	SEABED	-259.63	-55.02	0.08	0.588	0.114	344.79	56.98	-3.66	10.55	-9.64
70.18	19.49										

55	SEABED	-271.63	-55.02	0.01	0.105	0.002	356.79	56.98	-3.66	0.52	-8.61
65.96	18.32										
56	SEABED	-283.63	-55.02	0.00	0.002	0.000	368.79	56.98	-3.66	-0.01	-0.50
59.31	16.48										
57	SEABED	-295.63	-55.02	0.00	0.000	0.000	380.79	56.98	-3.66	0.00	0.00
58.90	16.36										
58	SEABED	-307.63	-55.02	0.00	0.000	0.000	392.79	56.98	-3.66	0.00	0.00
58.90	16.36										
59	SEABED	-319.63	-55.02	0.00	0.000	0.000	404.79	56.98	-3.66	0.00	0.00
58.90	16.36										
60	SEABED	-331.63	-55.02	0.00	0.000	0.000	416.79	56.98	-3.66	0.00	0.00
58.90	16.36										

GRAFIK ANALISA DINAMIS HEADING 90°

MAXIMUM DYNAMIC STRESS

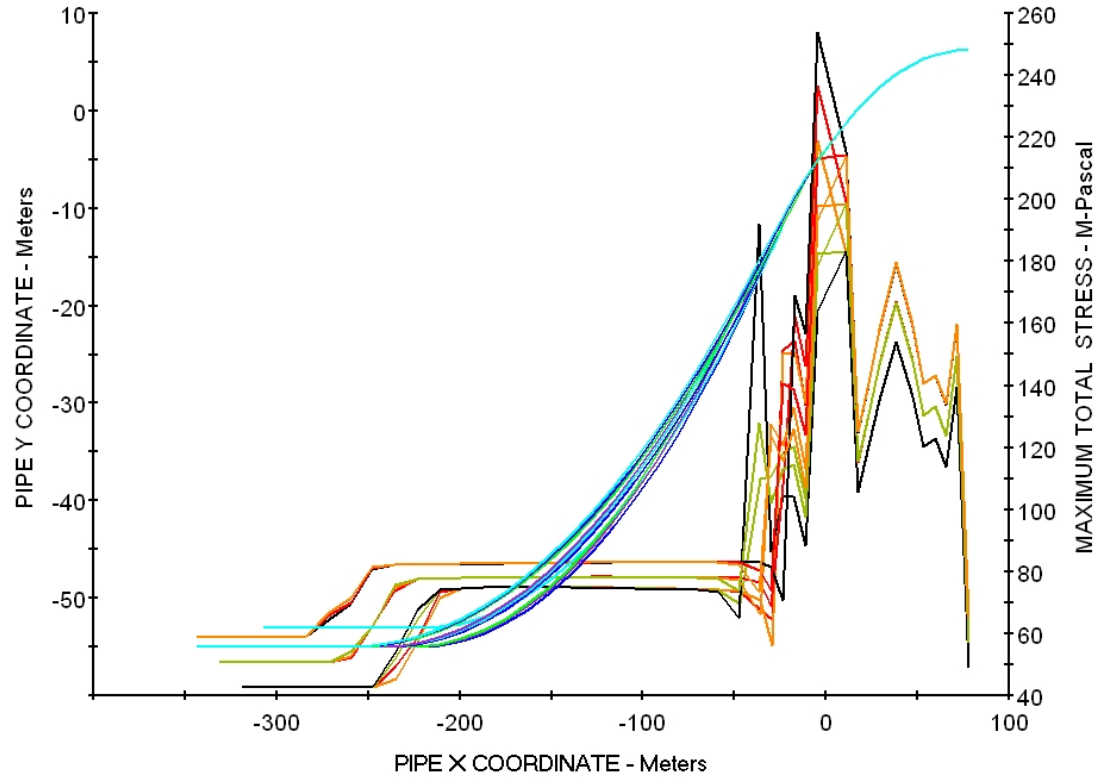

OUTPUT REGANGAN ANALISA DINAMIS HEADING 90°

SOLUTION SUMMARY									
NODE	PIPE	X	Y	Z	SUPPORT	REACT	TOTAL	TOTAL	PCT
NO.	SECTION	COORD	COORD	COORD	VERT	HORIZ	MOMENT	STRAIN	ALL
		(M)	(M)	(M)	(KN)	(KN)	(KN-M)	(PCT)	(%)
1	TENSIONR	77.8	6.2	0.0	-2.6	-0.1	0.0	0.028	0.
3	LAYBARGE	71.5	6.2	0.0	23.6	0.1	47.0	0.064	0.
5	LAYBARGE	65.4	6.0	0.0	10.2	0.0	33.9	0.049	0.
7	LAYBARGE	59.9	5.7	0.0	14.7	0.0	38.3	0.074	0.
9	LAYBARGE	53.3	5.3	0.0	13.2	0.0	36.9	0.052	0.
11	LAYBARGE	47.3	4.7	0.0	17.4	0.0	42.1	0.078	0.
13	LAYBARGE	38.2	3.7	0.0	21.7	-0.1	47.6	0.055	0.

15	LAYBARGE	29.3	2.4	0.0	17.1	0.1	41.7	0.038	0.
17	LAYBARGE	23.1	1.3	0.0	13.8	-0.1	37.5	0.063	0.
19	LAYBARGE	17.2	0.2	0.0	8.5	-0.1	32.7	0.057	0.
21	LAYBARGE	10.6	-1.2	0.0	21.1	-1.7	54.7	0.043	0.
24	STINGER	-4.6	-5.1	0.0	27.2	-1.5	74.4	0.103	0.
26	STINGER	-11.0	-7.1	0.0	8.9	-1.6	48.1	0.065	0.
28	STINGER	-17.3	-9.3	0.0	16.7	4.4	56.4	0.055	0.
30	STINGER	-23.5	-11.7	0.0	17.4	-8.2	54.4	0.062	0.
32	STINGER	-29.7	-14.2	0.1	9.4	-5.4	30.3	0.043	0.
34	STINGER	-35.8	-16.9	0.2	0.0	0.0	8.4	0.056	0.
46	SAGEBND	-162.8	-51.0	0.7	0.0	0.0	23.5	0.033	0.
50	SEABED	-210.7	-53.0	0.0	8.0	-3.9	9.3	0.046	0.

SOLUTION SUMMARY

NODE NO.	PIPE SECTION	X COORD (M)	Y COORD (M)	Z COORD (M)	SUPPORT VERT (KN)	REACT HORIZ (KN)	TOTAL MOMENT (KN-M)	TOTAL STRAIN (PCT)	PCT ALL (%)
----------	--------------	--------------	--------------	--------------	--------------------	-------------------	---------------------	---------------------	-------------

1	TENSIONR	77.8	6.2	0.0	-2.6	-0.1	0.0	0.018	0.
3	LAYBARGE	71.5	6.2	0.0	23.6	-0.1	47.0	0.045	0.
5	LAYBARGE	65.4	6.0	0.0	10.2	0.0	33.9	0.059	0.
7	LAYBARGE	59.9	5.7	0.0	14.7	0.0	38.3	0.034	0.
9	LAYBARGE	53.3	5.3	0.0	13.2	0.0	36.9	0.052	0.
11	LAYBARGE	47.3	4.7	0.0	17.4	0.0	42.1	0.069	0.
13	LAYBARGE	38.2	3.7	0.0	21.7	-0.1	47.6	0.045	0.
15	LAYBARGE	29.3	2.4	0.0	17.1	0.1	41.7	0.058	0.
17	LAYBARGE	23.1	1.3	0.0	13.9	-0.1	37.6	0.043	0.
19	LAYBARGE	17.2	0.2	0.0	8.0	-0.1	32.2	0.076	0.
21	LAYBARGE	10.6	-1.2	0.0	22.4	-1.6	56.6	0.083	0.
24	STINGER	-4.6	-5.1	0.0	22.0	-1.7	56.4	0.055	0.
26	STINGER	-11.0	-7.0	0.0	6.3	-0.5	31.6	0.055	0.
28	STINGER	-17.4	-9.0	0.0	11.6	-1.1	37.3	0.062	0.
30	STINGER	-23.7	-11.2	0.0	12.5	-1.5	38.3	0.063	0.
32	STINGER	-29.9	-13.5	0.0	10.4	3.0	36.0	0.070	0.
34	STINGER	-36.1	-15.9	0.0	18.5	-10.7	49.9	0.067	0.
46	SAGEBND	-162.9	-50.7	0.7	0.0	0.0	23.4	0.043	0.
50	SEABED	-210.9	-53.0	0.1	7.1	-3.9	9.7	0.047	0.

SOLUTION SUMMARY

NODE NO.	PIPE SECTION	X COORD (M)	Y COORD (M)	Z COORD (M)	SUPPORT VERT (KN)	REACT HORIZ (KN)	TOTAL MOMENT (KN-M)	TOTAL STRAIN (PCT)	PCT ALL (%)
----------	--------------	--------------	--------------	--------------	--------------------	-------------------	---------------------	---------------------	-------------

1	TENSIONR	77.8	6.2	0.0	-2.6	-0.1	0.0	0.018	0.
3	LAYBARGE	71.5	6.2	0.0	23.7	0.1	47.0	0.035	0.
5	LAYBARGE	65.4	6.0	0.0	10.2	0.0	33.9	0.049	0.
7	LAYBARGE	59.9	5.7	0.0	14.7	0.0	38.3	0.034	0.
9	LAYBARGE	53.3	5.3	0.0	13.2	0.0	36.9	0.052	0.

11	LAYBARGE	47.3	4.7	0.0	17.4	0.0	42.1	0.069	0.
13	LAYBARGE	38.2	3.7	0.0	21.8	-0.1	47.7	0.035	0.
15	LAYBARGE	29.3	2.4	0.0	17.1	0.1	41.7	0.048	0.
17	LAYBARGE	23.1	1.3	0.0	14.0	-0.1	37.6	0.063	0.
19	LAYBARGE	17.2	0.2	0.0	7.8	-0.1	31.9	0.046	0.
21	LAYBARGE	10.6	-1.2	0.0	23.0	-1.7	57.6	0.057	0.
24	STINGER	-4.6	-5.1	0.0	19.5	-1.7	47.6	0.065	0.
26	STINGER	-11.0	-6.9	0.0	4.6	-0.3	23.0	0.055	0.
28	STINGER	-17.4	-8.9	0.0	10.7	-2.2	29.6	0.053	0.
30	STINGER	-23.7	-10.9	0.0	9.6	2.9	27.7	0.040	0.
32	STINGER	-30.0	-13.1	0.0	1.5	0.9	23.5	0.055	0.
34	STINGER	-36.3	-15.4	0.0	32.6	-13.5	83.6	0.103	0.
47	SAGEEND	-175.0	-51.6	0.6	0.0	0.0	23.7	0.053	0.
50	SEABED	-210.9	-53.0	0.1	6.3	-3.6	10.5	0.048	0.

SOLUTION SUMMARY

NODE NO.	PIPE SECTION	X COORD (M)	Y COORD (M)	Z COORD (M)	SUPPORT VERT (KN)	REACT HORIZ (KN)	TOTAL MOMENT (KN-M)	TOTAL STRAIN (PCT)	PCT ALL (%)
1	TENSIONR	77.8	6.2	0.0	-2.4	-0.1	0.0	0.024	0.
3	LAYBARGE	71.5	6.2	0.0	26.0	0.1	48.2	0.062	0.
5	LAYBARGE	65.4	6.0	0.0	12.1	0.0	34.8	0.056	0.
7	LAYBARGE	59.9	5.7	0.0	16.8	0.0	39.4	0.041	0.
9	LAYBARGE	53.3	5.3	0.0	15.2	0.0	37.9	0.030	0.
11	LAYBARGE	47.3	4.7	0.0	20.0	0.1	43.8	0.047	0.
13	LAYBARGE	38.2	3.7	0.0	25.0	0.1	50.2	0.074	0.
15	LAYBARGE	29.3	2.4	0.0	19.7	0.1	43.4	0.056	0.
17	LAYBARGE	23.1	1.3	0.0	15.9	-0.1	38.5	0.060	0.
19	LAYBARGE	17.2	0.2	0.0	9.8	-0.1	33.0	0.073	0.
21	LAYBARGE	10.6	-1.2	0.0	25.8	-1.6	60.0	0.066	0.
24	STINGER	-4.6	-5.1	0.0	33.1	-2.8	80.4	0.110	0.
26	STINGER	-11.0	-7.1	0.0	12.7	5.5	50.7	0.074	0.
28	STINGER	-17.3	-9.3	0.0	22.8	-12.5	59.0	0.063	0.
30	STINGER	-23.5	-11.6	0.1	5.0	-2.9	17.4	0.054	0.
32	STINGER	-29.8	-14.0	0.2	0.0	0.0	9.4	0.063	0.
34	STINGER	-36.0	-16.4	0.3	0.0	0.0	13.5	0.079	0.
44	SAGEEND	-140.0	-44.8	1.1	0.0	0.0	16.6	0.062	0.
52	SEABED	-235.5	-53.0	0.1	5.1	-3.0	9.0	0.032	0.

SOLUTION SUMMARY

NODE NO.	PIPE SECTION	X COORD (M)	Y COORD (M)	Z COORD (M)	SUPPORT VERT (KN)	REACT HORIZ (KN)	TOTAL MOMENT (KN-M)	TOTAL STRAIN (PCT)	PCT ALL (%)
1	TENSIONR	77.8	6.2	0.0	-2.4	-0.1	0.0	0.034	0.
3	LAYBARGE	71.5	6.2	0.0	25.9	0.1	48.2	0.042	0.
5	LAYBARGE	65.4	6.0	0.0	12.1	0.0	34.8	0.056	0.

7	LAYBARGE	59.9	5.7	0.0	16.8	0.0	39.4	0.061	0.
9	LAYBARGE	53.3	5.3	0.0	15.2	0.0	37.9	0.049	0.
11	LAYBARGE	47.3	4.7	0.0	20.0	0.1	43.8	0.067	0.
13	LAYBARGE	38.2	3.7	0.0	25.0	0.1	50.1	0.084	0.
15	LAYBARGE	29.3	2.4	0.0	19.7	0.1	43.4	0.066	0.
17	LAYBARGE	23.1	1.3	0.0	16.0	-0.1	38.6	0.040	0.
19	LAYBARGE	17.2	0.2	0.0	9.5	-0.1	32.6	0.053	0.
21	LAYBARGE	10.6	-1.2	0.0	26.8	-1.7	61.3	0.093	0.
24	STINGER	-4.6	-5.1	0.0	26.4	-1.5	61.1	0.092	0.
26	STINGER	-11.0	-7.0	0.0	8.0	-1.4	32.4	0.042	0.
28	STINGER	-17.4	-9.0	0.0	15.6	3.2	40.5	0.052	0.
30	STINGER	-23.7	-11.2	0.0	13.9	-7.1	36.8	0.066	0.
32	STINGER	-29.9	-13.5	0.1	11.0	-6.4	27.3	0.076	0.
34	STINGER	-36.2	-15.8	0.2	0.0	0.0	7.8	0.041	0.
42	SAGBEND	-116.6	-39.8	1.0	0.0	0.0	16.4	0.052	0.
52	SEABED	-235.6	-53.0	0.1	4.0	-2.5	10.4	0.064	0.

SOLUTION SUMMARY

NODE NO.	PIPE SECTION	X COORD (M)	Y COORD (M)	Z COORD (M)	SUPPORT VERT (KN)	REACT HORIZ (KN)	TOTAL MOMENT (KN-M)	TOTAL STRAIN (PCT)	PCT ALL (%)
----------	--------------	------------------	------------------	------------------	------------------------	-----------------------	--------------------------	-------------------------	------------------

1	TENSIONR	77.8	6.2	0.0	-2.4	-0.1	0.0	0.024	0.
3	LAYBARGE	71.5	6.2	0.0	25.9	-0.1	48.2	0.042	0.
5	LAYBARGE	65.4	6.0	0.0	12.1	0.0	34.8	0.066	0.
7	LAYBARGE	59.9	5.7	0.0	16.8	0.0	39.4	0.051	0.
9	LAYBARGE	53.3	5.3	0.0	15.2	0.0	37.9	0.079	0.
11	LAYBARGE	47.3	4.7	0.0	20.0	-0.1	43.8	0.057	0.
13	LAYBARGE	38.2	3.7	0.0	25.0	-0.1	50.1	0.034	0.
15	LAYBARGE	29.3	2.4	0.0	19.7	0.1	43.4	0.056	0.
17	LAYBARGE	23.1	1.3	0.0	16.0	-0.1	38.6	0.040	0.
19	LAYBARGE	17.2	0.2	0.0	9.3	-0.1	32.5	0.073	0.
21	LAYBARGE	10.6	-1.2	0.0	27.3	-1.6	61.9	0.095	0.
24	STINGER	-4.6	-5.1	0.0	23.2	-1.7	51.5	0.055	0.
26	STINGER	-11.0	-6.9	0.0	5.7	-0.7	23.4	0.061	0.
28	STINGER	-17.4	-8.9	0.0	12.6	-1.6	30.7	0.060	0.
30	STINGER	-23.7	-10.9	0.0	11.7	2.5	29.9	0.059	0.
32	STINGER	-30.0	-13.1	0.0	10.9	-5.7	27.6	0.065	0.
34	STINGER	-36.3	-15.3	0.1	11.5	-6.6	26.6	0.045	0.
43	SAGBEND	-128.4	-42.0	1.0	0.0	0.0	16.5	0.052	0.
52	SEABED	-235.7	-53.0	0.1	3.1	-1.8	11.9	0.065	0.

SOLUTION SUMMARY

NODE NO.	PIPE SECTION	X COORD (M)	Y COORD (M)	Z COORD (M)	SUPPORT VERT (KN)	REACT HORIZ (KN)	TOTAL MOMENT (KN-M)	TOTAL STRAIN (PCT)	PCT ALL (%)
----------	--------------	------------------	------------------	------------------	------------------------	-----------------------	--------------------------	-------------------------	------------------

1	TENSIONR	77.8	6.2	0.0	-2.6	-0.1	0.0	0.018	0.
---	----------	------	-----	-----	------	------	-----	-------	----

3	LAYBARGE	71.5	6.2	0.0	23.6	0.1	47.0	0.035	0.
5	LAYBARGE	65.4	6.0	0.0	10.2	0.0	33.9	0.069	0.
7	LAYBARGE	59.9	5.7	0.0	14.7	0.0	38.3	0.094	0.
9	LAYBARGE	53.3	5.3	0.0	13.2	0.0	36.9	0.072	0.
11	LAYBARGE	47.3	4.7	0.0	17.4	0.0	42.1	0.088	0.
13	LAYBARGE	38.2	3.7	0.0	21.7	-0.1	47.6	0.055	0.
15	LAYBARGE	29.3	2.4	0.0	17.1	0.1	41.7	0.088	0.
17	LAYBARGE	23.1	1.3	0.0	13.8	-0.1	37.4	0.063	0.
19	LAYBARGE	17.2	0.2	0.0	8.5	-0.1	32.7	0.067	0.
21	LAYBARGE	10.6	-1.2	0.0	21.1	-1.7	54.7	0.043	0.
24	STINGER	-4.6	-5.1	0.0	27.1	-1.7	74.4	0.102	0.
26	STINGER	-11.0	-7.1	0.0	9.0	-1.1	48.2	0.055	0.
28	STINGER	-17.3	-9.3	0.0	16.9	2.3	56.6	0.065	0.
30	STINGER	-23.5	-11.7	0.0	16.1	-3.3	54.3	0.082	0.
32	STINGER	-29.7	-14.3	0.0	16.3	-9.3	49.1	0.046	0.
34	STINGER	-35.8	-17.0	0.1	0.0	0.0	6.2	0.064	0.
47	SAGEBND	-174.1	-54.5	0.6	0.0	0.0	23.8	0.044	0.
50	SEAFED	-210.0	-56.0	0.1	4.9	-2.9	12.5	0.030	0.

SOLUTION SUMMARY

NODE NO.	PIPE SECTION	X COORD (M)	Y COORD (M)	Z COORD (M)	SUPPORT VERT (KN)	REACT HORIZ (KN)	TOTAL MOMENT (KN-M)	TOTAL STRAIN (PCT)	PCT ALL (%)
----------	--------------	-----------------	-----------------	-----------------	-----------------------	----------------------	------------------------	------------------------	----------------

1	TENSIONR	77.8	6.2	0.0	-2.6	-0.1	0.0	0.018	0.
3	LAYBARGE	71.5	6.2	0.0	23.7	0.1	47.0	0.045	0.
5	LAYBARGE	65.4	6.0	0.0	10.2	0.0	33.9	0.079	0.
7	LAYBARGE	59.9	5.7	0.0	14.7	0.0	38.3	0.054	0.
9	LAYBARGE	53.3	5.3	0.0	13.2	0.0	36.9	0.062	0.
11	LAYBARGE	47.3	4.7	0.0	17.4	0.0	42.1	0.039	0.
13	LAYBARGE	38.2	3.7	0.0	21.7	-0.1	47.6	0.065	0.
15	LAYBARGE	29.3	2.4	0.0	17.1	0.1	41.7	0.048	0.
17	LAYBARGE	23.1	1.3	0.0	13.9	-0.1	37.6	0.063	0.
19	LAYBARGE	17.2	0.2	0.0	8.1	-0.1	32.2	0.036	0.
21	LAYBARGE	10.6	-1.2	0.0	22.4	-1.7	56.6	0.046	0.
24	STINGER	-4.6	-5.1	0.0	22.0	-1.7	56.5	0.085	0.
26	STINGER	-11.0	-7.0	0.0	6.1	-0.5	31.4	0.065	0.
28	STINGER	-17.4	-9.0	0.0	12.0	-1.1	37.7	0.063	0.
30	STINGER	-23.7	-11.2	0.0	11.1	-1.8	36.9	0.041	0.
32	STINGER	-29.9	-13.5	0.0	7.3	4.3	34.3	0.038	0.
34	STINGER	-36.1	-15.9	0.0	24.6	-14.1	68.1	0.124	0.
47	SAGEBND	-174.3	-54.2	0.6	0.0	0.0	23.8	0.044	0.
50	SEAFED	-210.2	-56.0	0.1	3.1	-1.8	16.2	0.034	0.

SOLUTION SUMMARY

NODE NO.	PIPE SECTION	X COORD (M)	Y COORD (M)	Z COORD (M)	SUPPORT VERT (KN)	REACT HORIZ (KN)	TOTAL MOMENT (KN-M)	TOTAL STRAIN (PCT)	PCT ALL (%)
----------	--------------	-----------------	-----------------	-----------------	-----------------------	----------------------	------------------------	------------------------	----------------

1	TENSIONR	77.8	6.2	0.0	-2.6	-0.1	0.0	0.018	0.
3	LAYBARGE	71.5	6.2	0.0	23.7	0.1	47.0	0.045	0.
5	LAYBARGE	65.4	6.0	0.0	10.2	0.0	33.9	0.069	0.
7	LAYBARGE	59.9	5.7	0.0	14.7	0.0	38.3	0.054	0.
9	LAYBARGE	53.3	5.3	0.0	13.2	0.0	36.9	0.042	0.
11	LAYBARGE	47.3	4.7	0.0	17.4	0.0	42.1	0.069	0.
13	LAYBARGE	38.2	3.7	0.0	21.7	-0.1	47.6	0.055	0.
15	LAYBARGE	29.3	2.4	0.0	17.1	0.1	41.7	0.068	0.
17	LAYBARGE	23.1	1.3	0.0	14.0	-0.1	37.6	0.083	0.
19	LAYBARGE	17.2	0.2	0.0	7.8	-0.1	31.9	0.076	0.
21	LAYBARGE	10.6	-1.2	0.0	23.0	-1.6	57.5	0.037	0.
24	STINGER	-4.6	-5.1	0.0	19.6	-1.7	47.6	0.075	0.
26	STINGER	-11.0	-6.9	0.0	4.4	-0.2	22.8	0.045	0.
28	STINGER	-17.4	-8.9	0.0	11.4	-2.4	30.3	0.054	0.
30	STINGER	-23.7	-10.9	0.0	7.1	3.6	23.8	0.046	0.
32	STINGER	-30.1	-13.1	0.0	0.0	0.0	24.9	0.047	0.
34	STINGER	-36.3	-15.4	0.0	39.7	-12.8	100.4	0.093	0.
47	SAGEBEND	-174.3	-54.0	0.6	0.0	0.0	23.7	0.044	0.
51	SEAFED	-222.3	-56.0	0.0	8.2	-3.7	8.8	0.055	0.

OUTPUT ANALISA DINAMIS HEADING 135°

OFFPIPE - OFFSHORE PIPELINE ANALYSIS SYSTEM - VERSION 2.05 AC DATE - 5/ 6/2020 TIME - 21: 6:22
PAGE 106
PROJECT - TUGAS AKHIR JOB NO. - ANALISIS
DINAMIS
USER ID - IDA BAGUS HUNDHARA SAKYANARY LICENSED TO: RICKY TAWKAL CASE
1

NODE	PIPE	X	Y	Z	HORIZ	VERT	PIPE	TENSILE	HOOP	BENDING	SIRESS
TOTAL	PERONT	COORD	COORD	COORD	ANGLE	ANGLE	LENGIH	SIRESS	SIRESS	VERT	HORIZ
NO.	SECTION										
SIRESS	YIELD										

(MEA)	(PCT)	(M)	(M)	(M)	(DEG)	(DEG)	(M)	(MEA)	(MEA)	(MEA)	(MEA)
1	TENSIONR	77.79	6.21	0.00	0.000	0.314	0.00	48.75	0.00	0.00	0.00
48.75	13.54										
3	LAYBARGE	71.49	6.16	0.00	0.000	0.955	6.30	48.73	0.00	-106.60	0.00
139.35	38.71										
5	LAYBARGE	65.38	5.98	0.00	0.000	2.220	12.42	48.71	0.00	-76.71	0.00
113.91	31.64										
7	LAYBARGE	59.91	5.72	0.00	0.000	3.295	17.89	48.67	0.00	-87.57	0.00
123.10	34.20										
9	LAYBARGE	53.32	5.27	0.00	0.000	4.484	24.49	48.60	0.00	-84.16	0.00
120.14	33.37										
11	LAYBARGE	47.32	4.74	0.00	0.000	5.779	30.51	48.51	0.00	-103.48	0.00
136.47	37.91										
13	LAYBARGE	38.21	3.69	0.00	0.000	7.419	39.68	48.34	0.00	-124.51	0.00
154.17	42.83										
15	LAYBARGE	29.27	2.39	0.00	0.000	9.063	48.72	48.14	0.00	-102.45	0.02
135.22	37.56										
17	LAYBARGE	23.13	1.33	0.00	0.000	10.378	54.95	47.98	0.00	-85.49	-0.08
120.64	33.51										
19	LAYBARGE	17.18	0.19	0.00	0.002	11.410	61.01	47.80	0.00	-68.25	0.37
105.79	29.39										
21	LAYBARGE	10.63	-1.22	0.00	-0.022	13.185	67.72	47.59	-0.08	-159.14	-5.46
182.97	50.82										
24	STINGER	-4.64	-5.13	0.00	0.026	15.809	83.47	47.07	-0.34	-201.98	-4.85
218.96	60.82										
26	STINGER	-11.01	-7.10	0.00	-0.021	18.256	90.14	46.85	-0.47	-101.62	-3.14
133.50	37.08										
28	STINGER	-17.30	-9.29	0.00	0.071	20.058	96.81	46.56	-0.62	-125.97	10.96
154.31	42.86										
30	STINGER	-23.53	-11.68	0.00	-0.320	21.937	103.47	46.25	-0.78	-110.00	-57.34
151.34	42.04										
32	STINGER	-29.68	-14.24	0.08	-0.970	22.819	110.14	45.94	-0.95	-12.59	-17.77
64.60	17.94										
34	STINGER	-35.83	-16.81	0.19	-1.093	22.538	116.81	45.61	-1.12	25.76	1.05
67.59	18.77										
36	SAGEEND	-46.96	-21.30	0.39	-0.951	21.326	128.81	45.03	-1.42	32.86	4.11
73.54	20.43										
37	SAGEEND	-58.19	-25.54	0.56	-0.776	20.018	140.81	44.48	-1.70	33.81	4.16
74.02	20.56										
38	SAGEEND	-69.51	-29.51	0.70	-0.606	18.683	152.81	43.97	-1.97	34.37	4.01
74.19	20.61										
39	SAGEEND	-80.92	-33.22	0.80	-0.445	17.327	164.81	43.49	-2.22	34.86	3.84
74.34	20.65										
40	SAGEEND	-92.42	-36.66	0.88	-0.290	15.951	176.81	43.04	-2.44	35.36	3.68
74.47	20.69										
41	SAGEEND	-103.99	-39.82	0.92	-0.144	14.553	188.81	42.64	-2.65	35.88	3.51
74.59	20.72										
42	SAGEEND	-115.64	-42.69	0.93	-0.007	13.137	200.81	42.27	-2.85	36.36	3.30
74.69	20.75										
43	SAGEEND	-127.36	-45.27	0.92	0.121	11.706	212.81	41.93	-3.02	36.77	3.07
74.78	20.77										
44	SAGEEND	-139.14	-47.55	0.89	0.238	10.259	224.81	41.64	-3.17	37.10	2.82
74.84	20.79										
45	SAGEEND	-150.98	-49.54	0.83	0.345	8.800	236.81	41.38	-3.30	37.37	2.57
74.88	20.80										
46	SAGEEND	-162.86	-51.22	0.74	0.440	7.329	248.81	41.17	-3.41	37.62	2.33
74.90	20.80										
47	SAGEEND	-174.78	-52.60	0.64	0.528	5.847	260.81	40.99	-3.51	37.85	2.17
74.89	20.80										
48	SAGEEND	-186.73	-53.67	0.52	0.610	4.358	272.81	40.85	-3.58	38.07	2.11
74.85	20.79										
49	SAGEEND	-198.70	-54.42	0.39	0.691	2.864	284.81	40.76	-3.63	38.13	2.07
74.72	20.76										
50	SAGEEND	-210.69	-54.87	0.24	0.762	1.381	296.81	40.70	-3.65	36.79	1.24
73.43	20.40										

51	SEABED	-222.69	-55.02	0.08	0.661	0.175	308.81	40.69	-3.66	16.89	-11.51
59.11	16.42										
52	SEABED	-234.69	-55.03	0.00	0.082	-0.002	320.81	40.68	-3.66	0.42	-8.35
49.46	13.74										
53	SEABED	-246.69	-55.02	0.00	-0.001	0.000	332.81	40.68	-3.66	-0.04	-0.16
42.75	11.87										
54	SEABED	-258.69	-55.02	0.00	0.000	0.000	344.81	40.68	-3.66	0.00	0.02
42.65	11.85										
55	SEABED	-270.69	-55.02	0.00	0.000	0.000	356.81	40.68	-3.66	0.00	0.00
42.64	11.84										
56	SEABED	-282.69	-55.02	0.00	0.000	0.000	368.81	40.68	-3.66	0.00	0.00
42.64	11.84										
57	SEABED	-294.69	-55.02	0.00	0.000	0.000	380.81	40.68	-3.66	0.00	0.00
42.64	11.84										
58	SEABED	-306.69	-55.02	0.00	0.000	0.000	392.81	40.68	-3.66	0.00	0.00
42.64	11.84										

OFFPIPE - OFFSHORE PIPELINE ANALYSIS SYSTEM - VERSION 2.05 AC DATE - 5/ 6/2020 TIME - 21: 6:22
PAGE 106
PROJECT - TUGAS AKHIR JOB NO. - ANALISIS
DINAMIS
USER ID - IDA BAGUS PUNDHARA SARZANARY LICENSED TO: RICKY TAWEKAL CASE
2

NODE	PIPE	X	Y	Z	HORIZ	VERT	PIPE	TENSILE	HOOP	BENDING	SIRESS
TOTAL	PERCENT	COORD	COORD	COORD	ANGLE	ANGLE	LENGIH	SIRESS	SIRESS	VERT	HORIZ
NO.	SECTION	(M)	(M)	(M)	(DEG)	(DEG)	(M)	(MPA)	(MPA)	(MPA)	(MPA)
SIRESS	YIELD										
(MPA)	(PCT)										
1	TENSIONR	77.79	6.21	0.00	0.000	0.315	0.00	48.75	0.00	0.00	0.00
48.75	13.54										
3	LAYARGE	71.49	6.16	0.00	0.000	0.956	6.30	48.73	0.00	-106.60	0.00
139.34	38.71										
5	LAYARGE	65.38	5.99	0.00	0.000	2.222	12.42	48.71	0.00	-76.70	0.00
113.91	31.64										
7	LAYARGE	59.91	5.72	0.00	0.000	3.296	17.89	48.67	0.00	-87.57	0.00
123.10	34.19										
9	LAYARGE	53.32	5.28	0.00	0.000	4.485	24.49	48.60	0.00	-84.16	0.00
120.13	33.37										
11	LAYARGE	47.32	4.74	0.00	0.000	5.780	30.51	48.51	0.00	-103.47	0.00
136.46	37.91										

13	LAYARGE	38.22	3.69	0.00	0.000	7.420	39.68	48.34	0.00	-124.50	0.00
154.17	42.82										
15	LAYARGE	29.27	2.39	0.00	0.000	9.064	48.72	48.14	0.00	-102.45	0.02
135.22	37.56										
17	LAYARGE	23.13	1.34	0.00	0.000	10.380	54.95	47.97	0.00	-85.49	-0.08
120.64	33.51										
19	LAYARGE	17.18	0.19	0.00	0.002	11.412	61.01	47.80	0.00	-68.24	0.37
105.79	29.38										
21	LAYARGE	10.63	-1.22	0.00	-0.021	13.187	67.72	47.59	-0.08	-159.20	-5.42
183.01	50.84										
24	STINGER	-4.64	-5.13	0.00	0.023	15.808	83.47	47.07	-0.34	-201.85	-5.24
218.86	60.80										
26	STINGER	-11.00	-7.10	0.00	-0.009	18.262	90.14	46.85	-0.47	-102.52	-1.44
134.19	37.27										
28	STINGER	-17.30	-9.29	0.00	0.020	20.037	96.81	46.56	-0.62	-122.10	3.10
150.66	41.85										
30	STINGER	-23.53	-11.67	0.01	-0.490	21.822	103.47	46.25	-0.78	-105.59	-61.46
150.35	41.76										
32	STINGER	-29.70	-14.21	0.11	-1.084	22.475	110.14	45.94	-0.95	10.12	-6.54
56.20	15.61										
34	STINGER	-35.86	-16.73	0.23	-1.097	21.992	116.81	45.61	-1.12	28.93	2.61
70.55	19.60										
36	SAGEEND	-47.04	-21.11	0.43	-0.935	20.740	128.81	45.05	-1.41	33.13	4.24
73.88	20.52										
37	SAGEEND	-58.31	-25.23	0.59	-0.759	19.424	140.81	44.52	-1.68	33.87	4.22
74.19	20.61										
38	SAGEEND	-69.67	-29.08	0.73	-0.589	18.084	152.81	44.02	-1.94	34.41	4.08
74.32	20.64										
39	SAGEEND	-81.12	-32.67	0.83	-0.427	16.724	164.81	43.56	-2.18	34.94	3.91
74.45	20.68										
40	SAGEEND	-92.65	-35.99	0.90	-0.272	15.343	176.81	43.13	-2.40	35.42	3.79
74.57	20.71										
41	SAGEEND	-104.26	-39.02	0.94	-0.124	13.945	188.81	42.74	-2.60	35.90	3.65
74.69	20.75										
42	SAGEEND	-115.94	-41.77	0.95	0.015	12.530	200.81	42.38	-2.79	36.35	3.49
74.80	20.78										
43	SAGEEND	-127.69	-44.23	0.93	0.147	11.098	212.81	42.07	-2.95	36.74	3.30
74.88	20.80										
44	SAGEEND	-139.49	-46.39	0.89	0.268	9.652	224.81	41.79	-3.09	37.04	3.12
74.92	20.81										
45	SAGEEND	-151.34	-48.25	0.82	0.380	8.193	236.81	41.55	-3.22	37.34	2.94
74.92	20.81										
46	SAGEEND	-163.24	-49.81	0.73	0.484	6.723	248.81	41.35	-3.32	37.55	2.79
74.92	20.81										
47	SAGEEND	-175.18	-51.06	0.62	0.579	5.246	260.81	41.19	-3.40	37.79	2.69
74.89	20.80										
48	SAGEEND	-187.14	-52.00	0.49	0.668	3.761	272.81	41.07	-3.46	37.97	2.59
74.85	20.79										
49	SAGEEND	-199.12	-52.63	0.34	0.750	2.274	284.81	40.99	-3.51	37.84	2.41
74.59	20.72										
50	SAGEEND	-211.11	-52.96	0.18	0.799	0.827	296.81	40.95	-3.53	34.18	-1.79
71.40	19.83										
51	SEABED	-223.11	-53.02	0.04	0.452	0.032	308.81	40.94	-3.53	5.44	-16.59
57.07	15.85										
52	SEABED	-235.11	-53.03	0.00	0.018	-0.002	320.81	40.94	-3.53	-0.07	-3.37
45.45	12.63										
53	SEABED	-247.11	-53.02	0.00	-0.001	0.000	332.81	40.94	-3.53	-0.01	0.05
42.85	11.90										
54	SEABED	-259.11	-53.02	0.00	0.000	0.000	344.81	40.94	-3.53	0.00	0.01
42.82	11.90										
55	SEABED	-271.11	-53.02	0.00	0.000	0.000	356.81	40.94	-3.53	0.00	0.00
42.82	11.89										
56	SEABED	-283.11	-53.02	0.00	0.000	0.000	368.81	40.94	-3.53	0.00	0.00
42.82	11.89										
57	SEABED	-295.11	-53.02	0.00	0.000	0.000	380.81	40.94	-3.53	0.00	0.00
42.82	11.89										
58	SEABED	-307.11	-53.02	0.00	0.000	0.000	392.81	40.94	-3.53	0.00	0.00
42.82	11.89										

OFFPIPE - OFFSHORE PIPELINE ANALYSIS SYSTEM - VERSION 2.05 AC DATE - 5/ 6/2020 TIME - 21: 6:22
PAGE 106
PROJECT - TUGAS AKHIR JOB NO. - ANALISIS
DINAMIS
USER ID - IDA BAGUS PUNDHARA SAKYANARY LICENSED TO: RICKY TAMEKAL CASE
3

NODE TOTAL NO. STRESS (MPA)	PIPE PERCENT SECTION YIELD (PCT)	X COORD (M)	Y COORD (M)	Z COORD (M)	HORIZ ANGLE (DEG)	VERT ANGLE (DEG)	PIPE LENGIH (M)	TENSILE STRESS (MPA)	HOOP STRESS (MPA)	BENDING STRESSES VERT (MPA)	HORIZ (MPA)
1	TENSIONR	77.79	6.21	0.00	0.000	0.315	0.00	48.70	0.00	0.00	0.00
48.70	13.53										
3	LAYBARGE	71.49	6.16	0.00	0.000	0.956	6.30	48.69	0.00	-106.59	0.00
139.29	38.69										
5	LAYBARGE	65.37	5.98	0.00	0.000	2.222	12.42	48.66	0.00	-76.70	0.00
113.86	31.63										
7	LAYBARGE	59.91	5.72	0.00	0.000	3.296	17.89	48.62	0.00	-87.56	0.00
123.04	34.18										
9	LAYBARGE	53.32	5.27	0.00	0.000	4.485	24.49	48.55	0.00	-84.15	0.00
120.08	33.35										
11	LAYBARGE	47.32	4.74	0.00	0.000	5.780	30.51	48.46	0.00	-103.45	0.00
136.39	37.89										
13	LAYBARGE	38.21	3.69	0.00	0.000	7.420	39.68	48.29	0.00	-124.47	0.00
154.09	42.80										
15	LAYBARGE	29.27	2.39	0.00	0.000	9.064	48.72	48.09	0.00	-102.42	0.02
135.14	37.54										
17	LAYBARGE	23.13	1.33	0.00	0.000	10.380	54.95	47.93	0.00	-85.48	-0.08
120.58	33.50										
19	LAYBARGE	17.18	0.19	0.00	0.002	11.411	61.01	47.75	0.00	-68.20	0.36
105.70	29.36										
21	LAYBARGE	10.63	-1.23	0.00	-0.021	13.189	67.72	47.54	-0.08	-159.30	-5.40
183.02	50.84										
24	STINGER	-4.62	-5.11	0.00	0.022	15.377	83.45	47.04	-0.34	-158.71	-5.38
182.16	50.60										
26	STINGER	-11.01	-6.99	0.00	-0.004	17.153	90.12	46.82	-0.47	-66.48	-0.28
103.55	28.76										
28	STINGER	-17.37	-9.02	0.00	-0.004	18.311	96.78	46.56	-0.60	-86.35	-2.35
120.26	33.40										

30	STINGER	-23.67	-11.19	0.00	0.021	19.623	103.45	46.28	-0.75	-84.17	2.87
118.20	32.83										
32	STINGER	-29.93	-13.49	0.00	-0.096	20.828	110.12	45.98	-0.90	-73.66	-19.52
110.73	30.76										
34	STINGER	-36.14	-15.92	0.03	-0.627	21.816	116.79	45.67	-1.06	-61.70	-43.72
110.22	30.62										
36	SAGEEND	-47.27	-20.40	0.22	-1.000	21.541	128.79	45.10	-1.36	28.17	1.78
69.44	19.29										
37	SAGEEND	-58.47	-24.69	0.40	-0.852	20.289	140.79	44.55	-1.65	33.46	4.06
73.78	20.50										
38	SAGEEND	-69.78	-28.72	0.55	-0.682	18.958	152.79	44.03	-1.91	34.25	4.05
74.16	20.60										
39	SAGEEND	-81.17	-32.48	0.67	-0.518	17.606	164.79	43.54	-2.17	34.79	3.88
74.32	20.64										
40	SAGEEND	-92.65	-35.97	0.76	-0.363	16.234	176.79	43.09	-2.40	35.29	3.72
74.45	20.68										
41	SAGEEND	-104.21	-39.19	0.82	-0.215	14.841	188.79	42.68	-2.61	35.79	3.54
74.55	20.71										
42	SAGEEND	-115.85	-42.12	0.85	-0.076	13.429	200.79	42.30	-2.81	36.28	3.35
74.65	20.74										
43	SAGEEND	-127.55	-44.76	0.85	0.054	12.002	212.79	41.96	-2.98	36.73	3.12
74.77	20.77										
44	SAGEEND	-139.32	-47.11	0.83	0.173	10.560	224.79	41.66	-3.14	37.10	2.87
74.85	20.79										
45	SAGEEND	-151.14	-49.16	0.78	0.282	9.102	236.79	41.39	-3.28	37.37	2.61
74.88	20.80										
46	SAGEEND	-163.01	-50.90	0.71	0.381	7.635	248.79	41.17	-3.39	37.57	2.36
74.87	20.80										
47	SAGEEND	-174.93	-52.34	0.62	0.469	6.155	260.79	40.99	-3.49	37.80	2.17
74.84	20.79										
48	SAGEEND	-186.87	-53.47	0.51	0.552	4.666	272.79	40.84	-3.56	38.01	2.10
74.81	20.78										
49	SAGEEND	-198.84	-54.29	0.39	0.633	3.174	284.79	40.74	-3.62	38.14	2.07
74.73	20.76										
50	SAGEEND	-210.83	-54.80	0.25	0.709	1.683	296.79	40.67	-3.65	37.46	1.62
74.00	20.56										
51	SEAFED	-222.83	-55.01	0.10	0.693	0.340	308.79	40.65	-3.66	25.40	-6.74
64.39	17.89										
52	SEAFED	-234.83	-55.03	0.01	0.141	0.001	320.79	40.64	-3.66	1.24	-11.62
52.29	14.53										
53	SEAFED	-246.83	-55.02	0.00	0.000	-0.001	332.79	40.64	-3.66	-0.06	-0.39
42.92	11.92										
54	SEAFED	-258.83	-55.02	0.00	0.000	0.000	344.79	40.64	-3.66	0.00	0.03
42.62	11.84										
55	SEAFED	-270.83	-55.02	0.00	0.000	0.000	356.79	40.64	-3.66	0.00	0.00
42.60	11.83										
56	SEAFED	-282.83	-55.02	0.00	0.000	0.000	368.79	40.64	-3.66	0.00	0.00
42.60	11.83										
57	SEAFED	-294.83	-55.02	0.00	0.000	0.000	380.79	40.64	-3.66	0.00	0.00
42.60	11.83										
58	SEAFED	-306.83	-55.02	0.00	0.000	0.000	392.79	40.64	-3.66	0.00	0.00
42.60	11.83										

NODE TOTAL NO.	PIPE SECTION YIELD	X COORD (M)	Y COORD (M)	Z COORD (M)	HORIZ ANGLE (DEG)	VERT ANGLE (DEG)	PIPE LENGIH (M)	TENSILE STRESS (MPA)	HOOP STRESS (MPA)	BENDING STRESSES	
										VERT (MPA)	HORIZ (MPA)
1	TENSIONR	77.79	6.21	0.00	0.000	0.315	0.00	48.74	0.00	0.00	0.00
48.74	13.54										
3	LAYBARGE	71.49	6.16	0.00	0.000	0.956	6.30	48.72	0.00	-106.60	0.00
139.33	38.70										
5	LAYBARGE	65.38	5.99	0.00	0.000	2.222	12.42	48.70	0.00	-76.70	0.00
113.90	31.64										
7	LAYBARGE	59.91	5.73	0.00	0.000	3.296	17.89	48.66	0.00	-87.57	0.00
123.09	34.19										
9	LAYBARGE	53.32	5.28	0.00	0.000	4.485	24.49	48.59	0.00	-84.16	0.00
120.12	33.37										
11	LAYBARGE	47.32	4.74	0.00	0.000	5.780	30.51	48.50	0.00	-103.47	0.00
136.45	37.90										
13	LAYBARGE	38.21	3.69	0.00	0.000	7.420	39.68	48.33	0.00	-124.50	0.00
154.16	42.82										
15	LAYBARGE	29.27	2.39	0.00	0.000	9.064	48.72	48.13	0.00	-102.44	0.02
135.20	37.56										
17	LAYBARGE	23.13	1.33	0.00	0.000	10.380	54.95	47.96	0.00	-85.50	-0.08
120.64	33.51										
19	LAYBARGE	17.18	0.19	0.00	0.002	11.411	61.01	47.79	0.00	-68.17	0.36
105.72	29.37										
21	LAYBARGE	10.63	-1.22	0.00	-0.021	13.189	67.72	47.58	-0.08	-159.51	-5.37
183.27	50.91										
24	STINGER	-4.61	-5.09	0.00	0.022	15.163	83.44	47.08	-0.34	-137.32	-5.29
164.05	45.57										
26	STINGER	-11.02	-6.94	0.00	-0.005	16.601	90.11	46.86	-0.46	-48.72	-0.53
88.50	24.58										
28	STINGER	-17.40	-8.88	0.00	0.003	17.443	96.77	46.61	-0.59	-67.37	-1.19
104.18	28.94										
30	STINGER	-23.74	-10.94	0.00	-0.009	18.447	103.44	46.34	-0.73	-67.44	-3.06
104.05	28.90										
32	STINGER	-30.05	-13.10	0.00	0.082	19.263	110.11	46.07	-0.87	-45.66	10.77
86.06	23.91										
34	STINGER	-36.32	-15.36	0.00	-0.382	20.845	116.77	45.75	-1.02	-159.32	-64.19
191.91	53.31										
36	SAGEBND	-47.46	-19.81	0.17	-1.012	21.653	128.77	45.20	-1.32	22.79	0.53
64.86	18.02										
37	SAGEBND	-58.66	-24.12	0.36	-0.879	20.461	140.77	44.64	-1.61	33.11	3.98
73.46	20.41										
38	SAGEBND	-69.94	-28.19	0.52	-0.709	19.138	152.77	44.12	-1.88	34.18	4.04
74.10	20.58										
39	SAGEBND	-81.33	-31.99	0.64	-0.544	17.791	164.77	43.63	-2.13	34.71	3.88
74.25	20.62										
40	SAGEBND	-92.79	-35.52	0.73	-0.388	16.420	176.77	43.17	-2.37	35.21	3.73
74.37	20.66										

41	SAGEEND	-104.34	-38.77	0.80	-0.238	15.029	188.77	42.75	-2.58	35.69	3.56
74.52	20.70										
42	SAGEEND	-115.97	-41.74	0.83	-0.098	13.620	200.77	42.37	-2.78	36.18	3.38
74.64	20.73										
43	SAGEEND	-127.67	-44.42	0.84	0.033	12.194	212.77	42.02	-2.96	36.64	3.16
74.74	20.76										
44	SAGEEND	-139.43	-46.81	0.82	0.154	10.752	224.77	41.72	-3.12	37.01	2.91
74.81	20.78										
45	SAGEEND	-151.24	-48.90	0.77	0.264	9.299	236.77	41.45	-3.26	37.32	2.67
74.86	20.79										
46	SAGEEND	-163.11	-50.68	0.71	0.364	7.831	248.77	41.22	-3.38	37.56	2.42
74.87	20.80										
47	SAGEEND	-175.02	-52.17	0.62	0.454	6.351	260.77	41.03	-3.48	37.78	2.21
74.86	20.79										
48	SAGEEND	-186.96	-53.34	0.52	0.537	4.866	272.77	40.88	-3.55	37.99	2.13
74.82	20.78										
49	SAGEEND	-198.93	-54.20	0.40	0.618	3.374	284.77	40.77	-3.61	38.14	2.11
74.74	20.76										
50	SAGEEND	-210.91	-54.75	0.26	0.695	1.882	296.77	40.70	-3.65	37.72	1.80
74.26	20.63										
51	SAGEEND	-222.91	-54.99	0.11	0.706	0.483	308.77	40.67	-3.66	29.77	-4.71
67.69	18.80										
52	SEALED	-234.91	-55.03	0.01	0.189	0.006	320.77	40.67	-3.66	2.14	-14.11
54.43	15.12										
53	SEALED	-246.91	-55.02	0.00	0.000	-0.001	332.77	40.67	-3.66	-0.08	-0.67
43.10	11.97										
54	SEALED	-258.91	-55.02	0.00	0.000	0.000	344.77	40.67	-3.66	0.00	0.04
42.65	11.85										
55	SEALED	-270.91	-55.02	0.00	0.000	0.000	356.77	40.67	-3.66	0.00	0.00
42.62	11.84										
56	SEALED	-282.91	-55.02	0.00	0.000	0.000	368.77	40.67	-3.66	0.00	0.00
42.62	11.84										
57	SEALED	-294.91	-55.02	0.00	0.000	0.000	380.77	40.67	-3.66	0.00	0.00
42.62	11.84										
58	SEALED	-306.91	-55.02	0.00	0.000	0.000	392.77	40.67	-3.66	0.00	0.00
42.62	11.84										
59	SEALED	-318.91	-55.02	0.00	0.000	0.000	404.77	40.67	-3.66	0.00	0.00
42.62	11.84										

NODE	PIPE	X	Y	Z	HORIZ	VERT	PIPE	TENSILE	HOOP	BENDING	STRESSES
TOTAL	FRONT										
NO.	SECTION	COORD	COORD	COORD	ANGLE	ANGLE	LENGTH	STRESS	STRESS	VERT	HORIZ
STRESS	YIELD	(M)	(M)	(M)	(DEG)	(DEG)	(M)	(MPA)	(MPA)	(MPA)	(MPA)
(MPA)	(PCT)										
1	TENSIONR	77.79	6.21	0.00	0.000	0.318	0.00	56.86	0.00	0.00	0.00
56.86	15.80										
3	LAYARGE	71.49	6.16	0.00	0.000	0.958	6.30	56.84	0.00	-109.02	0.00
149.50	41.53										
5	LAYARGE	65.37	5.99	0.00	0.000	2.220	12.42	56.82	0.00	-78.83	0.00
123.82	34.39										
7	LAYARGE	59.91	5.72	0.00	0.000	3.299	17.89	56.78	0.00	-89.83	0.00
133.13	36.98										
9	LAYARGE	53.32	5.28	0.00	0.000	4.483	24.49	56.71	0.00	-86.48	0.00
130.22	36.17										
11	LAYARGE	47.32	4.74	0.00	0.000	5.787	30.51	56.62	0.00	-107.21	0.00
147.75	41.04										
13	LAYARGE	38.21	3.69	0.00	0.000	7.420	39.68	56.45	0.00	-129.83	0.00
166.81	46.34										
15	LAYARGE	29.27	2.39	0.00	0.000	9.059	48.72	56.25	0.00	-106.23	0.01
146.55	40.71										
17	LAYARGE	23.13	1.34	0.00	0.000	10.380	54.95	56.09	0.00	-87.69	-0.06
130.63	36.28										
19	LAYARGE	17.18	0.19	0.00	0.001	11.410	61.01	55.91	0.00	-69.83	0.28
115.23	32.01										
21	LAYARGE	10.63	-1.22	0.00	-0.020	13.214	67.72	55.70	-0.08	-168.83	-5.15
199.29	55.36										
24	STINGER	-4.64	-5.13	0.00	0.011	15.779	83.47	55.18	-0.34	-212.90	-6.50
236.39	65.66										
26	STINGER	-11.01	-7.10	0.00	0.034	18.271	90.14	54.96	-0.47	-106.57	6.70
145.92	40.53										
28	STINGER	-17.30	-9.29	0.00	-0.180	20.015	96.81	54.67	-0.62	-121.94	-35.09
162.39	45.11										
30	STINGER	-23.54	-11.65	0.05	-0.753	21.285	103.47	54.38	-0.78	-51.65	-35.13
107.75	29.93										
32	STINGER	-29.74	-14.09	0.15	-1.047	21.406	110.14	54.07	-0.94	16.98	-1.83
68.67	19.08										
34	STINGER	-35.96	-16.50	0.27	-1.014	20.904	116.81	53.76	-1.10	26.43	2.99
76.65	21.29										
36	SAGEEND	-47.21	-20.67	0.45	-0.866	19.815	128.81	53.22	-1.38	28.41	3.64
77.99	21.66										
37	SAGEEND	-58.53	-24.63	0.61	-0.717	18.691	140.81	52.71	-1.64	28.86	3.57
78.05	21.68										
38	SAGEEND	-69.94	-28.37	0.74	-0.572	17.553	152.81	52.23	-1.89	29.23	3.45
78.05	21.68										
39	SAGEEND	-81.41	-31.87	0.84	-0.434	16.399	164.81	51.78	-2.13	29.56	3.30
78.04	21.68										
40	SAGEEND	-92.96	-35.14	0.91	-0.302	15.233	176.81	51.36	-2.34	29.91	3.17
78.05	21.68										
41	SAGEEND	-104.57	-38.17	0.96	-0.176	14.054	188.81	50.97	-2.55	30.25	3.05
78.07	21.69										
42	SAGEEND	-116.24	-40.97	0.98	-0.056	12.862	200.81	50.61	-2.73	30.58	2.90
78.08	21.69										
43	SAGEEND	-127.97	-43.51	0.98	0.056	11.658	212.81	50.28	-2.90	30.89	2.73
78.08	21.69										
44	SAGEEND	-139.74	-45.81	0.96	0.161	10.444	224.81	49.98	-3.05	31.14	2.53
78.07	21.69										
45	SAGEEND	-151.57	-47.86	0.92	0.258	9.220	236.81	49.72	-3.19	31.35	2.34
78.05	21.68										
46	SAGEEND	-163.43	-49.66	0.86	0.346	7.986	248.81	49.49	-3.31	31.51	2.14
78.01	21.67										
47	SAGEEND	-175.33	-51.20	0.77	0.427	6.747	260.81	49.29	-3.41	31.67	1.95
77.96	21.66										

48	SAGEEND	-187.26	-52.48	0.68	0.500	5.501	272.81	49.13	-3.50	31.85	1.82
77.89	21.64										
49	SAGEEND	-199.22	-53.50	0.57	0.569	4.250	284.81	49.00	-3.56	31.99	1.77
77.83	21.62										
50	SAGEEND	-211.19	-54.26	0.44	0.638	2.992	296.81	48.90	-3.61	32.08	1.76
77.76	21.60										
51	SAGEEND	-223.18	-54.75	0.30	0.704	1.735	308.81	48.84	-3.65	31.92	1.59
77.47	21.52										
52	SAGEEND	-235.18	-54.99	0.15	0.735	0.530	320.81	48.81	-3.66	27.33	-2.03
73.65	20.46										
53	SEAFED	-247.18	-55.02	0.03	0.327	0.018	332.81	48.81	-3.66	2.99	-14.34
62.94	17.48										
54	SEAFED	-259.18	-55.02	0.00	0.013	-0.001	344.81	48.81	-3.66	-0.02	-1.96
52.33	14.54										
55	SEAFED	-271.18	-55.02	0.00	0.000	0.000	356.81	48.81	-3.66	-0.01	0.01
50.74	14.10										
56	SEAFED	-283.18	-55.02	0.00	0.000	0.000	368.81	48.81	-3.66	0.00	0.00
50.74	14.09										
57	SEAFED	-295.18	-55.02	0.00	0.000	0.000	380.81	48.81	-3.66	0.00	0.00
50.74	14.09										
58	SEAFED	-307.18	-55.02	0.00	0.000	0.000	392.81	48.81	-3.66	0.00	0.00
50.74	14.09										
59	SEAFED	-319.18	-55.02	0.00	0.000	0.000	404.81	48.81	-3.66	0.00	0.00
50.74	14.09										

OFFPIPE - OFFSHORE PIPELINE ANALYSIS SYSTEM - VERSION 2.05 AC DATE - 5/ 6/2020 TIME - 21: 6:22
PAGE 106
PROJECT - TUGAS AKHIR JOB NO. - ANALISIS
DINPMIS
USER ID - IDA EAGUS FUNDHARA SAKYANARY LICENSED TO: RICKY TAMEKAL CASE
6

NODE TOTAL NO. STRESS (MPA)	PIPE PERCENT SECTION YIELD (PCT)	X	Y	Z	HORIZ	VERT	PIPE	TENSILE	HOOP	BENDING STRESSES	
		COORD (M)	COORD (M)	COORD (M)	ANGLE (DEG)	ANGLE (DEG)	LENGIH (M)	STRESS (MPA)	STRESS (MPA)	VERT (MPA)	HORIZ (MPA)
1	TENSIONR	77.79	6.21	0.00	0.000	0.318	0.00	56.95	0.00	0.00	0.00
56.95	15.82										
3	LAYARGE	71.49	6.16	0.00	0.000	0.958	6.30	56.93	0.00	-109.05	0.00
149.62	41.56										

5	LAYARGE	65.37	5.98	0.00	0.000	2.220	12.42	56.91	0.00	-78.85	0.00
123.93	34.43										
7	LAYARGE	59.91	5.72	0.00	0.000	3.298	17.89	56.86	0.00	-89.86	0.00
133.24	37.01										
9	LAYARGE	53.32	5.27	0.00	0.000	4.483	24.49	56.79	0.00	-86.51	0.00
130.33	36.20										
11	LAYARGE	47.32	4.74	0.00	0.000	5.786	30.51	56.70	0.00	-107.26	0.00
147.88	41.08										
13	LAYARGE	38.21	3.69	0.00	0.000	7.420	39.68	56.53	0.00	-129.91	0.00
166.95	46.38										
15	LAYARGE	29.27	2.39	0.00	0.000	9.059	48.72	56.33	0.00	-106.29	0.01
146.68	40.74										
17	LAYARGE	23.13	1.33	0.00	0.000	10.380	54.95	56.17	0.00	-87.68	-0.07
130.70	36.31										
19	LAYARGE	17.18	0.18	0.00	0.001	11.410	61.01	55.99	0.00	-70.00	0.32
115.46	32.07										
21	LAYARGE	10.63	-1.23	0.00	-0.020	13.210	67.72	55.78	-0.08	-168.15	-5.30
198.80	55.22										
24	STINGER	-4.62	-5.11	0.00	0.021	15.356	83.45	55.28	-0.34	-167.63	-5.13
197.99	55.00										
26	STINGER	-11.02	-6.99	0.00	-0.008	17.152	90.12	55.06	-0.47	-67.99	-1.07
113.09	31.42										
28	STINGER	-17.37	-9.02	0.00	0.015	18.324	96.78	54.80	-0.60	-91.54	1.47
132.91	36.92										
30	STINGER	-23.67	-11.19	0.00	-0.067	19.564	103.45	54.52	-0.75	-76.26	-14.69
120.52	33.48										
32	STINGER	-29.93	-13.48	0.03	-0.568	20.622	110.12	54.22	-0.90	-71.61	-47.72
127.65	35.46										
34	STINGER	-36.16	-15.86	0.12	-0.991	20.933	116.79	53.92	-1.06	13.97	-3.85
66.27	18.41										
36	SAGEEND	-47.40	-20.06	0.31	-0.915	19.974	128.79	53.38	-1.34	27.75	3.33
77.44	21.51										
37	SAGEEND	-58.71	-24.05	0.48	-0.769	18.862	140.79	52.87	-1.60	28.82	3.56
78.05	21.68										
38	SAGEEND	-70.11	-27.82	0.62	-0.624	17.726	152.79	52.38	-1.85	29.19	3.47
78.10	21.69										
39	SAGEEND	-81.57	-31.36	0.73	-0.485	16.575	164.79	51.92	-2.09	29.52	3.33
78.13	21.70										
40	SAGEEND	-93.11	-34.66	0.81	-0.352	15.411	176.79	51.50	-2.31	29.85	3.20
78.16	21.71										
41	SAGEEND	-104.71	-37.73	0.87	-0.225	14.234	188.79	51.10	-2.52	30.20	3.07
78.18	21.72										
42	SAGEEND	-116.37	-40.56	0.90	-0.104	13.043	200.79	50.73	-2.70	30.55	2.94
78.20	21.72										
43	SAGEEND	-128.09	-43.15	0.91	0.009	11.840	212.79	50.40	-2.88	30.86	2.77
78.20	21.72										
44	SAGEEND	-139.86	-45.49	0.90	0.115	10.627	224.79	50.10	-3.03	31.11	2.58
78.18	21.72										
45	SAGEEND	-151.67	-47.57	0.87	0.213	9.404	236.79	49.83	-3.17	31.33	2.38
78.14	21.71										
46	SAGEEND	-163.53	-49.41	0.81	0.304	8.175	248.79	49.60	-3.29	31.52	2.19
78.09	21.69										
47	SAGEEND	-175.43	-50.98	0.74	0.385	6.935	260.79	49.39	-3.40	31.66	1.99
78.02	21.67										
48	SAGEEND	-187.35	-52.30	0.65	0.459	5.688	272.79	49.23	-3.49	31.81	1.84
77.94	21.65										
49	SAGEEND	-199.31	-53.36	0.55	0.529	4.437	284.79	49.09	-3.56	31.96	1.78
77.87	21.63										
50	SAGEEND	-211.28	-54.16	0.43	0.597	3.181	296.79	48.99	-3.61	32.07	1.79
77.79	21.61										
51	SAGEEND	-223.27	-54.69	0.30	0.664	1.924	308.79	48.92	-3.64	31.99	1.66
77.60	21.55										
52	SAGEEND	-235.26	-54.97	0.16	0.703	0.698	320.79	48.89	-3.66	29.10	-1.23
75.08	20.86										
53	SEABED	-247.26	-55.02	0.03	0.376	0.034	332.79	48.88	-3.66	4.72	-13.96
63.00	17.50										
54	SEABED	-259.26	-55.02	0.00	0.019	-0.001	344.79	48.88	-3.66	0.04	-2.59
52.86	14.68										
55	SEABED	-271.26	-55.02	0.00	-0.001	0.000	356.79	48.88	-3.66	-0.01	-0.02
50.83	14.12										

56	SEABED	-283.26	-55.02	0.00	0.000	0.000	368.79	48.88	-3.66	0.00	0.01
50.82	14.12										
57	SEABED	-295.26	-55.02	0.00	0.000	0.000	380.79	48.88	-3.66	0.00	0.00
50.81	14.11										
58	SEABED	-307.26	-55.02	0.00	0.000	0.000	392.79	48.88	-3.66	0.00	0.00
50.81	14.11										
59	SEABED	-319.26	-55.02	0.00	0.000	0.000	404.79	48.88	-3.66	0.00	0.00
50.81	14.11										
60	SEABED	-331.26	-55.02	0.00	0.000	0.000	416.79	48.88	-3.66	0.00	0.00
50.81	14.11										

OFFPIPE - OFFSHORE PIPELINE ANALYSIS SYSTEM - VERSION 2.05 AC DATE - 5/ 6/2020 TIME - 21: 6:22
PAGE 106
PROJECT - TUGAS AKHIR JOB NO. - ANALISIS
DINPMIS
USER ID - IDA BAGUS PONDHARA SARWANARY LICENSED TO: RICKY TAMEKAL CASE
7

NODE TOTAL	PIPE PERCENT	X COORD	Y COORD	Z COORD	HORIZ ANGLE	VERT ANGLE	PIPE LENGIH	TENSILE STRESS	HOOP STRESS	BENDING STRESSES	
										VERT	HORIZ
NO.	SECTION YIELD	(M)	(M)	(M)	(DEG)	(DEG)	(M)	(MPA)	(MPA)	(MPA)	(MPA)
1	TENSIONR	77.79	6.21	0.00	0.000	0.319	0.00	56.89	0.00	0.00	0.00
56.89	15.80										
3	LAYARGE	71.49	6.16	0.00	0.000	0.959	6.30	56.87	0.00	-109.03	0.00
149.55	41.54										
5	LAYARGE	65.37	5.99	0.00	0.000	2.220	12.42	56.85	0.00	-78.84	0.00
123.86	34.41										
7	LAYARGE	59.91	5.72	0.00	0.000	3.299	17.89	56.81	0.00	-89.84	0.00
133.17	36.99										
9	LAYARGE	53.32	5.28	0.00	0.000	4.483	24.49	56.73	0.00	-86.50	0.00
130.26	36.18										
11	LAYARGE	47.32	4.74	0.00	0.000	5.787	30.51	56.65	0.00	-107.24	0.00
147.80	41.05										
13	LAYARGE	38.21	3.69	0.00	0.000	7.420	39.68	56.48	0.00	-129.87	0.00
166.86	46.35										
15	LAYARGE	29.27	2.39	0.00	0.000	9.060	48.72	56.28	0.00	-106.27	0.01
146.60	40.72										
17	LAYARGE	23.13	1.33	0.00	0.000	10.380	54.95	56.11	0.00	-87.65	-0.07
130.62	36.28										

19	LAYARGE	17.18	0.19	0.00	0.001	11.411	61.01	55.93	0.00	-70.05	0.30
115.46	32.07										
21	LAYARGE	10.63	-1.22	0.00	-0.020	13.210	67.72	55.72	-0.08	-167.88	-5.26
198.51	55.14										
24	STINGER	-4.61	-5.09	0.00	0.021	15.143	83.44	55.23	-0.34	-144.82	-5.23
178.55	49.60										
26	STINGER	-11.02	-6.94	0.00	-0.004	16.603	90.11	55.01	-0.46	-50.05	-0.42
97.77	27.16										
28	STINGER	-17.40	-8.88	0.00	-0.001	17.445	96.77	54.76	-0.59	-69.80	-1.94
114.39	31.78										
30	STINGER	-23.74	-10.94	0.00	0.011	18.440	103.44	54.49	-0.73	-68.27	1.09
112.88	31.36										
32	STINGER	-30.05	-13.10	0.00	-0.051	19.315	110.11	54.22	-0.87	-55.28	-11.88
102.34	28.43										
34	STINGER	-36.32	-15.35	0.02	-0.538	20.195	116.77	53.92	-1.02	-71.47	-48.95
127.85	35.51										
36	SAGEEND	-47.57	-19.53	0.20	-0.940	20.075	128.77	53.39	-1.30	23.70	1.20
73.83	20.51										
37	SAGEEND	-58.87	-23.55	0.37	-0.817	19.007	140.77	52.87	-1.57	28.58	3.47
77.79	21.61										
38	SAGEEND	-70.26	-27.34	0.52	-0.672	17.874	152.77	52.38	-1.82	29.16	3.48
78.02	21.67										
39	SAGEEND	-81.71	-30.91	0.64	-0.532	16.726	164.77	51.92	-2.06	29.50	3.35
78.05	21.68										
40	SAGEEND	-93.24	-34.25	0.73	-0.398	15.565	176.77	51.49	-2.28	29.83	3.21
78.07	21.69										
41	SAGEEND	-104.83	-37.35	0.80	-0.270	14.388	188.77	51.09	-2.49	30.17	3.08
78.09	21.69										
42	SAGEEND	-116.48	-40.21	0.84	-0.149	13.198	200.77	50.72	-2.68	30.50	2.94
78.13	21.70										
43	SAGEEND	-128.20	-42.82	0.86	-0.034	11.997	212.77	50.38	-2.86	30.84	2.78
78.15	21.71										
44	SAGEEND	-139.96	-45.19	0.86	0.073	10.786	224.77	50.08	-3.01	31.12	2.60
78.15	21.71										
45	SAGEEND	-151.77	-47.31	0.83	0.171	9.563	236.77	49.80	-3.15	31.35	2.40
78.13	21.70										
46	SAGEEND	-163.62	-49.18	0.79	0.263	8.332	248.77	49.56	-3.28	31.51	2.21
78.08	21.69										
47	SAGEEND	-175.52	-50.79	0.72	0.345	7.095	260.77	49.36	-3.39	31.67	2.01
78.01	21.67										
48	SAGEEND	-187.44	-52.15	0.64	0.421	5.850	272.77	49.18	-3.48	31.84	1.85
77.93	21.65										
49	SAGEEND	-199.39	-53.24	0.55	0.490	4.601	284.77	49.04	-3.55	31.96	1.78
77.85	21.63										
50	SAGEEND	-211.36	-54.07	0.44	0.559	3.346	296.77	48.94	-3.60	32.09	1.77
77.78	21.61										
51	SAGEEND	-223.34	-54.64	0.32	0.627	2.088	308.77	48.87	-3.64	32.05	1.71
77.62	21.56										
52	SAGEEND	-235.34	-54.95	0.18	0.681	0.851	320.77	48.83	-3.66	29.98	0.53
75.82	21.06										
53	SEABED	-247.34	-55.02	0.05	0.475	0.057	332.77	48.82	-3.66	6.95	-12.99
62.69	17.41										
54	SEABED	-259.34	-55.03	0.00	0.036	-0.001	344.77	48.82	-3.66	0.12	-4.15
54.14	15.04										
55	SEABED	-271.34	-55.02	0.00	0.000	0.000	356.77	48.82	-3.66	-0.01	-0.08
50.81	14.11										
56	SEABED	-283.34	-55.02	0.00	0.000	0.000	368.77	48.82	-3.66	0.00	0.01
50.76	14.10										
57	SEABED	-295.34	-55.02	0.00	0.000	0.000	380.77	48.82	-3.66	0.00	0.00
50.75	14.10										
58	SEABED	-307.34	-55.02	0.00	0.000	0.000	392.77	48.82	-3.66	0.00	0.00
50.75	14.10										
59	SEABED	-319.34	-55.02	0.00	0.000	0.000	404.77	48.82	-3.66	0.00	0.00
50.75	14.10										
60	SEABED	-331.34	-55.02	0.00	0.000	0.000	416.77	48.82	-3.66	0.00	0.00
50.75	14.10										

OFFPIPE - OFFSHORE PIPELINE ANALYSIS SYSTEM - VERSION 2.05 AC DATE - 5/ 6/2020 TIME - 21: 6:22
PAGE 106
PROJECT - TUGAS AKHIR JOB NO. - ANALISIS
DINAMIS
USER ID - IDA BAGUS FUNDHARA SAKYANARY LICENSED TO: RICKY TAMEKAL CASE
8

NODE TOTAL NO. STRESS (MPA)	PIPE PERCENT SECTION YIELD (PCT)	X COORD (M)	Y COORD (M)	Z COORD (M)	HORIZ ANGLE (DEG)	VERT ANGLE (DEG)	PIPE LENGIH (M)	TENSILE STRESS (MPA)	HOOP STRESS (MPA)	BENDING STRESSES VERT (MPA)	HORIZ (MPA)
1	TENSIONR	77.79	6.21	0.00	0.000	0.322	0.00	65.05	0.00	0.00	0.00
65.05	18.07										
3	LAYBARGE	71.49	6.16	0.00	0.000	0.961	6.30	65.03	0.00	-111.46	0.00
159.77	44.38										
5	LAYBARGE	65.37	5.99	0.00	0.000	2.219	12.42	65.01	0.00	-80.99	0.00
133.84	37.18										
7	LAYBARGE	59.91	5.73	0.00	0.000	3.301	17.89	64.96	0.00	-92.13	0.00
143.27	39.80										
9	LAYBARGE	53.32	5.28	0.00	0.000	4.482	24.49	64.89	0.00	-88.85	0.00
140.42	39.00										
11	LAYBARGE	47.32	4.74	0.00	0.000	5.793	30.51	64.80	0.00	-111.01	0.00
159.16	44.21										
13	LAYBARGE	38.21	3.69	0.00	0.000	7.421	39.68	64.63	0.00	-135.23	0.00
179.57	49.88										
15	LAYBARGE	29.27	2.39	0.00	0.000	9.055	48.72	64.43	0.00	-110.08	0.01
158.00	43.89										
17	LAYBARGE	23.13	1.33	0.00	0.000	10.381	54.95	64.27	0.00	-89.90	-0.05
140.68	39.08										
19	LAYBARGE	17.18	0.19	0.00	0.001	11.409	61.01	64.09	0.00	-71.54	0.25
124.90	34.69										
21	LAYBARGE	10.63	-1.23	0.00	-0.019	13.239	67.72	63.87	-0.08	-178.31	-5.14
215.49	59.86										
24	STINGER	-4.64	-5.13	0.00	0.015	15.756	83.47	63.36	-0.34	-224.07	-5.88
254.00	70.56										
26	STINGER	-11.01	-7.10	0.00	0.018	18.270	90.14	63.14	-0.47	-109.43	4.90
156.42	43.45										
28	STINGER	-17.31	-9.28	0.01	-0.455	19.841	96.81	62.86	-0.62	-107.51	-63.50
169.15	46.98										
30	STINGER	-23.56	-11.60	0.10	-1.005	20.473	103.47	62.57	-0.77	8.14	-5.10
70.75	19.65										
32	STINGER	-29.81	-13.91	0.21	-1.006	20.090	110.14	62.27	-0.93	22.37	2.33
81.60	22.67										

34	STINGER	-36.08	-16.18	0.32	-0.939	19.576	116.81	61.98	-1.08	24.35	3.18
83.14	23.09										
36	SAGEBND	-47.42	-20.10	0.49	-0.806	18.611	128.81	61.48	-1.34	24.90	3.21
83.27	23.13										
37	SAGEBND	-58.82	-23.83	0.64	-0.676	17.628	140.81	60.99	-1.59	25.19	3.12
83.19	23.11										
38	SAGEBND	-70.29	-27.37	0.76	-0.551	16.635	152.81	60.54	-1.83	25.45	3.02
83.12	23.09										
39	SAGEBND	-81.82	-30.70	0.86	-0.430	15.633	164.81	60.11	-2.05	25.69	2.91
83.05	23.07										
40	SAGEBND	-93.40	-33.83	0.94	-0.314	14.622	176.81	59.70	-2.26	25.92	2.80
82.98	23.05										
41	SAGEBND	-105.04	-36.76	0.99	-0.203	13.599	188.81	59.33	-2.45	26.17	2.70
82.91	23.03										
42	SAGEBND	-116.72	-39.47	1.02	-0.097	12.568	200.81	58.98	-2.63	26.43	2.59
82.85	23.01										
43	SAGEBND	-128.46	-41.98	1.03	0.004	11.526	212.81	58.65	-2.80	26.66	2.46
82.79	23.00										
44	SAGEBND	-140.24	-44.27	1.02	0.099	10.481	224.81	58.36	-2.95	26.86	2.32
82.72	22.98										
45	SAGEBND	-152.06	-46.34	0.99	0.187	9.425	236.81	58.09	-3.09	27.02	2.15
82.65	22.96										
46	SAGEBND	-163.91	-48.20	0.94	0.269	8.364	248.81	57.85	-3.21	27.15	2.00
82.58	22.94										
47	SAGEBND	-175.80	-49.83	0.88	0.344	7.298	260.81	57.64	-3.32	27.26	1.84
82.51	22.92										
48	SAGEBND	-187.72	-51.25	0.80	0.413	6.227	272.81	57.46	-3.42	27.39	1.70
82.43	22.90										
49	SAGEBND	-199.66	-52.44	0.71	0.477	5.153	284.81	57.31	-3.49	27.51	1.59
82.35	22.88										
50	SAGEBND	-211.62	-53.40	0.60	0.536	4.073	296.81	57.19	-3.56	27.61	1.54
82.28	22.85										
51	SAGEBND	-223.60	-54.14	0.48	0.595	2.990	308.81	57.09	-3.61	27.69	1.54
82.21	22.83										
52	SAGEBND	-235.58	-54.65	0.35	0.653	1.905	320.81	57.03	-3.64	27.66	1.52
82.09	22.80										
53	SAGEBND	-247.58	-54.94	0.21	0.703	0.833	332.81	56.99	-3.66	26.35	0.71
80.88	22.47										
54	SEAFED	-259.58	-55.02	0.07	0.559	0.076	344.81	56.98	-3.66	7.78	-10.92
69.56	19.32										
55	SEAFED	-271.58	-55.02	0.00	0.080	0.001	356.81	56.98	-3.66	0.31	-7.10
64.60	17.94										
56	SEAFED	-283.58	-55.02	0.00	0.001	0.000	368.81	56.98	-3.66	-0.01	-0.36
59.17	16.44										
57	SEAFED	-295.58	-55.02	0.00	0.000	0.000	380.81	56.98	-3.66	0.00	0.00
58.90	16.36										
58	SEAFED	-307.58	-55.02	0.00	0.000	0.000	392.81	56.98	-3.66	0.00	0.00
58.90	16.36										
59	SEAFED	-319.58	-55.02	0.00	0.000	0.000	404.81	56.98	-3.66	0.00	0.00
58.90	16.36										
60	SEAFED	-331.58	-55.02	0.00	0.000	0.000	416.81	56.98	-3.66	0.00	0.00
58.90	16.36										

OFFPIPE - OFFSHORE PIPELINE ANALYSIS SYSTEM - VERSION 2.05 AC DATE - 5/ 6/2020 TIME - 21: 6:22
PAGE 106
PROJECT - TUGAS AKHIR JOB NO. - ANALISIS
DINEMIS
USER ID - IDA BAGUS FUNDHARA SAKYANARY LICENSED TO: RICKY TAMEKAL CASE
9

NODE TOTAL NO. STRESS (MPA)	PIPE PERCENT SECTION YIELD (PCT)	X COORD (M)	Y COORD (M)	Z COORD (M)	HORIZ ANGLE (DEG)	VERT ANGLE (DEG)	PIPE LENGIH (M)	TENSILE STRESS (MPA)	HOOP STRESS (MPA)	BENDING VERT (MPA)	STRESSES HORIZ (MPA)
1	TENSIONR	77.79	6.21	0.00	0.000	0.321	0.00	65.02	0.00	0.00	0.00
65.02	18.06										
3	LAYBARGE	71.49	6.16	0.00	0.000	0.959	6.30	65.00	0.00	-111.45	0.00
159.72	44.37										
5	LAYBARGE	65.38	5.99	0.00	0.000	2.217	12.42	64.98	0.00	-80.97	0.00
133.80	37.17										
7	LAYBARGE	59.91	5.72	0.00	0.000	3.300	17.89	64.93	0.00	-92.11	0.00
143.23	39.78										
9	LAYBARGE	53.32	5.27	0.00	0.000	4.480	24.49	64.86	0.00	-88.84	0.00
140.38	38.99										
11	LAYBARGE	47.32	4.74	0.00	0.000	5.791	30.51	64.78	0.00	-110.99	0.00
159.11	44.20										
13	LAYBARGE	38.22	3.69	0.00	0.000	7.419	39.68	64.60	0.00	-135.20	0.00
179.52	49.87										
15	LAYBARGE	29.27	2.39	0.00	0.000	9.054	48.72	64.40	0.00	-110.07	0.01
157.96	43.88										
17	LAYBARGE	23.13	1.33	0.00	0.000	10.379	54.95	64.24	0.00	-89.83	-0.06
140.59	39.05										
19	LAYBARGE	17.18	0.19	0.00	0.001	11.409	61.01	64.06	0.00	-71.86	0.26
125.13	34.76										
21	LAYBARGE	10.63	-1.22	0.00	-0.019	13.230	67.72	63.85	-0.08	-176.79	-5.18
214.20	59.50										
24	STINGER	-4.62	-5.11	0.00	0.019	15.333	83.45	63.35	-0.34	-175.94	-5.21
213.11	59.20										
26	STINGER	-11.02	-6.99	0.00	-0.002	17.160	90.12	63.14	-0.47	-71.40	-0.38
124.01	34.45										
28	STINGER	-17.37	-9.02	0.00	-0.008	18.289	96.78	62.87	-0.60	-88.59	-4.23
138.39	38.44										
30	STINGER	-23.67	-11.18	0.01	-0.422	19.471	103.45	62.59	-0.75	-77.81	-48.86
140.71	39.09										
32	STINGER	-29.95	-13.44	0.09	-0.905	19.960	110.12	62.31	-0.90	-3.99	-12.21
73.26	20.35										
34	STINGER	-36.22	-15.70	0.20	-0.963	19.657	116.79	62.02	-1.05	21.46	1.66
80.41	22.34										
36	SAGEBND	-47.55	-19.65	0.38	-0.845	18.722	128.79	61.51	-1.31	24.76	3.16
83.09	23.08										
37	SAGEBND	-58.94	-23.40	0.53	-0.716	17.743	140.79	61.03	-1.56	25.18	3.14
83.15	23.10										
38	SAGEBND	-70.40	-26.96	0.66	-0.590	16.752	152.79	60.57	-1.80	25.43	3.05
83.09	23.08										
39	SAGEBND	-81.92	-30.32	0.77	-0.468	15.750	164.79	60.13	-2.02	25.66	2.93
83.02	23.06										
40	SAGEBND	-93.50	-33.48	0.85	-0.352	14.739	176.79	59.73	-2.23	25.90	2.82
82.96	23.04										
41	SAGEBND	-105.13	-36.43	0.91	-0.240	13.719	188.79	59.35	-2.43	26.13	2.72
82.90	23.03										

42	SAGEBND	-116.81	-39.17	0.95	-0.134	12.689	200.79	58.99	-2.61	26.40	2.61
82.84	23.01										
43	SAGEBND	-128.54	-41.70	0.97	-0.032	11.650	212.79	58.67	-2.78	26.64	2.49
82.77	22.99										
44	SAGEBND	-140.32	-44.01	0.97	0.063	10.603	224.79	58.37	-2.93	26.85	2.34
82.71	22.97										
45	SAGEBND	-152.13	-46.11	0.94	0.152	9.549	236.79	58.10	-3.07	27.02	2.18
82.65	22.96										
46	SAGEBND	-163.98	-48.00	0.90	0.235	8.490	248.79	57.86	-3.20	27.17	2.03
82.58	22.94										
47	SAGEBND	-175.87	-49.66	0.85	0.311	7.425	260.79	57.65	-3.31	27.27	1.86
82.50	22.92										
48	SAGEBND	-187.78	-51.10	0.77	0.381	6.353	272.79	57.46	-3.41	27.37	1.71
82.41	22.89										
49	SAGEBND	-199.72	-52.31	0.69	0.445	5.277	284.79	57.31	-3.49	27.47	1.60
82.34	22.87										
50	SAGEBND	-211.68	-53.30	0.59	0.505	4.198	296.79	57.18	-3.55	27.58	1.55
82.26	22.85										
51	SAGEBND	-223.65	-54.07	0.48	0.563	3.115	308.79	57.08	-3.60	27.67	1.55
82.19	22.83										
52	SAGEBND	-235.64	-54.61	0.35	0.622	2.031	320.79	57.01	-3.64	27.69	1.53
82.09	22.80										
53	SAGEBND	-247.63	-54.92	0.22	0.675	0.956	332.79	56.97	-3.66	26.69	0.94
81.18	22.55										
54	SEAFED	-259.63	-55.02	0.08	0.587	0.114	344.79	56.96	-3.66	10.46	-9.61
70.09	19.47										
55	SEAFED	-271.63	-55.02	0.01	0.106	0.002	356.79	56.96	-3.66	0.51	-8.58
65.87	18.30										
56	SEAFED	-283.63	-55.02	0.00	0.002	0.000	368.79	56.96	-3.66	-0.01	-0.50
59.28	16.47										
57	SEAFED	-295.63	-55.02	0.00	0.000	0.000	380.79	56.96	-3.66	0.00	0.00
58.88	16.36										
58	SEAFED	-307.63	-55.02	0.00	0.000	0.000	392.79	56.96	-3.66	0.00	0.00
58.88	16.36										
59	SEAFED	-319.63	-55.02	0.00	0.000	0.000	404.79	56.96	-3.66	0.00	0.00
58.88	16.36										
60	SEAFED	-331.63	-55.02	0.00	0.000	0.000	416.79	56.96	-3.66	0.00	0.00
58.88	16.36										

GRAFIK ANALISA DINAMIS HEADING 135°

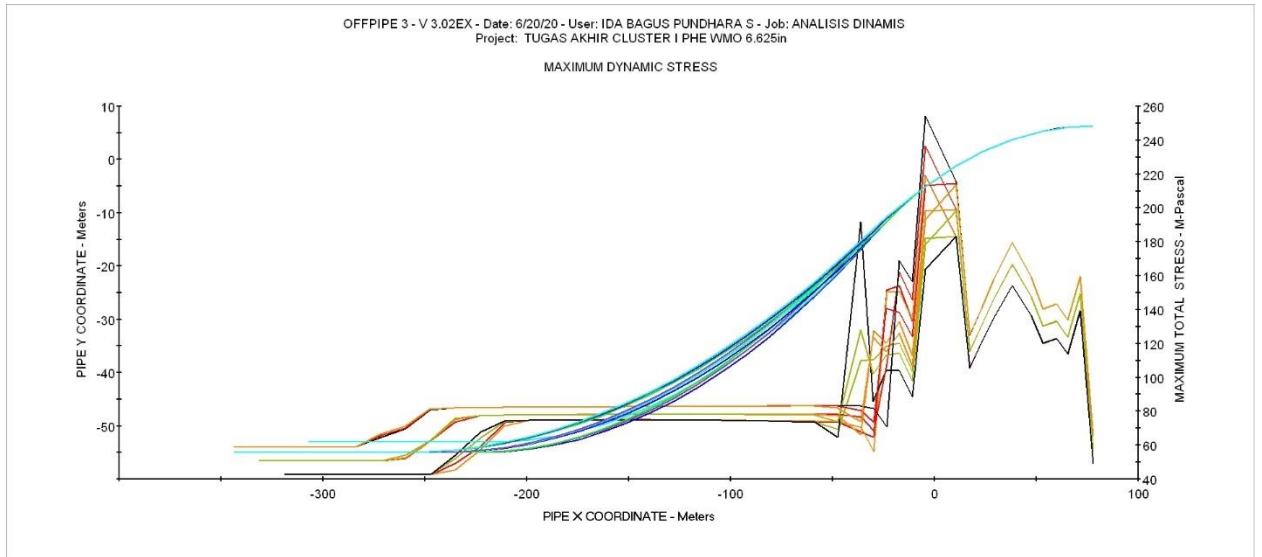

OUTPUT REGANGAN ANALISA DINAMIS HEADING 135°

SOLUTION SUMMARY									
NODE	ELEMENT	X	Y	Z	SUPPORT	REACT	TOTAL	TOTAL	ECT
NO.	SECTION	COORD	COORD	COORD	VERT	HORIZ	MOMENT	STRAIN	ALL
		(M)	(M)	(M)	(KN)	(KN)	(KN-M)	(ECT)	(%)
1	TENSIONR	77.8	6.2	0.0	-2.6	-0.1	0.0	0.018	0.
3	LAYBARGE	71.5	6.2	0.0	23.7	-0.2	47.1	0.055	0.
5	LAYBARGE	65.4	6.0	0.0	10.2	-0.1	33.9	0.049	0.

7	LAYBARGE	59.9	5.7	0.0	14.7	0.1	38.3	0.064	0.
9	LAYBARGE	53.3	5.3	0.0	13.2	0.1	36.9	0.052	0.
11	LAYBARGE	47.3	4.7	0.0	17.4	0.1	42.1	0.039	0.
13	LAYBARGE	38.2	3.7	0.0	21.8	-0.1	47.7	0.045	0.
15	LAYBARGE	29.3	2.4	0.0	17.2	0.1	41.7	0.068	0.
17	LAYBARGE	23.1	1.3	0.0	13.9	-0.1	37.5	0.053	0.
19	LAYBARGE	17.2	0.2	0.0	8.5	-0.2	32.8	0.047	0.
21	LAYBARGE	10.6	-1.2	0.0	21.3	-1.7	54.9	0.074	0.
24	STINGER	-4.6	-5.1	0.0	27.3	-1.5	74.6	0.103	0.
26	STINGER	-11.0	-7.1	0.0	9.1	-1.6	48.1	0.065	0.
28	STINGER	-17.3	-9.3	0.0	16.8	4.4	56.5	0.055	0.
30	STINGER	-23.5	-11.7	0.0	17.5	-8.8	54.7	0.042	0.
32	STINGER	-29.7	-14.2	0.1	9.9	-5.7	31.5	0.055	0.
34	STINGER	-35.8	-16.9	0.2	0.0	0.0	8.9	0.067	0.
46	SAGEBEND	-162.8	-51.0	0.7	0.0	0.0	23.8	0.074	0.
50	SEABED	-210.7	-53.0	0.0	8.1	-3.9	9.3	0.046	0.

SOLUTION SUMMARY

NODE NO.	PIPE SECTION	X COORD (M)	Y COORD (M)	Z COORD (M)	SUPPORT VERT (KN)	REACT HORIZ (KN)	TOTAL MOMENT (KN-M)	TOTAL STRAIN (PCT)	PCT ALL (%)
1	TENSIONR	77.8	6.2	0.0	-2.6	-0.1	0.0	0.018	0.
3	LAYBARGE	71.5	6.2	0.0	23.7	-0.2	47.1	0.055	0.
5	LAYBARGE	65.4	6.0	0.0	10.2	-0.2	33.9	0.069	0.
7	LAYBARGE	59.9	5.7	0.0	14.8	-0.2	38.3	0.054	0.
9	LAYBARGE	53.3	5.3	0.0	13.3	-0.1	36.9	0.042	0.
11	LAYBARGE	47.3	4.7	0.0	17.5	-0.2	42.1	0.069	0.
13	LAYBARGE	38.2	3.7	0.0	21.8	-0.2	47.7	0.065	0.
15	LAYBARGE	29.3	2.4	0.0	17.2	0.1	41.7	0.048	0.
17	LAYBARGE	23.1	1.3	0.0	14.0	-0.1	37.6	0.053	0.
19	LAYBARGE	17.2	0.2	0.0	8.1	-0.2	32.3	0.066	0.
21	LAYBARGE	10.6	-1.2	0.0	22.5	-1.7	56.8	0.089	0.
24	STINGER	-4.6	-5.1	0.0	22.2	-1.7	56.7	0.086	0.
26	STINGER	-11.0	-7.0	0.0	6.3	-0.6	31.6	0.065	0.
28	STINGER	-17.4	-9.0	0.0	11.7	-1.3	37.3	0.052	0.
30	STINGER	-23.7	-11.2	0.0	12.8	-1.8	38.5	0.064	0.
32	STINGER	-29.9	-13.5	0.0	10.5	3.9	36.5	0.030	0.
34	STINGER	-36.1	-15.9	0.0	19.3	-11.2	52.0	0.040	0.
46	SAGEBEND	-162.9	-50.7	0.7	0.0	0.0	23.8	0.054	0.
50	SEABED	-210.9	-53.0	0.1	7.3	-3.9	9.8	0.067	0.

SOLUTION SUMMARY

NODE NO.	PIPE SECTION	X COORD (M)	Y COORD (M)	Z COORD (M)	SUPPORT VERT (KN)	REACT HORIZ (KN)	TOTAL MOMENT (KN-M)	TOTAL STRAIN (PCT)	PCT ALL (%)
1	TENSIONR	77.8	6.2	0.0	-2.6	-0.1	0.0	0.018	0.

3	LAYBARGE	71.5	6.2	0.0	23.7	-0.2	47.1	0.075	0.
5	LAYBARGE	65.4	6.0	0.0	10.2	0.1	33.9	0.049	0.
7	LAYBARGE	59.9	5.7	0.0	14.7	-0.1	38.3	0.064	0.
9	LAYBARGE	53.3	5.3	0.0	13.2	-0.1	36.9	0.042	0.
11	LAYBARGE	47.3	4.7	0.0	17.4	-0.1	42.1	0.029	0.
13	LAYBARGE	38.2	3.7	0.0	21.8	-0.2	47.7	0.035	0.
15	LAYBARGE	29.3	2.4	0.0	17.1	0.1	41.7	0.058	0.
17	LAYBARGE	23.1	1.3	0.0	14.1	-0.1	37.7	0.043	0.
19	LAYBARGE	17.2	0.2	0.0	7.9	-0.3	32.0	0.036	0.
21	LAYBARGE	10.6	-1.2	0.0	23.1	-1.7	57.7	0.057	0.
24	STINGER	-4.6	-5.1	0.0	19.7	-1.8	47.8	0.045	0.
26	STINGER	-11.0	-6.9	0.0	4.7	-0.3	23.1	0.055	0.
28	STINGER	-17.4	-8.9	0.0	10.8	-2.2	29.6	0.033	0.
30	STINGER	-23.7	-10.9	0.0	9.6	2.9	27.7	0.040	0.
32	STINGER	-30.0	-13.1	0.0	2.0	1.2	23.7	0.046	0.
34	STINGER	-36.3	-15.4	0.0	33.7	-13.7	83.9	0.113	0.
46	SAGEBND	-163.0	-50.5	0.7	0.0	0.0	23.8	0.054	0.
50	SEAFED	-210.9	-53.0	0.1	6.5	-3.7	10.8	0.038	0.

SOLUTION SUMMARY

NODE NO.	PIPE SECTION	X COORD (M)	Y COORD (M)	Z COORD (M)	SUPPORT VERT (KN)	REACT HORIZ (KN)	TOTAL MOMENT (KN-M)	TOTAL STRAIN (PCT)	PCT ALL (%)
----------	--------------	-----------------	-----------------	-----------------	-----------------------	----------------------	------------------------	------------------------	----------------

1	TENSIONR	77.8	6.2	0.0	-2.5	-0.1	0.0	0.024	0.
3	LAYBARGE	71.5	6.2	0.0	26.1	0.2	48.3	0.072	0.
5	LAYBARGE	65.4	6.0	0.0	12.2	0.1	34.9	0.066	0.
7	LAYBARGE	59.9	5.7	0.0	16.9	-0.1	39.4	0.042	0.
9	LAYBARGE	53.3	5.3	0.0	15.3	-0.1	38.0	0.050	0.
11	LAYBARGE	47.3	4.7	0.0	20.1	0.1	43.9	0.067	0.
13	LAYBARGE	38.2	3.7	0.0	25.2	0.2	50.3	0.055	0.
15	LAYBARGE	29.3	2.4	0.0	19.9	0.1	43.5	0.076	0.
17	LAYBARGE	23.1	1.3	0.0	16.0	-0.1	38.6	0.050	0.
19	LAYBARGE	17.2	0.2	0.0	9.9	-0.3	33.1	0.063	0.
21	LAYBARGE	10.6	-1.2	0.0	25.9	-1.6	60.2	0.046	0.
24	STINGER	-4.6	-5.1	0.0	33.6	-2.8	81.0	0.111	0.
26	STINGER	-11.0	-7.1	0.0	12.9	5.5	50.9	0.044	0.
28	STINGER	-17.3	-9.3	0.0	22.8	-12.9	59.1	0.053	0.
30	STINGER	-23.5	-11.6	0.1	5.3	-3.1	17.8	0.065	0.
32	STINGER	-29.8	-14.0	0.2	0.0	0.0	9.7	0.044	0.
34	STINGER	-36.0	-16.4	0.3	0.0	0.0	13.7	0.069	0.
44	SAGEBND	-140.0	-44.8	1.1	0.0	0.0	16.7	0.072	0.
52	SEAFED	-235.5	-53.0	0.1	5.5	-3.3	9.4	0.063	0.

SOLUTION SUMMARY

NODE NO.	PIPE SECTION	X COORD (M)	Y COORD (M)	Z COORD (M)	SUPPORT VERT (KN)	REACT HORIZ (KN)	TOTAL MOMENT (KN-M)	TOTAL STRAIN (PCT)	PCT ALL (%)
----------	--------------	-----------------	-----------------	-----------------	-----------------------	----------------------	------------------------	------------------------	----------------

1	TENSIONR	77.8	6.2	0.0	-2.5	-0.1	0.0	0.024	0.
3	LAYBARGE	71.5	6.2	0.0	26.0	0.2	48.2	0.052	0.
5	LAYBARGE	65.4	6.0	0.0	12.2	0.1	34.9	0.066	0.
7	LAYBARGE	59.9	5.7	0.0	16.8	0.1	39.4	0.062	0.
9	LAYBARGE	53.3	5.3	0.0	15.3	0.1	38.0	0.050	0.
11	LAYBARGE	47.3	4.7	0.0	20.1	0.1	43.9	0.077	0.
13	LAYBARGE	38.2	3.7	0.0	25.1	0.2	50.3	0.054	0.
15	LAYBARGE	29.3	2.4	0.0	19.8	0.1	43.5	0.046	0.
17	LAYBARGE	23.1	1.3	0.0	16.1	-0.1	38.7	0.070	0.
19	LAYBARGE	17.2	0.2	0.0	9.5	-0.2	32.7	0.053	0.
21	LAYBARGE	10.6	-1.2	0.0	27.0	-1.7	61.6	0.130	0.
24	STINGER	-4.6	-5.1	0.0	26.7	-1.6	61.4	0.092	0.
26	STINGER	-11.0	-7.0	0.0	8.2	-1.4	32.6	0.043	0.
28	STINGER	-17.4	-9.0	0.0	15.8	3.1	40.6	0.062	0.
30	STINGER	-23.7	-11.2	0.0	13.6	-7.5	36.7	0.076	0.
32	STINGER	-29.9	-13.5	0.1	11.3	-6.5	27.9	0.056	0.
34	STINGER	-36.2	-15.8	0.2	0.0	0.0	8.1	0.042	0.
42	SAGEBND	-116.6	-39.8	1.0	0.0	0.0	16.5	0.052	0.
52	SEABED	-235.6	-53.0	0.1	4.4	-2.7	10.9	0.064	0.

SOLUTION SUMMARY

NODE	FILE	X	Y	Z	SUPPORT	REACT	TOTAL	TOTAL	PCT
NO.	SECTION	COORD	COORD	COORD	VERT	HORIZ	MOMENT	STRAIN	ALL
		(M)	(M)	(M)	(KN)	(KN)	(KN-M)	(PCT)	(%)
1	TENSIONR	77.8	6.2	0.0	-2.5	0.1	0.0	0.024	0.
3	LAYBARGE	71.5	6.2	0.0	26.0	-0.2	48.2	0.042	0.
5	LAYBARGE	65.4	6.0	0.0	12.2	-0.1	34.9	0.036	0.
7	LAYBARGE	59.9	5.7	0.0	16.9	0.1	39.4	0.042	0.
9	LAYBARGE	53.3	5.3	0.0	15.3	0.1	38.0	0.060	0.
11	LAYBARGE	47.3	4.7	0.0	20.1	0.1	43.9	0.057	0.
13	LAYBARGE	38.2	3.7	0.0	25.1	0.1	50.3	0.064	0.
15	LAYBARGE	29.3	2.4	0.0	19.8	0.1	43.5	0.046	0.
17	LAYBARGE	23.1	1.3	0.0	16.2	-0.1	38.7	0.050	0.
19	LAYBARGE	17.2	0.2	0.0	9.4	-0.2	32.6	0.063	0.
21	LAYBARGE	10.6	-1.2	0.0	27.5	-1.7	62.2	0.094	0.
24	STINGER	-4.6	-5.1	0.0	23.5	-1.7	51.9	0.066	0.
26	STINGER	-11.0	-6.9	0.0	5.7	-0.7	23.5	0.051	0.
28	STINGER	-17.4	-8.9	0.0	13.1	-1.6	31.1	0.071	0.
30	STINGER	-23.7	-10.9	0.0	11.9	2.5	30.1	0.069	0.
32	STINGER	-30.0	-13.1	0.0	10.8	-6.0	27.6	0.055	0.
34	STINGER	-36.3	-15.3	0.1	12.2	-7.0	28.4	0.037	0.
44	SAGEBND	-140.2	-44.3	1.0	0.0	0.0	16.7	0.052	0.
52	SEABED	-235.7	-53.0	0.1	3.6	-2.2	12.3	0.066	0.

SOLUTION SUMMARY

NODE	FILE	X	Y	Z	SUPPORT	REACT	TOTAL	TOTAL	PCT
------	------	---	---	---	---------	-------	-------	-------	-----

NO.	SECTION	COORD (M)	COORD (M)	COORD (M)	VERT (KN)	HORIZ (KN)	MOMENT (KN-M)	STRAIN (PCT)	ALL (%)
1	TENSIONR	77.8	6.2	0.0	-2.6	-0.1	0.0	0.018	0.
3	LAYBARGE	71.5	6.2	0.0	23.8	0.2	47.1	0.075	0.
5	LAYBARGE	65.4	6.0	0.0	10.3	0.1	33.9	0.059	0.
7	LAYBARGE	59.9	5.7	0.0	14.8	0.1	38.3	0.064	0.
9	LAYBARGE	53.3	5.3	0.0	13.3	0.1	36.9	0.062	0.
11	LAYBARGE	47.3	4.7	0.0	17.5	0.1	42.2	0.069	0.
13	LAYBARGE	38.2	3.7	0.0	21.9	0.1	47.7	0.075	0.
15	LAYBARGE	29.3	2.4	0.0	17.2	0.1	41.8	0.068	0.
17	LAYBARGE	23.1	1.3	0.0	13.9	-0.1	37.5	0.063	0.
19	LAYBARGE	17.2	0.2	0.0	8.6	-0.2	32.8	0.057	0.
21	LAYBARGE	10.6	-1.2	0.0	21.3	-1.7	54.9	0.084	0.
24	STINGER	-4.6	-5.1	0.0	27.4	-1.7	74.7	0.107	0.
26	STINGER	-11.0	-7.1	0.0	9.1	-1.1	48.2	0.075	0.
28	STINGER	-17.3	-9.3	0.0	17.1	2.5	56.7	0.085	0.
30	STINGER	-23.5	-11.7	0.0	16.0	-3.7	54.4	0.082	0.
32	STINGER	-29.7	-14.3	0.0	16.6	-9.5	49.6	0.077	0.
34	STINGER	-35.8	-17.0	0.1	0.0	0.0	6.2	0.024	0.
47	SAGEBND	-174.1	-54.5	0.6	0.0	0.0	24.1	0.044	0.
50	SEABED	-210.0	-56.0	0.1	5.3	-3.1	13.0	0.031	0.

SOLUTION SUMMARY

NODE	PILE	X	Y	Z	SUPPORT	REACT	TOTAL	TOTAL	PCT
NO.	SECTION	COORD (M)	COORD (M)	COORD (M)	VERT (KN)	HORIZ (KN)	MOMENT (KN-M)	STRAIN (PCT)	ALL (%)
1	TENSIONR	77.8	6.2	0.0	-2.6	-0.1	0.0	0.018	0.
3	LAYBARGE	71.5	6.2	0.0	23.7	0.2	47.1	0.055	0.
5	LAYBARGE	65.4	6.0	0.0	10.2	-0.1	33.9	0.069	0.
7	LAYBARGE	59.9	5.7	0.0	14.7	-0.1	38.3	0.044	0.
9	LAYBARGE	53.3	5.3	0.0	13.3	-0.1	36.9	0.032	0.
11	LAYBARGE	47.3	4.7	0.0	17.5	-0.1	42.1	0.069	0.
13	LAYBARGE	38.2	3.7	0.0	21.8	-0.2	47.7	0.075	0.
15	LAYBARGE	29.3	2.4	0.0	17.2	0.1	41.7	0.058	0.
17	LAYBARGE	23.1	1.3	0.0	14.0	-0.1	37.6	0.043	0.
19	LAYBARGE	17.2	0.2	0.0	8.1	-0.2	32.3	0.036	0.
21	LAYBARGE	10.6	-1.2	0.0	22.5	-1.7	56.8	0.046	0.
24	STINGER	-4.6	-5.1	0.0	22.2	-1.7	56.7	0.086	0.
26	STINGER	-11.0	-7.0	0.0	6.3	-0.6	31.5	0.055	0.
28	STINGER	-17.4	-9.0	0.0	12.2	-1.1	37.8	0.043	0.
30	STINGER	-23.7	-11.2	0.0	11.6	-1.8	36.9	0.071	0.
32	STINGER	-29.9	-13.5	0.0	7.7	4.5	34.4	0.068	0.
34	STINGER	-36.1	-15.9	0.0	24.7	-14.1	67.9	0.093	0.
46	SAGEBND	-162.3	-52.9	0.7	0.0	0.0	24.1	0.044	0.
50	SEABED	-210.2	-56.0	0.1	3.6	-2.1	16.7	0.055	0.

SOLUTION SUMMARY									
NODE	PIPE	X	Y	Z	SUPPORT	REACT	TOTAL	TOTAL	PCT
NO.	SECTION	COORD	COORD	COORD	VERT	HORIZ	MOMENT	STRAIN	ALL
		(M)	(M)	(M)	(KN)	(KN)	(KN-M)	(PCT)	(%)
1	TENSIONR	77.8	6.2	0.0	-2.6	-0.1	0.0	0.018	0.
3	LAYBARGE	71.5	6.2	0.0	23.7	0.2	47.1	0.055	0.
5	LAYBARGE	65.4	6.0	0.0	10.2	0.1	33.9	0.069	0.
7	LAYBARGE	59.9	5.7	0.0	14.8	0.1	38.3	0.044	0.
9	LAYBARGE	53.3	5.3	0.0	13.3	0.1	36.9	0.052	0.
11	LAYBARGE	47.3	4.7	0.0	17.5	0.1	42.1	0.069	0.
13	LAYBARGE	38.2	3.7	0.0	21.8	0.1	47.7	0.045	0.
15	LAYBARGE	29.3	2.4	0.0	17.1	0.1	41.7	0.068	0.
17	LAYBARGE	23.1	1.3	0.0	14.1	-0.1	37.7	0.043	0.
19	LAYBARGE	17.2	0.2	0.0	7.9	-0.2	32.0	0.036	0.
21	LAYBARGE	10.6	-1.2	0.0	23.2	-1.7	57.8	0.057	0.
24	STINGER	-4.6	-5.1	0.0	19.8	-1.8	47.9	0.045	0.
26	STINGER	-11.0	-6.9	0.0	4.5	-0.3	22.9	0.065	0.
28	STINGER	-17.4	-8.9	0.0	11.5	-2.5	30.4	0.054	0.
30	STINGER	-23.7	-10.9	0.0	7.7	3.7	24.6	0.057	0.
32	STINGER	-30.1	-13.1	0.0	0.0	0.0	25.2	0.067	0.
34	STINGER	-36.3	-15.4	0.0	40.4	-13.5	101.7	0.095	0.
47	SAGEBND	-174.3	-54.0	0.6	0.0	0.0	24.2	0.044	0.
51	SEABED	-222.3	-56.0	0.0	8.3	-3.8	9.0	0.056	0.

OUTPUT ANALISA DINAMIS HEADING 180°

OFFPIPE - OFFSHORE PIPELINE ANALYSIS SYSTEM - VERSION 2.05 AC DATE - 5/ 6/2020 TIME - 21: 6:22
 PAGE 106
 PROJECT - TUGAS AKHIR JOB NO. - ANALISIS
 DINAMIS
 USER ID - IDA BAGUS HUNDHARA SAKYANARY LICENSED TO: RICKY IPWAKAL CASE
 1

NODE TOTAL NO. STRESS (MPA)	PIPE BEFORE SECTION YIELD (PCT)	X COORD (M)	Y COORD (M)	Z COORD (M)	HORIZ ANGLE (DEG)	VERT ANGLE (DEG)	PIPE LENGTH (M)	TENSILE STRESS (MPA)	HOOP STRESS (MPA)	BENDING STRESSES VERT (MPA)	HORIZ (MPA)
1	TENSIONR	77.79	6.21	0.00	0.000	0.313	0.00	48.73	0.00	0.00	0.00
48.73	13.54										
3	LAYARGE	71.49	6.16	0.00	0.000	0.955	6.30	48.72	0.00	-106.59	0.00
139.32	38.70										
5	LAYARGE	65.37	5.98	0.00	0.000	2.220	12.42	48.69	0.00	-76.70	0.00
113.89	31.64										
7	LAYARGE	59.91	5.72	0.00	0.000	3.295	17.89	48.65	0.00	-87.56	0.00
123.07	34.19										
9	LAYARGE	53.32	5.27	0.00	0.000	4.483	24.49	48.58	0.00	-84.15	0.00
120.11	33.36										
11	LAYARGE	47.32	4.74	0.00	0.000	5.779	30.51	48.49	0.00	-103.46	0.00
136.43	37.90										
13	LAYARGE	38.21	3.69	0.00	0.000	7.419	39.68	48.32	0.00	-124.48	0.00
154.13	42.81										
15	LAYARGE	29.27	2.39	0.00	0.000	9.062	48.72	48.12	0.00	-102.42	0.02
135.18	37.55										
17	LAYARGE	23.13	1.33	0.00	0.000	10.378	54.95	47.96	0.00	-85.49	-0.08
120.63	33.51										
19	LAYARGE	17.18	0.19	0.00	0.002	11.410	61.01	47.78	0.00	-68.24	0.34
105.71	29.36										
21	LAYARGE	10.63	-1.22	0.00	-0.022	13.186	67.72	47.57	-0.08	-159.09	-5.27
182.89	50.80										
24	STINGER	-4.64	-5.13	0.00	0.026	15.808	83.47	47.06	-0.34	-201.95	-4.67
218.91	60.81										
26	STINGER	-11.01	-7.10	0.00	-0.021	18.256	90.14	46.83	-0.47	-101.62	-3.13
133.48	37.08										
28	STINGER	-17.30	-9.29	0.00	0.071	20.058	96.81	46.55	-0.62	-125.96	10.91
154.27	42.85										
30	STINGER	-23.53	-11.68	0.00	-0.319	21.936	103.47	46.24	-0.78	-110.03	-57.14
151.39	42.05										
32	STINGER	-29.68	-14.24	0.08	-0.969	22.820	110.14	45.92	-0.95	-12.53	-17.71
64.65	17.96										
34	STINGER	-35.83	-16.81	0.19	-1.093	22.538	116.81	45.59	-1.12	25.70	1.04
67.57	18.77										
36	SAGEEND	-46.96	-21.30	0.39	-0.951	21.328	128.81	45.01	-1.42	32.85	4.11
73.54	20.43										
37	SAGEEND	-58.19	-25.54	0.56	-0.777	20.018	140.81	44.47	-1.70	33.80	4.16
74.00	20.56										
38	SAGEEND	-69.51	-29.51	0.70	-0.606	18.686	152.81	43.95	-1.97	34.35	4.01
74.15	20.60										
39	SAGEEND	-80.92	-33.22	0.80	-0.445	17.329	164.81	43.48	-2.22	34.85	3.84
74.32	20.64										
40	SAGEEND	-92.41	-36.66	0.88	-0.291	15.951	176.81	43.03	-2.44	35.36	3.69
74.47	20.69										
41	SAGEEND	-103.99	-39.82	0.92	-0.144	14.554	188.81	42.62	-2.65	35.88	3.52
74.60	20.72										
42	SAGEEND	-115.64	-42.69	0.93	-0.007	13.138	200.81	42.25	-2.85	36.37	3.31
74.72	20.76										
43	SAGEEND	-127.36	-45.27	0.92	0.120	11.705	212.81	41.92	-3.02	36.80	3.08
74.80	20.78										
44	SAGEEND	-139.14	-47.56	0.89	0.238	10.259	224.81	41.63	-3.17	37.13	2.83
74.85	20.79										
45	SAGEEND	-150.98	-49.54	0.83	0.345	8.800	236.81	41.37	-3.30	37.39	2.57
74.87	20.80										
46	SAGEEND	-162.86	-51.22	0.74	0.441	7.328	248.81	41.16	-3.41	37.61	2.33
74.85	20.79										
47	SAGEEND	-174.78	-52.60	0.64	0.528	5.845	260.81	40.98	-3.51	37.85	2.17
74.83	20.79										
48	SAGEEND	-186.73	-53.67	0.52	0.610	4.357	272.81	40.84	-3.58	38.05	2.11
74.80	20.78										

49	SAGEBD	-198.70	-54.42	0.39	0.691	2.864	284.81	40.75	-3.63	38.12	2.07
74.69	20.75										
50	SAGEBD	-210.69	-54.87	0.24	0.762	1.382	296.81	40.69	-3.65	36.79	1.25
73.43	20.40										
51	SEABD	-222.69	-55.02	0.08	0.662	0.176	308.81	40.67	-3.66	16.91	-11.51
59.19	16.44										
52	SEABD	-234.69	-55.03	0.00	0.082	-0.002	320.81	40.67	-3.66	0.43	-8.39
49.49	13.75										
53	SEABD	-246.69	-55.02	0.00	-0.001	0.000	332.81	40.67	-3.66	-0.04	-0.16
42.74	11.87										
54	SEABD	-258.69	-55.02	0.00	0.000	0.000	344.81	40.67	-3.66	0.00	0.02
42.64	11.84										
55	SEABD	-270.69	-55.02	0.00	0.000	0.000	356.81	40.67	-3.66	0.00	0.00
42.62	11.84										
56	SEABD	-282.69	-55.02	0.00	0.000	0.000	368.81	40.67	-3.66	0.00	0.00
42.62	11.84										
57	SEABD	-294.69	-55.02	0.00	0.000	0.000	380.81	40.67	-3.66	0.00	0.00
42.62	11.84										
58	SEABD	-306.69	-55.02	0.00	0.000	0.000	392.81	40.67	-3.66	0.00	0.00
42.62	11.84										

OFFPIPE - OFFSHORE PIPELINE ANALYSIS SYSTEM - VERSION 2.05 AC DATE - 5/ 6/2020 TIME - 21: 6:22
PAGE 106
PROJECT - TUGAS AKHIR JOB NO. - ANALISIS
DINAMIS
USER ID - IDA BAGUS PUNDHARA SAKYANARY LICENSED TO: RICKY TAMEKAL CASE
2

NODE	PIPE	X	Y	Z	HORIZ	VERT	PIPE	TENSILE	HOOP	BENDING	SIRESS
TOTAL	BERONT	COORD	COORD	COORD	ANGLE	ANGLE	LENGIH	SIRESS	SIRESS	VERT	HORIZ
NO.	SECTION	(M)	(M)	(M)	(DEG)	(DEG)	(M)	(MPA)	(MPA)	(MPA)	(MPA)
SIRESS	YIELD										
(MPA)	(PCT)										
1	TENSIONR	77.79	6.21	0.00	0.000	0.315	0.00	48.73	0.00	0.00	0.00
48.73	13.54										
3	LAYARGE	71.49	6.16	0.00	0.000	0.957	6.30	48.71	0.00	-106.60	0.00
139.30	38.69										
5	LAYARGE	65.38	5.98	0.00	0.000	2.222	12.42	48.69	0.00	-76.70	0.00
113.87	31.63										
7	LAYARGE	59.91	5.72	0.00	0.000	3.297	17.89	48.64	0.00	-87.56	0.00
123.06	34.18										

9	LAYARGE	53.32	5.27	0.00	0.000	4.485	24.49	48.57	0.00	-84.15	0.00
120.10	33.36										
11	LAYARGE	47.32	4.74	0.00	0.000	5.781	30.51	48.49	0.00	-103.46	0.00
136.41	37.89										
13	LAYARGE	38.21	3.69	0.00	0.000	7.421	39.68	48.32	0.00	-124.48	0.00
154.11	42.81										
15	LAYARGE	29.27	2.39	0.00	0.000	9.065	48.72	48.12	0.00	-102.42	0.01
135.17	37.55										
17	LAYARGE	23.13	1.33	0.00	0.000	10.380	54.95	47.95	0.00	-85.49	-0.07
120.62	33.50										
19	LAYARGE	17.18	0.19	0.00	0.002	11.412	61.01	47.77	0.00	-68.23	0.33
105.72	29.37										
21	LAYARGE	10.63	-1.22	0.00	-0.021	13.188	67.72	47.57	-0.08	-159.09	-5.23
182.88	50.80										
24	STINGER	-4.64	-5.13	0.00	0.023	15.809	83.47	47.05	-0.34	-201.77	-5.07
218.76	60.77										
26	STINGER	-11.00	-7.10	0.00	-0.009	18.263	90.14	46.83	-0.47	-102.52	-1.47
134.21	37.28										
28	STINGER	-17.30	-9.29	0.00	0.021	20.038	96.81	46.54	-0.62	-122.17	3.32
150.67	41.85										
30	STINGER	-23.53	-11.67	0.01	-0.490	21.822	103.47	46.24	-0.78	-105.26	-61.25
150.04	41.68										
32	STINGER	-29.70	-14.21	0.11	-1.084	22.475	110.14	45.92	-0.95	10.16	-6.54
56.18	15.60										
34	STINGER	-35.87	-16.73	0.23	-1.097	21.993	116.81	45.60	-1.12	28.93	2.61
70.54	19.59										
36	SAGEEND	-47.04	-21.11	0.43	-0.936	20.741	128.81	45.03	-1.41	33.14	4.24
73.88	20.52										
37	SAGEEND	-58.31	-25.23	0.59	-0.760	19.426	140.81	44.50	-1.68	33.91	4.22
74.19	20.61										
38	SAGEEND	-69.67	-29.09	0.73	-0.590	18.085	152.81	44.01	-1.94	34.44	4.08
74.32	20.65										
39	SAGEEND	-81.12	-32.68	0.83	-0.427	16.724	164.81	43.54	-2.18	34.93	3.92
74.44	20.68										
40	SAGEEND	-92.65	-35.99	0.90	-0.272	15.344	176.81	43.11	-2.40	35.45	3.79
74.61	20.72										
41	SAGEEND	-104.26	-39.03	0.94	-0.124	13.946	188.81	42.72	-2.60	35.95	3.65
74.75	20.76										
42	SAGEEND	-115.94	-41.77	0.95	0.015	12.530	200.81	42.37	-2.79	36.37	3.49
74.85	20.79										
43	SAGEEND	-127.69	-44.23	0.93	0.146	11.098	212.81	42.05	-2.95	36.74	3.30
74.91	20.81										
44	SAGEEND	-139.49	-46.39	0.89	0.268	9.651	224.81	41.78	-3.09	37.04	3.11
74.93	20.81										
45	SAGEEND	-151.34	-48.26	0.82	0.380	8.192	236.81	41.54	-3.22	37.33	2.95
74.94	20.82										
46	SAGEEND	-163.24	-49.81	0.73	0.484	6.723	248.81	41.34	-3.32	37.56	2.78
74.97	20.83										
47	SAGEEND	-175.18	-51.06	0.62	0.579	5.244	260.81	41.18	-3.40	37.78	2.68
74.96	20.82										
48	SAGEEND	-187.14	-52.00	0.49	0.668	3.757	272.81	41.06	-3.47	37.95	2.59
74.91	20.81										
49	SAGEEND	-199.12	-52.64	0.34	0.750	2.271	284.81	40.98	-3.51	37.86	2.40
74.63	20.73										
50	SAGEEND	-211.11	-52.96	0.18	0.799	0.826	296.81	40.94	-3.53	34.17	-1.83
71.40	19.83										
51	SEABED	-223.11	-53.02	0.04	0.451	0.032	308.81	40.93	-3.53	5.47	-16.59
57.06	15.85										
52	SEABED	-235.11	-53.03	0.00	0.018	-0.002	320.81	40.93	-3.53	-0.07	-3.39
45.42	12.62										
53	SEABED	-247.11	-53.02	0.00	-0.001	0.000	332.81	40.93	-3.53	-0.01	0.05
42.84	11.90										
54	SEABED	-259.11	-53.02	0.00	0.000	0.000	344.81	40.93	-3.53	0.00	0.01
42.81	11.89										
55	SEABED	-271.11	-53.02	0.00	0.000	0.000	356.81	40.93	-3.53	0.00	0.00
42.81	11.89										
56	SEABED	-283.11	-53.02	0.00	0.000	0.000	368.81	40.93	-3.53	0.00	0.00
42.81	11.89										
57	SEABED	-295.11	-53.02	0.00	0.000	0.000	380.81	40.93	-3.53	0.00	0.00
42.81	11.89										

58	SEABED	-307.11	-53.02	0.00	0.000	0.000	392.81	40.93	-3.53	0.00	0.00
42.81	11.89										

OFFPIPE - OFFSHORE PIPELINE ANALYSIS SYSTEM - VERSION 2.05 AC DATE - 5/ 6/2020 TIME - 21: 6:22
PAGE 106
PROJECT - TUGAS AKHIR JOB NO. - ANALISIS
DINAMIS
USER ID - IDA BAGUS PUNDHARA SAKYANARY LICENSED TO: RICKY TAWEKAL CASE
3

NODE TOTAL NO. STRESS (MPA)	PIPE PERCENT SECTION YIELD (PCT)	X	Y	Z	HORIZ	VERT	PIPE	TENSILE	HOOP	BENDING STRESSES	
		COORD (M)	COORD (M)	COORD (M)	ANGLE (DEG)	ANGLE (DEG)	LENGIH (M)	STRESS (MPA)	STRESS (MPA)	VERT (MPA)	HORIZ (MPA)
1	TENSIONR 48.75 13.54	77.79	6.21	0.00	0.000	0.315	0.00	48.75	0.00	0.00	0.00
3	LAYBARGE 139.35 38.71	71.49	6.16	0.00	0.000	0.957	6.30	48.73	0.00	-106.61	0.00
5	LAYBARGE 113.91 31.64	65.37	5.98	0.00	0.000	2.222	12.42	48.71	0.00	-76.71	0.00
7	LAYBARGE 123.11 34.20	59.91	5.72	0.00	0.000	3.297	17.89	48.67	0.00	-87.57	0.00
9	LAYBARGE 120.14 33.37	53.32	5.27	0.00	0.000	4.486	24.49	48.60	0.00	-84.17	0.00
11	LAYBARGE 136.47 37.91	47.32	4.74	0.00	0.000	5.781	30.51	48.51	0.00	-103.48	0.00
13	LAYBARGE 154.17 42.83	38.21	3.69	0.00	0.000	7.421	39.68	48.34	0.00	-124.51	0.00
15	LAYBARGE 135.22 37.56	29.27	2.39	0.00	0.000	9.065	48.72	48.14	0.00	-102.45	0.01
17	LAYBARGE 120.66 33.52	23.13	1.33	0.00	0.000	10.380	54.95	47.97	0.00	-85.51	-0.07
19	LAYBARGE 105.70 29.36	17.18	0.19	0.00	0.002	11.412	61.01	47.80	0.00	-68.18	0.32
21	LAYBARGE 183.12 50.87	10.63	-1.22	0.00	-0.021	13.189	67.72	47.59	-0.08	-159.31	-5.19

24	STINGER	-4.62	-5.11	0.00	0.022	15.379	83.45	47.09	-0.34	-158.79	-5.17
182.30	50.64										
26	STINGER	-11.02	-6.99	0.00	-0.004	17.153	90.12	46.87	-0.47	-66.48	-0.25
103.61	28.78										
28	STINGER	-17.37	-9.02	0.00	-0.004	18.312	96.78	46.60	-0.60	-86.36	-2.35
120.33	33.43										
30	STINGER	-23.67	-11.19	0.00	0.021	19.624	103.45	46.32	-0.75	-84.16	2.84
118.26	32.85										
32	STINGER	-29.93	-13.49	0.00	-0.096	20.829	110.12	46.03	-0.90	-73.64	-19.46
110.76	30.77										
34	STINGER	-36.14	-15.92	0.03	-0.627	21.815	116.79	45.71	-1.06	-61.19	-43.44
109.72	30.48										
36	SAGEEND	-47.27	-20.40	0.22	-1.000	21.537	128.79	45.14	-1.36	28.16	1.81
69.40	19.28										
37	SAGEEND	-58.47	-24.69	0.40	-0.852	20.285	140.79	44.59	-1.65	33.45	4.06
73.74	20.48										
38	SAGEEND	-69.78	-28.71	0.55	-0.682	18.957	152.79	44.07	-1.91	34.26	4.05
74.09	20.58										
39	SAGEEND	-81.17	-32.48	0.67	-0.518	17.605	164.79	43.58	-2.17	34.78	3.87
74.27	20.63										
40	SAGEEND	-92.65	-35.97	0.76	-0.363	16.234	176.79	43.13	-2.40	35.26	3.72
74.43	20.68										
41	SAGEEND	-104.21	-39.19	0.82	-0.215	14.841	188.79	42.71	-2.61	35.78	3.55
74.58	20.72										
42	SAGEEND	-115.85	-42.12	0.85	-0.076	13.430	200.79	42.33	-2.81	36.28	3.35
74.70	20.75										
43	SAGEEND	-127.55	-44.76	0.85	0.054	12.002	212.79	41.99	-2.98	36.70	3.12
74.81	20.78										
44	SAGEEND	-139.32	-47.11	0.83	0.173	10.558	224.79	41.69	-3.14	37.06	2.87
74.88	20.80										
45	SAGEEND	-151.14	-49.16	0.78	0.283	9.099	236.79	41.43	-3.28	37.36	2.61
74.91	20.81										
46	SAGEEND	-163.01	-50.90	0.71	0.381	7.631	248.79	41.20	-3.39	37.58	2.36
74.92	20.81										
47	SAGEEND	-174.93	-52.34	0.62	0.469	6.153	260.79	41.02	-3.49	37.82	2.17
74.89	20.80										
48	SAGEEND	-186.87	-53.47	0.51	0.552	4.665	272.79	40.87	-3.56	38.01	2.09
74.84	20.79										
49	SAGEEND	-198.84	-54.29	0.39	0.633	3.172	284.79	40.77	-3.62	38.16	2.07
74.74	20.76										
50	SAGEEND	-210.83	-54.80	0.25	0.708	1.682	296.79	40.71	-3.65	37.46	1.62
74.01	20.56										
51	SEABED	-222.83	-55.01	0.10	0.693	0.341	308.79	40.68	-3.66	25.46	-6.70
64.48	17.91										
52	SEABED	-234.83	-55.03	0.01	0.142	0.002	320.79	40.68	-3.66	1.25	-11.67
52.35	14.54										
53	SEABED	-246.83	-55.02	0.00	0.000	-0.001	332.79	40.68	-3.66	-0.06	-0.39
42.94	11.93										
54	SEABED	-258.83	-55.02	0.00	0.000	0.000	344.79	40.68	-3.66	0.00	0.03
42.65	11.85										
55	SEABED	-270.83	-55.02	0.00	0.000	0.000	356.79	40.68	-3.66	0.00	0.00
42.63	11.84										
56	SEABED	-282.83	-55.02	0.00	0.000	0.000	368.79	40.68	-3.66	0.00	0.00
42.63	11.84										
57	SEABED	-294.83	-55.02	0.00	0.000	0.000	380.79	40.68	-3.66	0.00	0.00
42.63	11.84										
58	SEABED	-306.83	-55.02	0.00	0.000	0.000	392.79	40.68	-3.66	0.00	0.00
42.63	11.84										

OFFPIPE - OFFSHORE PIPELINE ANALYSIS SYSTEM - VERSION 2.05 AC DATE - 5/ 6/2020 TIME - 21: 6:22
PAGE 106
PROJECT - TUGAS AKHIR JOB NO. - ANALISIS
DINAMIS
USER ID - IDA BAGUS FUNDHARA SAKYANARY LICENSED TO: RICKY TAMEKAL CASE
4

NODE TOTAL NO. STRESS (MPA)	PIPE BECONF SECTION YIELD (PCT)	X COORD (M)	Y COORD (M)	Z COORD (M)	HORIZ ANGLE (DEG)	VERT ANGLE (DEG)	PIPE LENGIH (M)	TENSILE STRESS (MPA)	HOOP STRESS (MPA)	BENDING VERT (MPA)	SRESSES HORIZ (MPA)
1	TENSIONR	77.79	6.21	0.00	0.000	0.313	0.00	48.69	0.00	0.00	0.00
48.69	13.52										
3	LAYBARGE	71.49	6.16	0.00	0.000	0.954	6.30	48.67	0.00	-106.59	0.00
139.26	38.68										
5	LAYBARGE	65.37	5.98	0.00	0.000	2.220	12.42	48.64	0.00	-76.69	0.00
113.83	31.62										
7	LAYBARGE	59.91	5.72	0.00	0.000	3.294	17.89	48.60	0.00	-87.55	0.00
123.02	34.17										
9	LAYBARGE	53.32	5.27	0.00	0.000	4.483	24.49	48.53	0.00	-84.14	0.00
120.05	33.35										
11	LAYBARGE	47.32	4.74	0.00	0.000	5.778	30.51	48.44	0.00	-103.45	0.00
136.37	37.88										
13	LAYBARGE	38.21	3.69	0.00	0.000	7.418	39.68	48.27	0.00	-124.47	0.00
154.06	42.80										
15	LAYBARGE	29.27	2.39	0.00	0.000	9.062	48.72	48.07	0.00	-102.41	0.01
135.12	37.53										
17	LAYBARGE	23.13	1.33	0.00	0.000	10.378	54.95	47.91	0.00	-85.50	-0.07
120.58	33.49										
19	LAYBARGE	17.18	0.19	0.00	0.002	11.409	61.01	47.73	0.00	-68.15	0.32
105.61	29.34										
21	LAYBARGE	10.63	-1.22	0.00	-0.021	13.187	67.72	47.52	-0.08	-159.39	-5.19
183.11	50.86										
24	STINGER	-4.61	-5.09	0.00	0.022	15.161	83.44	47.03	-0.34	-137.25	-5.11
163.93	45.54										
26	STINGER	-11.02	-6.94	0.00	-0.005	16.599	90.11	46.81	-0.46	-48.73	-0.50
88.45	24.57										
28	STINGER	-17.40	-8.88	0.00	0.003	17.441	96.77	46.55	-0.59	-67.36	-1.19
104.11	28.92										
30	STINGER	-23.74	-10.94	0.00	-0.009	18.445	103.44	46.29	-0.73	-67.43	-3.09
103.97	28.88										
32	STINGER	-30.05	-13.10	0.00	0.082	19.261	110.11	46.01	-0.87	-45.71	10.82
86.06	23.91										
34	STINGER	-36.32	-15.36	0.00	-0.382	20.844	116.77	45.70	-1.02	-159.38	-64.21
191.92	53.31										
36	SAGEBND	-47.46	-19.81	0.17	-1.012	21.652	128.77	45.15	-1.32	22.81	0.52
64.87	18.02										
37	SAGEBND	-58.66	-24.12	0.36	-0.879	20.462	140.77	44.59	-1.61	33.10	3.97
73.50	20.42										
38	SAGEBND	-69.94	-28.19	0.52	-0.709	19.141	152.77	44.07	-1.88	34.18	4.04
74.08	20.58										

39	SAGEEND	-81.33	-31.99	0.64	-0.544	17.792	164.77	43.58	-2.13	34.71	3.88
74.23	20.62										
40	SAGEEND	-92.79	-35.52	0.73	-0.388	16.420	176.77	43.12	-2.37	35.21	3.73
74.38	20.66										
41	SAGEEND	-104.34	-38.77	0.80	-0.239	15.029	188.77	42.70	-2.59	35.70	3.56
74.51	20.70										
42	SAGEEND	-115.97	-41.74	0.83	-0.098	13.621	200.77	42.32	-2.78	36.20	3.38
74.62	20.73										
43	SAGEEND	-127.67	-44.42	0.84	0.033	12.194	212.77	41.98	-2.96	36.65	3.16
74.71	20.75										
44	SAGEEND	-139.43	-46.81	0.82	0.154	10.753	224.77	41.67	-3.12	37.02	2.91
74.78	20.77										
45	SAGEEND	-151.24	-48.90	0.77	0.264	9.297	236.77	41.40	-3.26	37.32	2.67
74.82	20.78										
46	SAGEEND	-163.11	-50.69	0.71	0.364	7.830	248.77	41.17	-3.38	37.54	2.42
74.83	20.79										
47	SAGEEND	-175.02	-52.17	0.62	0.454	6.351	260.77	40.98	-3.48	37.78	2.22
74.82	20.78										
48	SAGEEND	-186.96	-53.34	0.52	0.537	4.863	272.77	40.83	-3.55	37.99	2.13
74.79	20.78										
49	SAGEEND	-198.93	-54.20	0.40	0.618	3.372	284.77	40.72	-3.61	38.11	2.11
74.74	20.76										
50	SAGEEND	-210.91	-54.75	0.26	0.695	1.881	296.77	40.65	-3.65	37.75	1.80
74.24	20.62										
51	SAGEEND	-222.91	-54.99	0.11	0.706	0.486	308.77	40.62	-3.66	29.73	-4.67
67.65	18.79										
52	SEAFED	-234.91	-55.03	0.01	0.191	0.007	320.77	40.62	-3.66	2.16	-14.12
54.37	15.10										
53	SEAFED	-246.91	-55.02	0.00	0.001	-0.001	332.77	40.62	-3.66	-0.08	-0.68
43.08	11.97										
54	SEAFED	-258.91	-55.02	0.00	0.000	0.000	344.77	40.62	-3.66	0.00	0.03
42.60	11.83										
55	SEAFED	-270.91	-55.02	0.00	0.000	0.000	356.77	40.62	-3.66	0.00	0.00
42.57	11.83										
56	SEAFED	-282.91	-55.02	0.00	0.000	0.000	368.77	40.62	-3.66	0.00	0.00
42.57	11.82										
57	SEAFED	-294.91	-55.02	0.00	0.000	0.000	380.77	40.62	-3.66	0.00	0.00
42.57	11.82										
58	SEAFED	-306.91	-55.02	0.00	0.000	0.000	392.77	40.62	-3.66	0.00	0.00
42.57	11.82										
59	SEAFED	-318.91	-55.02	0.00	0.000	0.000	404.77	40.62	-3.66	0.00	0.00
42.57	11.82										

NODE TOTAL NO. STRESS (MPA)	PIPE BECONF SECTION YIELD (PCT)	X COORD (M)	Y COORD (M)	Z COORD (M)	HORIZ ANGLE (DEG)	VERT ANGLE (DEG)	PIPE LENGTH (M)	TENSILE STRESS (MPA)	HOOP STRESS (MPA)	BENDING VERT (MPA)	SIRESS HORIZ (MPA)
1	TENSIONR	77.79	6.21	0.00	0.000	0.319	0.00	56.87	0.00	0.00	0.00
56.87	15.80										
3	LAYARGE	71.49	6.16	0.00	0.000	0.959	6.30	56.85	0.00	-109.02	0.00
149.52	41.53										
5	LAYARGE	65.37	5.99	0.00	0.000	2.220	12.42	56.83	0.00	-78.83	0.00
123.84	34.40										
7	LAYARGE	59.91	5.72	0.00	0.000	3.299	17.89	56.78	0.00	-89.84	0.00
133.15	36.98										
9	LAYARGE	53.32	5.27	0.00	0.000	4.484	24.49	56.71	0.00	-86.49	0.00
130.23	36.18										
11	LAYARGE	47.32	4.74	0.00	0.000	5.787	30.51	56.63	0.00	-107.23	0.00
147.77	41.05										
13	LAYARGE	38.22	3.69	0.00	0.000	7.421	39.68	56.46	0.00	-129.86	0.00
166.83	46.34										
15	LAYARGE	29.27	2.39	0.00	0.000	9.060	48.72	56.25	0.00	-106.24	0.01
146.56	40.71										
17	LAYARGE	23.13	1.33	0.00	0.000	10.381	54.95	56.09	0.00	-87.72	-0.05
130.65	36.29										
19	LAYARGE	17.18	0.19	0.00	0.001	11.410	61.01	55.91	0.00	-69.80	0.24
115.19	32.00										
21	LAYARGE	10.63	-1.22	0.00	-0.020	13.214	67.72	55.70	-0.08	-168.80	-4.97
199.23	55.34										
24	STINGER	-4.64	-5.13	0.00	0.011	15.780	83.47	55.19	-0.34	-212.88	-6.33
236.38	65.66										
26	STINGER	-11.01	-7.10	0.00	0.034	18.271	90.14	54.97	-0.47	-106.55	6.74
145.93	40.54										
28	STINGER	-17.30	-9.29	0.00	-0.180	20.015	96.81	54.68	-0.62	-121.98	-35.30
162.37	45.10										
30	STINGER	-23.54	-11.65	0.05	-0.754	21.285	103.47	54.39	-0.78	-51.77	-35.17
107.61	29.89										
32	STINGER	-29.74	-14.09	0.15	-1.046	21.407	110.14	54.08	-0.94	16.99	-1.85
68.63	19.06										
34	STINGER	-35.96	-16.50	0.27	-1.013	20.904	116.81	53.77	-1.10	26.44	2.99
76.64	21.29										
36	SAGEEND	-47.21	-20.67	0.45	-0.866	19.813	128.81	53.23	-1.38	28.42	3.63
78.02	21.67										
37	SAGEEND	-58.53	-24.63	0.61	-0.717	18.692	140.81	52.72	-1.64	28.88	3.56
78.07	21.69										
38	SAGEEND	-69.94	-28.36	0.74	-0.573	17.555	152.81	52.24	-1.89	29.24	3.44
78.06	21.68										
39	SAGEEND	-81.41	-31.87	0.84	-0.434	16.402	164.81	51.79	-2.13	29.59	3.30
78.05	21.68										
40	SAGEEND	-92.96	-35.14	0.91	-0.302	15.236	176.81	51.36	-2.34	29.91	3.18
78.06	21.68										
41	SAGEEND	-104.57	-38.17	0.96	-0.176	14.057	188.81	50.97	-2.55	30.25	3.05
78.06	21.68										
42	SAGEEND	-116.24	-40.97	0.98	-0.056	12.863	200.81	50.61	-2.73	30.59	2.90
78.07	21.69										
43	SAGEEND	-127.97	-43.52	0.98	0.056	11.658	212.81	50.28	-2.90	30.91	2.73
78.07	21.69										
44	SAGEEND	-139.74	-45.82	0.96	0.161	10.443	224.81	49.99	-3.05	31.17	2.54
78.05	21.68										
45	SAGEEND	-151.57	-47.86	0.92	0.258	9.218	236.81	49.73	-3.19	31.37	2.34
78.03	21.68										

46	SAGEEND	-163.43	-49.66	0.86	0.347	7.987	248.81	49.49	-3.31	31.55	2.14
77.99	21.66										
47	SAGEEND	-175.33	-51.20	0.77	0.427	6.747	260.81	49.30	-3.41	31.71	1.96
77.95	21.65										
48	SAGEEND	-187.26	-52.48	0.68	0.501	5.501	272.81	49.13	-3.50	31.87	1.82
77.90	21.64										
49	SAGEEND	-199.22	-53.50	0.57	0.570	4.248	284.81	49.00	-3.56	32.04	1.77
77.85	21.63										
50	SAGEEND	-211.19	-54.26	0.44	0.638	2.994	296.81	48.91	-3.61	32.13	1.77
77.78	21.61										
51	SAGEEND	-223.18	-54.75	0.30	0.705	1.739	308.81	48.84	-3.65	31.91	1.60
77.51	21.53										
52	SAGEEND	-235.18	-54.99	0.15	0.735	0.531	320.81	48.81	-3.66	27.42	-2.07
73.69	20.47										
53	SEALED	-247.18	-55.02	0.03	0.326	0.018	332.81	48.81	-3.66	2.99	-14.36
62.96	17.49										
54	SEALED	-259.18	-55.02	0.00	0.013	-0.001	344.81	48.81	-3.66	-0.02	-1.96
52.35	14.54										
55	SEALED	-271.18	-55.02	0.00	0.000	0.000	356.81	48.81	-3.66	-0.01	0.01
50.75	14.10										
56	SEALED	-283.18	-55.02	0.00	0.000	0.000	368.81	48.81	-3.66	0.00	0.00
50.74	14.10										
57	SEALED	-295.18	-55.02	0.00	0.000	0.000	380.81	48.81	-3.66	0.00	0.00
50.74	14.09										
58	SEALED	-307.18	-55.02	0.00	0.000	0.000	392.81	48.81	-3.66	0.00	0.00
50.74	14.09										
59	SEALED	-319.18	-55.02	0.00	0.000	0.000	404.81	48.81	-3.66	0.00	0.00
50.74	14.09										

OFFPIPE - OFFSHORE PIPELINE ANALYSIS SYSTEM - VERSION 2.05 AC DATE - 5/ 6/2020 TIME - 21: 6:22
PAGE 106
PROJECT - TUGAS AKHIR JOB NO. - ANALISIS
DINAMIS
USER ID - IDA BAGUS PUNDHARA SAKYANARY LICENSED TO: RICKY TAMEKAL CASE
6

NODE TOTAL NO. STRESS (MPA)	PIPE BEFORE SECTION YIELD (ECT)	X	Y	Z	HORIZ	VERT	PIPE	TENSILE	HOOP	BENDING STRESSES	
		COORD (M)	COORD (M)	COORD (M)	ANGLE (DEG)	ANGLE (DEG)	LENGIH (M)	STRESS (MPA)	STRESS (MPA)	VERT (MPA)	HORIZ (MPA)

1	TENSIONR	77.79	6.21	0.00	0.000	0.318	0.00	56.96	0.00	0.00	0.00
56.96	15.82										
3	LAYARGE	71.49	6.16	0.00	0.000	0.958	6.30	56.94	0.00	-109.08	0.00
149.66	41.57										
5	LAYARGE	65.37	5.98	0.00	0.000	2.219	12.42	56.92	0.00	-78.87	0.00
123.96	34.43										
7	LAYARGE	59.91	5.72	0.00	0.000	3.298	17.89	56.88	0.00	-89.88	0.00
133.28	37.02										
9	LAYARGE	53.32	5.27	0.00	0.000	4.483	24.49	56.81	0.00	-86.54	0.00
130.36	36.21										
11	LAYARGE	47.32	4.74	0.00	0.000	5.786	30.51	56.72	0.00	-107.30	0.00
147.92	41.09										
13	LAYARGE	38.21	3.69	0.00	0.000	7.420	39.68	56.55	0.00	-129.96	0.00
167.01	46.39										
15	LAYARGE	29.27	2.39	0.00	0.000	9.059	48.72	56.35	0.00	-106.32	0.01
146.72	40.75										
17	LAYARGE	23.13	1.33	0.00	0.000	10.380	54.95	56.18	0.00	-87.71	-0.06
130.74	36.32										
19	LAYARGE	17.18	0.18	0.00	0.001	11.410	61.01	56.01	0.00	-69.95	0.28
115.44	32.07										
21	LAYARGE	10.63	-1.22	0.00	-0.020	13.210	67.72	55.80	-0.08	-168.19	-5.10
198.87	55.24										
24	STINGER	-4.62	-5.11	0.00	0.022	15.355	83.45	55.29	-0.34	-167.72	-4.94
198.09	55.02										
26	STINGER	-11.02	-6.99	0.00	-0.008	17.152	90.12	55.07	-0.47	-67.98	-1.07
113.10	31.42										
28	STINGER	-17.37	-9.02	0.00	0.015	18.324	96.78	54.81	-0.60	-91.55	1.44
132.94	36.93										
30	STINGER	-23.67	-11.19	0.00	-0.066	19.564	103.45	54.53	-0.75	-76.27	-14.57
120.50	33.47										
32	STINGER	-29.93	-13.48	0.03	-0.568	20.621	110.12	54.24	-0.90	-71.74	-47.73
127.57	35.44										
34	STINGER	-36.16	-15.86	0.12	-0.991	20.936	116.79	53.94	-1.06	13.97	-3.88
66.20	18.39										
36	SAGEEND	-47.40	-20.06	0.31	-0.916	19.978	128.79	53.39	-1.34	27.75	3.32
77.41	21.50										
37	SAGEEND	-58.71	-24.05	0.48	-0.770	18.865	140.79	52.88	-1.60	28.82	3.57
78.03	21.68										
38	SAGEEND	-70.11	-27.82	0.62	-0.624	17.728	152.79	52.39	-1.85	29.21	3.47
78.09	21.69										
39	SAGEEND	-81.57	-31.35	0.73	-0.485	16.578	164.79	51.93	-2.09	29.56	3.33
78.11	21.70										
40	SAGEEND	-93.11	-34.66	0.81	-0.352	15.412	176.79	51.50	-2.31	29.86	3.19
78.14	21.71										
41	SAGEEND	-104.71	-37.73	0.87	-0.225	14.233	188.79	51.11	-2.52	30.20	3.07
78.19	21.72										
42	SAGEEND	-116.37	-40.56	0.90	-0.104	13.042	200.79	50.74	-2.70	30.56	2.93
78.22	21.73										
43	SAGEEND	-128.09	-43.15	0.91	0.010	11.840	212.79	50.41	-2.88	30.89	2.77
78.24	21.73										
44	SAGEEND	-139.86	-45.49	0.90	0.116	10.626	224.79	50.10	-3.03	31.16	2.58
78.24	21.73										
45	SAGEEND	-151.67	-47.57	0.87	0.214	9.405	236.79	49.84	-3.17	31.38	2.38
78.22	21.73										
46	SAGEEND	-163.53	-49.41	0.81	0.304	8.174	248.79	49.60	-3.29	31.54	2.19
78.17	21.72										
47	SAGEEND	-175.43	-50.98	0.74	0.385	6.933	260.79	49.40	-3.40	31.67	1.99
78.11	21.70										
48	SAGEEND	-187.35	-52.30	0.65	0.460	5.687	272.79	49.23	-3.49	31.84	1.85
78.03	21.67										
49	SAGEEND	-199.31	-53.36	0.55	0.530	4.436	284.79	49.09	-3.56	31.96	1.79
77.94	21.65										
50	SAGEEND	-211.28	-54.16	0.43	0.598	3.181	296.79	48.99	-3.61	32.10	1.78
77.84	21.62										
51	SAGEEND	-223.27	-54.70	0.30	0.664	1.921	308.79	48.92	-3.64	32.05	1.66
77.63	21.56										

52	SEABED	-235.26	-54.97	0.16	0.704	0.694	320.79	48.89	-3.66	29.09	-1.27
75.03	20.84										
53	SEABED	-247.26	-55.02	0.03	0.374	0.033	332.79	48.89	-3.66	4.69	-13.99
62.99	17.50										
54	SEABED	-259.26	-55.02	0.00	0.018	-0.001	344.79	48.89	-3.66	0.04	-2.57
52.84	14.68										
55	SEABED	-271.26	-55.02	0.00	-0.001	0.000	356.79	48.89	-3.66	-0.01	-0.02
50.83	14.12										
56	SEABED	-283.26	-55.02	0.00	0.000	0.000	368.79	48.89	-3.66	0.00	0.00
50.82	14.12										
57	SEABED	-295.26	-55.02	0.00	0.000	0.000	380.79	48.89	-3.66	0.00	0.00
50.82	14.12										
58	SEABED	-307.26	-55.02	0.00	0.000	0.000	392.79	48.89	-3.66	0.00	0.00
50.82	14.12										
59	SEABED	-319.26	-55.02	0.00	0.000	0.000	404.79	48.89	-3.66	0.00	0.00
50.82	14.12										
60	SEABED	-331.26	-55.02	0.00	0.000	0.000	416.79	48.89	-3.66	0.00	0.00
50.82	14.12										

OFFPIPE - OFFSHORE PIPELINE ANALYSIS SYSTEM - VERSION 2.05 AC DATE - 5/ 6/2020 TIME - 21: 6:22
PAGE 106
PROJECT - TUGAS AKHIR JOB NO. - ANALISIS
DINAMIS
USER ID - IDA BAGUS PUNDHARA SARZANARY LICENSED TO: RICKY TAWEKAL CASE
7

NODE	PIPE	X	Y	Z	HORIZ	VERT	PIPE	TENSILE	HOOP	BENDING	SIRESSSES
TOTAL	BEPOINT	COORD	COORD	COORD	ANGLE	ANGLE	LENGIH	SIRESS	SIRESS	VERT	HORIZ
NO.	SECTION	(M)	(M)	(M)	(DEG)	(DEG)	(M)	(MPA)	(MPA)	(MPA)	(MPA)
SIRESS	YIELD										
(MPA)	(PCT)										
1	TENSIONR	77.79	6.21	0.00	0.000	0.318	0.00	56.85	0.00	0.00	0.00
56.85	15.79										
3	LAYARGE	71.49	6.16	0.00	0.000	0.958	6.30	56.83	0.00	-109.02	0.00
149.49	41.53										
5	LAYARGE	65.37	5.98	0.00	0.000	2.220	12.42	56.81	0.00	-78.83	0.00
123.81	34.39										
7	LAYARGE	59.91	5.72	0.00	0.000	3.298	17.89	56.77	0.00	-89.83	0.00
133.12	36.98										
9	LAYARGE	53.32	5.27	0.00	0.000	4.483	24.49	56.70	0.00	-86.49	0.00
130.21	36.17										

11	LAYFARGE	47.32	4.74	0.00	0.000	5.786	30.51	56.61	0.00	-107.22	0.00
147.74	41.04										
13	LAYFARGE	38.21	3.69	0.00	0.000	7.420	39.68	56.44	0.00	-129.84	0.00
166.80	46.33										
15	LAYFARGE	29.27	2.39	0.00	0.000	9.059	48.72	56.24	0.00	-106.24	0.01
146.54	40.71										
17	LAYFARGE	23.13	1.33	0.00	0.000	10.380	54.95	56.07	0.00	-87.66	-0.06
130.58	36.27										
19	LAYFARGE	17.18	0.19	0.00	0.001	11.411	61.01	55.90	0.00	-70.01	0.27
115.39	32.05										
21	LAYFARGE	10.63	-1.22	0.00	-0.020	13.208	67.72	55.69	-0.08	-167.76	-5.08
198.39	55.11										
24	STINGER	-4.61	-5.09	0.00	0.021	15.144	83.44	55.19	-0.34	-144.75	-5.04
178.47	49.58										
26	STINGER	-11.02	-6.94	0.00	-0.004	16.602	90.11	54.97	-0.46	-50.04	-0.39
97.74	27.15										
28	STINGER	-17.40	-8.88	0.00	-0.001	17.445	96.77	54.72	-0.59	-69.79	-1.94
114.36	31.77										
30	STINGER	-23.74	-10.94	0.00	0.011	18.439	103.44	54.46	-0.73	-68.26	1.12
112.84	31.34										
32	STINGER	-30.05	-13.10	0.00	-0.051	19.314	110.11	54.18	-0.87	-55.28	-12.03
102.30	28.42										
34	STINGER	-36.32	-15.35	0.02	-0.539	20.196	116.77	53.89	-1.02	-71.63	-49.05
127.88	35.52										
36	SAGEBND	-47.57	-19.53	0.20	-0.940	20.078	128.77	53.35	-1.30	23.75	1.21
73.81	20.50										
37	SAGEBND	-58.87	-23.55	0.37	-0.817	19.006	140.77	52.84	-1.57	28.57	3.47
77.82	21.62										
38	SAGEBND	-70.26	-27.34	0.52	-0.672	17.874	152.77	52.35	-1.82	29.17	3.48
78.03	21.68										
39	SAGEBND	-81.71	-30.91	0.64	-0.532	16.726	164.77	51.89	-2.06	29.51	3.35
78.04	21.68										
40	SAGEBND	-93.24	-34.25	0.73	-0.398	15.562	176.77	51.46	-2.28	29.84	3.21
78.04	21.68										
41	SAGEBND	-104.83	-37.35	0.80	-0.270	14.385	188.77	51.06	-2.49	30.16	3.08
78.05	21.68										
42	SAGEBND	-116.49	-40.21	0.84	-0.149	13.198	200.77	50.69	-2.68	30.52	2.94
78.06	21.68										
43	SAGEBND	-128.20	-42.83	0.86	-0.034	11.997	212.77	50.35	-2.86	30.83	2.78
78.06	21.68										
44	SAGEBND	-139.96	-45.20	0.86	0.073	10.785	224.77	50.04	-3.01	31.10	2.59
78.06	21.68										
45	SAGEBND	-151.77	-47.32	0.83	0.172	9.565	236.77	49.77	-3.15	31.32	2.40
78.04	21.68										
46	SAGEBND	-163.62	-49.18	0.79	0.263	8.333	248.77	49.53	-3.28	31.50	2.20
78.00	21.67										
47	SAGEBND	-175.52	-50.79	0.72	0.345	7.094	260.77	49.33	-3.39	31.64	2.00
77.97	21.66										
48	SAGEBND	-187.44	-52.15	0.64	0.421	5.850	272.77	49.15	-3.48	31.80	1.84
77.92	21.65										
49	SAGEBND	-199.39	-53.24	0.55	0.490	4.600	284.77	49.01	-3.55	31.95	1.77
77.87	21.63										
50	SAGEBND	-211.36	-54.07	0.44	0.559	3.345	296.77	48.91	-3.60	32.07	1.77
77.80	21.61										
51	SAGEBND	-223.34	-54.64	0.32	0.626	2.089	308.77	48.84	-3.64	32.06	1.71
77.64	21.57										
52	SAGEBND	-235.34	-54.95	0.18	0.681	0.851	320.77	48.80	-3.66	29.98	0.54
75.79	21.05										
53	SEABED	-247.34	-55.02	0.05	0.476	0.057	332.77	48.79	-3.66	6.95	-12.96
62.67	17.41										
54	SEABED	-259.34	-55.03	0.00	0.036	-0.001	344.77	48.79	-3.66	0.12	-4.17
54.11	15.03										
55	SEABED	-271.34	-55.02	0.00	0.000	0.000	356.77	48.79	-3.66	-0.01	-0.08
50.78	14.11										
56	SEABED	-283.34	-55.02	0.00	0.000	0.000	368.77	48.79	-3.66	0.00	0.01
50.73	14.09										
57	SEABED	-295.34	-55.02	0.00	0.000	0.000	380.77	48.79	-3.66	0.00	0.00
50.72	14.09										
58	SEABED	-307.34	-55.02	0.00	0.000	0.000	392.77	48.79	-3.66	0.00	0.00
50.72	14.09										

59	SEABED	-319.34	-55.02	0.00	0.000	0.000	404.77	48.79	-3.66	0.00	0.00
50.72	14.09										
60	SEABED	-331.34	-55.02	0.00	0.000	0.000	416.77	48.79	-3.66	0.00	0.00
50.72	14.09										

OFFPIPE - OFFSHORE PIPELINE ANALYSIS SYSTEM - VERSION 2.05 AC DATE - 5/ 6/2020 TIME - 21: 6:22
PAGE 106
PROJECT - TUGAS AKHIR JOB NO. - ANALISIS
DINPMIS
USER ID - IDA BAGUS PUNDHARA SAKYANARY LICENSED TO: RICKY TAWIKAL CASE
8

NODE TOTAL NO. SIRESS (MPA)	PIPE PERCENT SECTION YIELD (PCT)	X	Y	Z	HORIZ	VERT	PIPE	TENSILE	HOOP	BENDING STRESSES	
		COORD (M)	COORD (M)	COORD (M)	ANGLE (DEG)	ANGLE (DEG)	LENGIH (M)	SIRESS (MPA)	SIRESS (MPA)	VERT (MPA)	HORIZ (MPA)
1	TENSIONR	77.79	6.21	0.00	0.000	0.321	0.00	65.09	0.00	0.00	0.00
65.09	18.08										
3	LAYBARGE	71.49	6.16	0.00	0.000	0.960	6.30	65.07	0.00	-111.47	0.00
159.82	44.40										
5	LAYBARGE	65.38	5.99	0.00	0.000	2.217	12.42	65.05	0.00	-81.00	0.00
133.89	37.19										
7	LAYBARGE	59.91	5.72	0.00	0.000	3.300	17.89	65.00	0.00	-92.14	0.00
143.32	39.81										
9	LAYBARGE	53.32	5.27	0.00	0.000	4.481	24.49	64.93	0.00	-88.87	0.00
140.47	39.02										
11	LAYBARGE	47.32	4.74	0.00	0.000	5.792	30.51	64.84	0.00	-111.03	0.00
159.22	44.23										
13	LAYBARGE	38.22	3.69	0.00	0.000	7.419	39.68	64.67	0.00	-135.26	0.00
179.65	49.90										
15	LAYBARGE	29.27	2.39	0.00	0.000	9.054	48.72	64.47	0.00	-110.10	0.01
158.06	43.91										
17	LAYBARGE	23.13	1.33	0.00	0.000	10.380	54.95	64.31	0.00	-89.93	-0.05
140.75	39.10										
19	LAYBARGE	17.18	0.19	0.00	0.001	11.408	61.01	64.13	0.00	-71.50	0.22
124.91	34.70										
21	LAYBARGE	10.63	-1.22	0.00	-0.019	13.238	67.72	63.92	-0.08	-178.29	-4.96
215.57	59.88										
24	STINGER	-4.64	-5.13	0.00	0.015	15.755	83.47	63.40	-0.34	-224.11	-5.94
254.12	70.59										

26	STINGER	-11.00	-7.10	0.00	0.018	18.269	90.14	63.18	-0.47	-109.47	5.09
156.55	43.49										
28	STINGER	-17.31	-9.28	0.01	-0.455	19.839	96.81	62.90	-0.62	-107.48	-63.45
169.00	46.94										
30	STINGER	-23.56	-11.60	0.10	-1.005	20.475	103.47	62.62	-0.77	8.11	-5.11
70.76	19.65										
32	STINGER	-29.81	-13.91	0.21	-1.007	20.091	110.14	62.32	-0.93	22.39	2.32
81.62	22.67										
34	STINGER	-36.08	-16.18	0.32	-0.940	19.576	116.81	62.03	-1.08	24.35	3.17
83.14	23.10										
36	SAGEEND	-47.42	-20.10	0.49	-0.807	18.609	128.81	61.52	-1.34	24.89	3.21
83.28	23.13										
37	SAGEEND	-58.82	-23.83	0.64	-0.677	17.629	140.81	61.04	-1.59	25.19	3.12
83.20	23.11										
38	SAGEEND	-70.29	-27.37	0.76	-0.550	16.637	152.81	60.58	-1.83	25.44	3.02
83.14	23.09										
39	SAGEEND	-81.82	-30.71	0.86	-0.430	15.633	164.81	60.15	-2.05	25.69	2.91
83.08	23.08										
40	SAGEEND	-93.40	-33.84	0.94	-0.314	14.619	176.81	59.74	-2.26	25.92	2.80
83.04	23.07										
41	SAGEEND	-105.04	-36.76	0.99	-0.203	13.597	188.81	59.37	-2.45	26.19	2.70
82.99	23.05										
42	SAGEEND	-116.72	-39.48	1.02	-0.097	12.567	200.81	59.02	-2.63	26.45	2.59
82.95	23.04										
43	SAGEEND	-128.46	-41.98	1.03	0.004	11.528	212.81	58.69	-2.80	26.68	2.47
82.90	23.03										
44	SAGEEND	-140.24	-44.27	1.02	0.099	10.481	224.81	58.40	-2.95	26.88	2.32
82.84	23.01										
45	SAGEEND	-152.06	-46.35	0.99	0.187	9.426	236.81	58.13	-3.09	27.03	2.15
82.77	22.99										
46	SAGEEND	-163.91	-48.20	0.94	0.269	8.364	248.81	57.89	-3.21	27.15	2.00
82.69	22.97										
47	SAGEEND	-175.80	-49.84	0.88	0.344	7.297	260.81	57.68	-3.32	27.25	1.84
82.59	22.94										
48	SAGEEND	-187.72	-51.25	0.80	0.413	6.224	272.81	57.50	-3.42	27.37	1.69
82.49	22.91										
49	SAGEEND	-199.66	-52.44	0.71	0.477	5.148	284.81	57.35	-3.50	27.49	1.58
82.38	22.88										
50	SAGEEND	-211.62	-53.41	0.60	0.536	4.071	296.81	57.23	-3.56	27.59	1.54
82.32	22.87										
51	SAGEEND	-223.60	-54.14	0.48	0.595	2.987	308.81	57.13	-3.61	27.68	1.54
82.24	22.84										
52	SAGEEND	-235.58	-54.66	0.35	0.653	1.901	320.81	57.07	-3.64	27.68	1.51
82.11	22.81										
53	SAGEEND	-247.58	-54.94	0.21	0.704	0.830	332.81	57.03	-3.66	26.32	0.70
80.92	22.48										
54	SEABED	-259.58	-55.02	0.07	0.558	0.076	344.81	57.02	-3.66	7.68	-10.93
69.61	19.34										
55	SEABED	-271.58	-55.02	0.00	0.079	0.001	356.81	57.02	-3.66	0.31	-7.00
64.59	17.94										
56	SEABED	-283.58	-55.02	0.00	0.001	0.000	368.81	57.02	-3.66	-0.01	-0.36
59.21	16.45										
57	SEABED	-295.58	-55.02	0.00	0.000	0.000	380.81	57.02	-3.66	0.00	0.00
58.94	16.37										
58	SEABED	-307.58	-55.02	0.00	0.000	0.000	392.81	57.02	-3.66	0.00	0.00
58.94	16.37										
59	SEABED	-319.58	-55.02	0.00	0.000	0.000	404.81	57.02	-3.66	0.00	0.00
58.94	16.37										
60	SEABED	-331.58	-55.02	0.00	0.000	0.000	416.81	57.02	-3.66	0.00	0.00
58.94	16.37										

OFFPIPE - OFFSHORE PIPELINE ANALYSIS SYSTEM - VERSION 2.05 AC DATE - 5/ 6/2020 TIME - 21: 6:22
PAGE 106
PROJECT - TUGAS AKHIR JOB NO. - ANALISIS
DINAMIS
USER ID - IDA BAGUS FUNDHARA SAKYANARY LICENSED TO: RICKY TAMEKAL CASE
9

NODE TOTAL NO. STRESS (MPA)	PIPE BECONF SECTION YIELD (PCT)	X COORD (M)	Y COORD (M)	Z COORD (M)	HORIZ ANGLE (DEG)	VERT ANGLE (DEG)	PIPE LENGIH (M)	TENSILE STRESS (MPA)	HOOP STRESS (MPA)	BENDING STRESSES VERT (MPA)	HORIZ (MPA)
1	TENSIONR	77.79	6.21	0.00	0.000	0.321	0.00	65.02	0.00	0.00	0.00
65.02	18.06										
3	LAYBARGE	71.49	6.16	0.00	0.000	0.959	6.30	65.00	0.00	-111.46	0.00
159.71	44.36										
5	LAYBARGE	65.37	5.98	0.00	0.000	2.217	12.42	64.97	0.00	-80.98	0.00
133.79	37.17										
7	LAYBARGE	59.91	5.72	0.00	0.000	3.300	17.89	64.93	0.00	-92.12	0.00
143.22	39.78										
9	LAYBARGE	53.32	5.27	0.00	0.000	4.481	24.49	64.86	0.00	-88.84	0.00
140.37	38.99										
11	LAYBARGE	47.32	4.74	0.00	0.000	5.792	30.51	64.77	0.00	-110.99	0.00
159.10	44.19										
13	LAYBARGE	38.21	3.69	0.00	0.000	7.419	39.68	64.60	0.00	-135.20	0.00
179.51	49.86										
15	LAYBARGE	29.27	2.39	0.00	0.000	9.054	48.72	64.40	0.00	-110.07	0.01
157.95	43.88										
17	LAYBARGE	23.13	1.33	0.00	0.000	10.379	54.95	64.24	0.00	-89.84	-0.05
140.59	39.05										
19	LAYBARGE	17.18	0.19	0.00	0.001	11.409	61.01	64.06	0.00	-71.82	0.23
125.10	34.75										
21	LAYBARGE	10.63	-1.23	0.00	-0.019	13.231	67.72	63.85	-0.08	-176.76	-4.99
214.18	59.50										
24	STINGER	-4.62	-5.11	0.00	0.019	15.333	83.45	63.35	-0.34	-175.94	-5.04
213.12	59.20										
26	STINGER	-11.02	-6.99	0.00	-0.002	17.161	90.12	63.13	-0.47	-71.40	-0.40
123.99	34.44										
28	STINGER	-17.37	-9.02	0.00	-0.008	18.290	96.78	62.87	-0.60	-88.68	-4.20
138.45	38.46										
30	STINGER	-23.67	-11.18	0.01	-0.421	19.472	103.45	62.59	-0.75	-77.80	-48.85
140.67	39.08										
32	STINGER	-29.94	-13.44	0.09	-0.904	19.960	110.12	62.31	-0.90	-4.08	-12.28
73.46	20.41										
34	STINGER	-36.22	-15.70	0.20	-0.963	19.660	116.79	62.02	-1.05	21.49	1.65
80.35	22.32										
36	SAGEBND	-47.55	-19.65	0.38	-0.846	18.723	128.79	61.51	-1.31	24.77	3.16
83.08	23.08										
37	SAGEBND	-58.94	-23.41	0.53	-0.716	17.743	140.79	61.03	-1.56	25.18	3.14
83.14	23.10										

38	SAGEEND	-70.40	-26.96	0.67	-0.590	16.750	152.79	60.57	-1.80	25.45	3.05
83.07	23.08										
39	SAGEEND	-81.92	-30.32	0.77	-0.468	15.749	164.79	60.13	-2.02	25.69	2.94
82.99	23.05										
40	SAGEEND	-93.50	-33.48	0.85	-0.352	14.739	176.79	59.73	-2.23	25.90	2.82
82.93	23.04										
41	SAGEEND	-105.13	-36.43	0.91	-0.240	13.719	188.79	59.35	-2.43	26.15	2.73
82.90	23.03										
42	SAGEEND	-116.81	-39.17	0.95	-0.134	12.689	200.79	58.99	-2.61	26.40	2.61
82.87	23.02										
43	SAGEEND	-128.54	-41.70	0.97	-0.032	11.649	212.79	58.67	-2.78	26.65	2.49
82.83	23.01										
44	SAGEEND	-140.32	-44.01	0.97	0.063	10.604	224.79	58.37	-2.93	26.85	2.35
82.78	22.99										
45	SAGEEND	-152.13	-46.11	0.94	0.153	9.550	236.79	58.10	-3.07	27.02	2.19
82.71	22.97										
46	SAGEEND	-163.98	-47.99	0.90	0.235	8.490	248.79	57.86	-3.20	27.15	2.03
82.62	22.95										
47	SAGEEND	-175.87	-49.66	0.85	0.311	7.424	260.79	57.64	-3.31	27.27	1.87
82.52	22.92										
48	SAGEEND	-187.78	-51.10	0.77	0.381	6.353	272.79	57.46	-3.41	27.36	1.71
82.44	22.90										
49	SAGEEND	-199.72	-52.31	0.69	0.446	5.279	284.79	57.30	-3.49	27.47	1.60
82.37	22.88										
50	SAGEEND	-211.68	-53.30	0.59	0.505	4.199	296.79	57.18	-3.55	27.59	1.55
82.31	22.86										
51	SAGEEND	-223.65	-54.07	0.48	0.564	3.114	308.79	57.08	-3.60	27.70	1.55
82.24	22.84										
52	SAGEEND	-235.64	-54.61	0.35	0.623	2.030	320.79	57.01	-3.64	27.70	1.53
82.12	22.81										
53	SAGEEND	-247.63	-54.92	0.22	0.675	0.955	332.79	56.97	-3.66	26.68	0.94
81.15	22.54										
54	SEAFED	-259.63	-55.02	0.08	0.587	0.113	344.79	56.96	-3.66	10.47	-9.62
70.08	19.47										
55	SEAFED	-271.63	-55.02	0.01	0.105	0.002	356.79	56.96	-3.66	0.51	-8.55
65.95	18.32										
56	SEAFED	-283.63	-55.02	0.00	0.002	0.000	368.79	56.96	-3.66	-0.01	-0.50
59.27	16.46										
57	SEAFED	-295.63	-55.02	0.00	0.000	0.000	380.79	56.96	-3.66	0.00	0.00
58.88	16.36										
58	SEAFED	-307.63	-55.02	0.00	0.000	0.000	392.79	56.96	-3.66	0.00	0.00
58.88	16.36										
59	SEAFED	-319.63	-55.02	0.00	0.000	0.000	404.79	56.96	-3.66	0.00	0.00
58.88	16.36										
60	SEAFED	-331.63	-55.02	0.00	0.000	0.000	416.79	56.96	-3.66	0.00	0.00
58.88	16.36										

GRAFIK ANALISA DINAMIS HEADING 180°

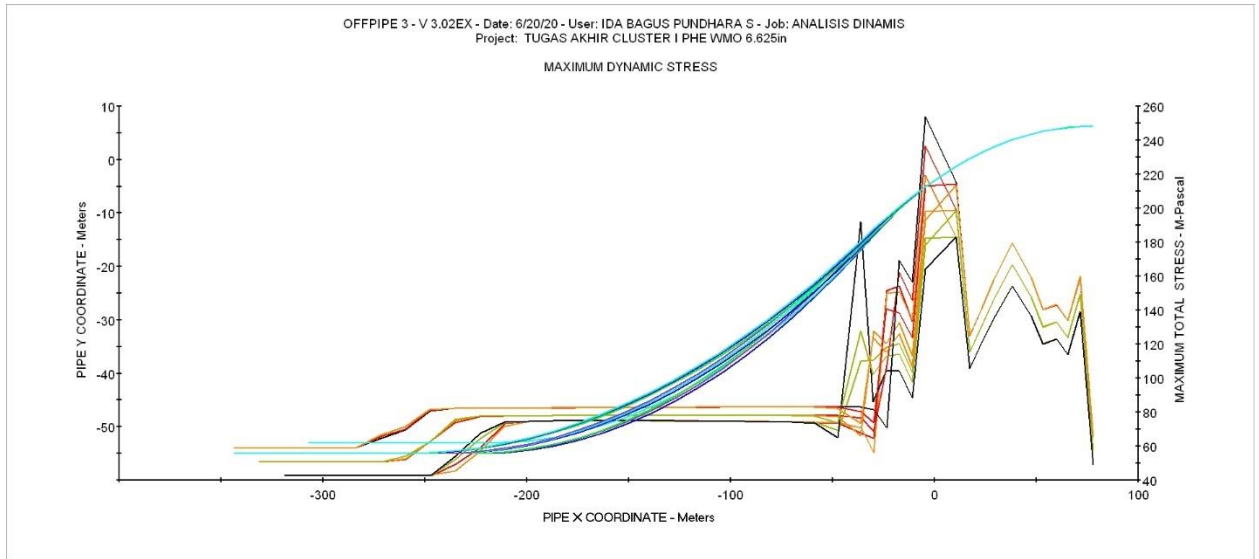

OUTPUT REGANGAN ANALISA DINAMIS HEADING 180°

SOLUTION SUMMARY									
NODE NO.	PIPE SECTION	X COORD (M)	Y COORD (M)	Z COORD (M)	SUPPORT VERT (KN)	REACT HORIZ (KN)	TOTAL MOMENT (KN-M)	TOTAL STRAIN (PCT)	PCT ALL (%)
1	TENSIONR	77.8	6.2	0.0	-2.6	0.0	0.0	0.018	0.
3	LAYBARGE	71.5	6.2	0.0	23.5	0.0	47.0	0.044	0.
5	LAYBARGE	65.4	6.0	0.0	10.1	0.0	33.8	0.068	0.
7	LAYBARGE	59.9	5.7	0.0	14.6	0.0	38.2	0.084	0.
9	LAYBARGE	53.3	5.3	0.0	13.1	0.0	36.8	0.072	0.
11	LAYBARGE	47.3	4.7	0.0	17.3	0.0	42.0	0.068	0.
13	LAYBARGE	38.2	3.7	0.0	21.6	0.0	47.5	0.045	0.
15	LAYBARGE	29.3	2.4	0.0	17.0	0.0	41.6	0.058	0.
17	LAYBARGE	23.1	1.3	0.0	13.7	0.0	37.4	0.062	0.
19	LAYBARGE	17.2	0.2	0.0	8.4	0.0	32.6	0.057	0.
21	LAYBARGE	10.6	-1.2	0.0	21.0	-1.4	54.5	0.043	0.
24	STINGER	-4.6	-5.1	0.0	26.9	-1.2	74.2	0.102	0.
26	STINGER	-11.0	-7.1	0.0	8.8	-1.4	47.9	0.045	0.
28	STINGER	-17.3	-9.3	0.0	15.9	3.5	55.6	0.064	0.
30	STINGER	-23.5	-11.7	0.0	15.5	-7.3	52.1	0.079	0.
32	STINGER	-29.7	-14.2	0.1	7.8	-4.6	26.2	0.048	0.
34	STINGER	-35.8	-16.9	0.2	0.0	0.0	7.9	0.026	0.
46	SAGBEND	-162.8	-51.0	0.7	0.0	0.0	23.4	0.043	0.
50	SEAFED	-210.7	-53.0	0.0	8.0	-3.8	9.0	0.066	0.

SOLUTION SUMMARY

NODE NO.	PIPE SECTION	X COORD (M)	Y COORD (M)	Z COORD (M)	SUPPORT VERT (KN)	REACT HORIZ (KN)	TOTAL MOMENT (KN-M)	TOTAL STRAIN (PCT)	PCT ALL (%)
1	TENSIONR	77.8	6.2	0.0	-2.6	0.0	0.0	0.018	0.
3	LAYBARGE	71.5	6.2	0.0	23.5	0.0	47.0	0.054	0.
5	LAYBARGE	65.4	6.0	0.0	10.1	0.0	33.8	0.068	0.
7	LAYBARGE	59.9	5.7	0.0	14.6	0.0	38.2	0.044	0.
9	LAYBARGE	53.3	5.3	0.0	13.1	0.0	36.8	0.062	0.
11	LAYBARGE	47.3	4.7	0.0	17.3	0.0	42.0	0.038	0.
13	LAYBARGE	38.2	3.7	0.0	21.6	0.0	47.5	0.075	0.
15	LAYBARGE	29.3	2.4	0.0	16.9	0.0	41.6	0.068	0.
17	LAYBARGE	23.1	1.3	0.0	13.8	0.0	37.5	0.053	0.
19	LAYBARGE	17.2	0.2	0.0	7.9	0.0	32.2	0.036	0.
21	LAYBARGE	10.6	-1.2	0.0	22.2	-1.4	56.4	0.083	0.
24	STINGER	-4.6	-5.1	0.0	21.8	-1.4	56.3	0.082	0.
26	STINGER	-11.0	-7.0	0.0	6.1	-0.4	31.5	0.045	0.
28	STINGER	-17.4	-9.0	0.0	11.5	-0.9	37.2	0.052	0.
30	STINGER	-23.7	-11.2	0.0	11.4	-0.4	37.1	0.051	0.
32	STINGER	-29.9	-13.5	0.0	8.3	1.7	31.7	0.045	0.
34	STINGER	-36.1	-15.9	0.0	16.8	-9.8	45.8	0.062	0.
47	SAGEEND	-174.9	-51.8	0.5	0.0	0.0	23.4	0.053	0.
50	SEABED	-210.9	-53.0	0.1	7.0	-3.8	9.5	0.037	0.

SOLUTION SUMMARY

NODE NO.	PIPE SECTION	X COORD (M)	Y COORD (M)	Z COORD (M)	SUPPORT VERT (KN)	REACT HORIZ (KN)	TOTAL MOMENT (KN-M)	TOTAL STRAIN (PCT)	PCT ALL (%)
1	TENSIONR	77.8	6.2	0.0	-2.6	0.0	0.0	0.018	0.
3	LAYBARGE	71.5	6.2	0.0	23.5	0.0	47.0	0.054	0.
5	LAYBARGE	65.4	6.0	0.0	10.1	0.0	33.8	0.038	0.
7	LAYBARGE	59.9	5.7	0.0	14.6	0.0	38.2	0.044	0.
9	LAYBARGE	53.3	5.3	0.0	13.1	0.0	36.8	0.062	0.
11	LAYBARGE	47.3	4.7	0.0	17.3	0.0	42.0	0.048	0.
13	LAYBARGE	38.2	3.7	0.0	21.6	0.0	47.5	0.035	0.
15	LAYBARGE	29.3	2.4	0.0	16.9	0.0	41.6	0.058	0.
17	LAYBARGE	23.1	1.3	0.0	13.9	0.0	37.6	0.043	0.
19	LAYBARGE	17.2	0.2	0.0	7.7	0.0	31.9	0.056	0.
21	LAYBARGE	10.6	-1.2	0.0	22.8	-1.4	57.3	0.046	0.
24	STINGER	-4.6	-5.1	0.0	19.4	-1.4	47.4	0.034	0.
26	STINGER	-11.0	-6.9	0.0	4.5	-0.1	23.0	0.055	0.
28	STINGER	-17.4	-8.9	0.0	10.4	-1.9	29.2	0.072	0.
30	STINGER	-23.7	-10.9	0.0	9.2	2.1	27.1	0.069	0.
32	STINGER	-30.0	-13.1	0.0	0.9	0.5	21.8	0.053	0.
34	STINGER	-36.3	-15.4	0.0	32.4	-10.2	80.5	0.103	0.
46	SAGEEND	-163.0	-50.5	0.7	0.0	0.0	23.3	0.053	0.

50	SEABED	-210.9	-53.0	0.1	6.1	-3.5	10.2	0.067	0.
SOLUTION SUMMARY									
NODE NO.	FILE SECTION	X COORD (M)	Y COORD (M)	Z COORD (M)	SUPPORT VERT (KN)	REACT HORIZ (KN)	TOTAL MOMENT (KN-M)	TOTAL STRAIN (PCT)	PCT ALL (%)
1	TENSIONR	77.8	6.2	0.0	-2.4	0.0	0.0	0.024	0.
3	LAYBARGE	71.5	6.2	0.0	25.8	0.0	48.1	0.052	0.
5	LAYBARGE	65.4	6.0	0.0	12.0	0.0	34.8	0.046	0.
7	LAYBARGE	59.9	5.7	0.0	16.7	0.0	39.3	0.051	0.
9	LAYBARGE	53.3	5.3	0.0	15.1	0.0	37.9	0.069	0.
11	LAYBARGE	47.3	4.7	0.0	19.9	0.0	43.7	0.076	0.
13	LAYBARGE	38.2	3.7	0.0	24.8	0.0	50.0	0.064	0.
15	LAYBARGE	29.3	2.4	0.0	19.6	0.0	43.3	0.046	0.
17	LAYBARGE	23.1	1.3	0.0	15.8	0.0	38.5	0.060	0.
19	LAYBARGE	17.2	0.2	0.0	9.7	-0.1	33.0	0.073	0.
21	LAYBARGE	10.6	-1.2	0.0	25.6	-1.3	59.8	0.065	0.
24	STINGER	-4.6	-5.1	0.0	32.6	-2.4	80.0	0.109	0.
26	STINGER	-11.0	-7.1	0.0	12.6	5.2	50.6	0.054	0.
28	STINGER	-17.3	-9.3	0.0	21.3	-12.4	57.9	0.062	0.
30	STINGER	-23.5	-11.6	0.1	3.5	-2.1	13.9	0.049	0.
32	STINGER	-29.8	-14.0	0.2	0.0	0.0	8.9	0.053	0.
34	STINGER	-36.0	-16.4	0.3	0.0	0.0	13.4	0.039	0.
47	SAGEBND	-175.7	-49.8	0.9	0.0	0.0	16.8	0.051	0.
52	SEABED	-235.5	-53.0	0.1	4.9	-2.9	8.8	0.032	0.

SOLUTION SUMMARY									
NODE NO.	FILE SECTION	X COORD (M)	Y COORD (M)	Z COORD (M)	SUPPORT VERT (KN)	REACT HORIZ (KN)	TOTAL MOMENT (KN-M)	TOTAL STRAIN (PCT)	PCT ALL (%)
1	TENSIONR	77.8	6.2	0.0	-2.4	0.0	0.0	0.024	0.
3	LAYBARGE	71.5	6.2	0.0	25.8	0.0	48.1	0.042	0.
5	LAYBARGE	65.4	6.0	0.0	12.0	0.0	34.8	0.056	0.
7	LAYBARGE	59.9	5.7	0.0	16.7	0.0	39.3	0.061	0.
9	LAYBARGE	53.3	5.3	0.0	15.1	0.0	37.9	0.049	0.
11	LAYBARGE	47.3	4.7	0.0	19.9	0.0	43.7	0.036	0.
13	LAYBARGE	38.2	3.7	0.0	24.8	0.0	50.0	0.084	0.
15	LAYBARGE	29.3	2.4	0.0	19.6	0.0	43.3	0.076	0.
17	LAYBARGE	23.1	1.3	0.0	15.9	0.0	38.6	0.070	0.
19	LAYBARGE	17.2	0.2	0.0	9.4	0.0	32.6	0.042	0.
21	LAYBARGE	10.6	-1.2	0.0	26.6	-1.4	61.2	0.094	0.
24	STINGER	-4.6	-5.1	0.0	26.3	-1.2	61.0	0.093	0.
26	STINGER	-11.0	-7.0	0.0	7.4	-1.2	31.8	0.061	0.
28	STINGER	-17.4	-9.0	0.0	15.5	2.8	40.3	0.041	0.
30	STINGER	-23.7	-11.2	0.0	12.0	-7.0	35.3	0.035	0.
32	STINGER	-29.9	-13.5	0.1	9.2	-5.3	23.0	0.050	0.

34	STINGER	-36.2	-15.8	0.2	0.0	0.0	7.2	0.061	0.
46	SAGEBND	-163.8	-48.2	0.9	0.0	0.0	16.7	0.051	0.
52	SEABED	-235.6	-53.0	0.1	3.9	-2.4	10.2	0.063	0.

SOLUTION SUMMARY

NODE NO.	PIPE SECTION	X	Y	Z	SUPPORT REACT		TOTAL	TOTAL	PCT
		COORD (M)	COORD (M)	COORD (M)	VERT (KN)	HORIZ (KN)	MOMENT (KN-M)	STRAIN (PCT)	ALL (%)
1	TENSIONR	77.8	6.2	0.0	-2.4	0.0	0.0	0.024	0.
3	LAYBARGE	71.5	6.2	0.0	25.8	0.0	48.1	0.062	0.
5	LAYBARGE	65.4	6.0	0.0	12.0	0.0	34.8	0.046	0.
7	LAYBARGE	59.9	5.7	0.0	16.7	0.0	39.3	0.051	0.
9	LAYBARGE	53.3	5.3	0.0	15.1	0.0	37.9	0.069	0.
11	LAYBARGE	47.3	4.7	0.0	19.9	0.0	43.7	0.046	0.
13	LAYBARGE	38.2	3.7	0.0	24.8	0.0	50.0	0.024	0.
15	LAYBARGE	29.3	2.4	0.0	19.6	0.0	43.3	0.046	0.
17	LAYBARGE	23.1	1.3	0.0	15.9	0.0	38.6	0.050	0.
19	LAYBARGE	17.2	0.2	0.0	9.2	0.0	32.4	0.062	0.
21	LAYBARGE	10.6	-1.2	0.0	27.1	-1.4	61.8	0.095	0.
24	STINGER	-4.6	-5.1	0.0	23.0	-1.4	51.4	0.085	0.
26	STINGER	-11.0	-6.9	0.0	5.6	-0.4	23.4	0.061	0.
28	STINGER	-17.4	-8.9	0.0	12.0	-1.0	30.0	0.069	0.
30	STINGER	-23.7	-10.9	0.0	11.4	1.5	29.0	0.048	0.
32	STINGER	-30.0	-13.1	0.0	9.4	-5.4	26.4	0.054	0.
34	STINGER	-36.3	-15.3	0.1	9.6	-5.6	22.3	0.049	0.
45	SAGEBND	-152.1	-46.3	0.9	0.0	0.0	16.6	0.031	0.
52	SEABED	-235.7	-53.0	0.1	3.0	-1.8	11.6	0.055	0.

SOLUTION SUMMARY

NODE NO.	PIPE SECTION	X	Y	Z	SUPPORT REACT		TOTAL	TOTAL	PCT
		COORD (M)	COORD (M)	COORD (M)	VERT (KN)	HORIZ (KN)	MOMENT (KN-M)	STRAIN (PCT)	ALL (%)
1	TENSIONR	77.8	6.2	0.0	-2.6	0.0	0.0	0.018	0.
3	LAYBARGE	71.5	6.2	0.0	23.5	0.0	47.0	0.074	0.
5	LAYBARGE	65.4	6.0	0.0	10.1	0.0	33.9	0.078	0.
7	LAYBARGE	59.9	5.7	0.0	14.6	0.0	38.3	0.064	0.
9	LAYBARGE	53.3	5.3	0.0	13.1	0.0	36.8	0.072	0.
11	LAYBARGE	47.3	4.7	0.0	17.3	0.0	42.0	0.068	0.
13	LAYBARGE	38.2	3.7	0.0	21.6	0.0	47.5	0.035	0.
15	LAYBARGE	29.3	2.4	0.0	17.0	0.0	41.6	0.048	0.
17	LAYBARGE	23.1	1.3	0.0	13.7	0.0	37.4	0.052	0.
19	LAYBARGE	17.2	0.2	0.0	8.4	0.0	32.6	0.077	0.
21	LAYBARGE	10.6	-1.2	0.0	20.9	-1.4	54.5	0.063	0.
24	STINGER	-4.6	-5.1	0.0	26.9	-1.3	74.2	0.113	0.
26	STINGER	-11.0	-7.1	0.0	8.9	-0.8	48.0	0.055	0.
28	STINGER	-17.3	-9.3	0.0	15.7	1.0	55.2	0.063	0.

30	STINGER	-23.5	-11.7	0.0	14.0	-1.6	50.5	0.048	0.
32	STINGER	-29.7	-14.3	0.0	14.3	-8.3	44.0	0.060	0.
34	STINGER	-35.8	-17.0	0.1	0.0	0.0	4.9	0.043	0.
47	SAGEBND	-174.1	-54.5	0.6	0.0	0.0	23.6	0.033	0.
50	SEAFED	-210.0	-56.0	0.1	4.7	-2.8	12.2	0.020	0.

SOLUTION SUMMARY

NODE NO.	FILE SECTION	X COORD (M)	Y COORD (M)	Z COORD (M)	SUPPORT VERT (KN)	REACT HORIZ (KN)	TOTAL MOMENT (KN-M)	TOTAL STRAIN (PCT)	PCT ALL (%)
1	TENSIONR	77.8	6.2	0.0	-2.6	0.0	0.0	0.018	0.
3	LAYBARGE	71.5	6.2	0.0	23.5	0.0	47.0	0.044	0.
5	LAYBARGE	65.4	6.0	0.0	10.1	0.0	33.8	0.038	0.
7	LAYBARGE	59.9	5.7	0.0	14.6	0.0	38.2	0.064	0.
9	LAYBARGE	53.3	5.3	0.0	13.1	0.0	36.8	0.052	0.
11	LAYBARGE	47.3	4.7	0.0	17.3	0.0	42.0	0.048	0.
13	LAYBARGE	38.2	3.7	0.0	21.6	0.0	47.5	0.055	0.
15	LAYBARGE	29.3	2.4	0.0	17.0	0.0	41.6	0.078	0.
17	LAYBARGE	23.1	1.3	0.0	13.8	0.0	37.5	0.093	0.
19	LAYBARGE	17.2	0.2	0.0	8.0	0.0	32.2	0.086	0.
21	LAYBARGE	10.6	-1.2	0.0	22.2	-1.4	56.4	0.085	0.
24	STINGER	-4.6	-5.1	0.0	21.8	-1.4	56.3	0.055	0.
26	STINGER	-11.0	-7.0	0.0	6.1	-0.4	31.4	0.065	0.
28	STINGER	-17.4	-9.0	0.0	11.8	-0.9	37.5	0.072	0.
30	STINGER	-23.7	-11.2	0.0	10.7	-0.9	36.0	0.050	0.
32	STINGER	-29.9	-13.5	0.0	7.0	4.0	33.5	0.037	0.
34	STINGER	-36.1	-15.9	0.0	23.5	-11.6	63.1	0.124	0.
47	SAGEBND	-174.3	-54.2	0.6	0.0	0.0	23.6	0.033	0.
50	SEAFED	-210.2	-56.0	0.1	2.9	-1.7	15.8	0.044	0.

SOLUTION SUMMARY

NODE NO.	FILE SECTION	X COORD (M)	Y COORD (M)	Z COORD (M)	SUPPORT VERT (KN)	REACT HORIZ (KN)	TOTAL MOMENT (KN-M)	TOTAL STRAIN (PCT)	PCT ALL (%)
1	TENSIONR	77.8	6.2	0.0	-2.6	0.0	0.0	0.018	0.
3	LAYBARGE	71.5	6.2	0.0	23.5	0.0	47.0	0.054	0.
5	LAYBARGE	65.4	6.0	0.0	10.1	0.0	33.8	0.048	0.
7	LAYBARGE	59.9	5.7	0.0	14.6	0.0	38.2	0.034	0.
9	LAYBARGE	53.3	5.3	0.0	13.1	0.0	36.8	0.042	0.
11	LAYBARGE	47.3	4.7	0.0	17.3	0.0	42.0	0.068	0.
13	LAYBARGE	38.2	3.7	0.0	21.6	0.0	47.5	0.045	0.
15	LAYBARGE	29.3	2.4	0.0	16.9	0.0	41.6	0.058	0.
17	LAYBARGE	23.1	1.3	0.0	13.9	0.0	37.6	0.063	0.
19	LAYBARGE	17.2	0.2	0.0	7.7	0.0	31.9	0.056	0.
21	LAYBARGE	10.6	-1.2	0.0	22.8	-1.4	57.3	0.066	0.
24	STINGER	-4.6	-5.1	0.0	19.4	-1.4	47.4	0.054	0.

26	STINGER	-11.0	-6.9	0.0	4.3	-0.1	22.8	0.034	0.
28	STINGER	-17.4	-8.9	0.0	11.3	-2.0	30.2	0.043	0.
30	STINGER	-23.7	-10.9	0.0	7.2	2.3	23.6	0.055	0.
32	STINGER	-30.1	-13.1	0.0	0.0	0.0	24.6	0.066	0.
34	STINGER	-36.3	-15.4	0.0	39.1	-10.0	97.9	0.095	0.
47	SAGEBND	-174.3	-54.0	0.6	0.0	0.0	23.5	0.063	0.
51	SEAFED	-222.3	-56.0	0.0	8.2	-3.5	8.1	0.045	0.

BIODATA PENULIS



Penulis tugas akhir ini adalah Ida Bagus Pundhara Sakyanary, lahir pada 3 juni 1998 di Denpasar, Bali. Penulis merupakan anak pertama dari dua bersaudara. Penulis menempuh pendidikan dasar mulai dari TK Simon Petrus dan dilanjutkan dengan SD Saraswati 2 Denpasar, SMP Negeri 1 Denpasar, SMA Negeri 1 Denpasar. Penulis menamatkan masa SMA pada tahun 2016, dan diterima di Departemen Teknik Kelautan, Fakultas Teknologi Kelautan, Institut Teknologi Sepuluh Nopember (ITS) Surabaya melalui jalur PKM.

Penulis menempuh masa studi kuliah selama 4 tahun hingga tahun 2020. Selama menempuh studi perkuliahan, penulis mengikuti berbagai kegiatan dari organisasi yang ada di ITS. Dimulai dari menjadi Staff Asia Passific Student Chapter (APSC) PETROLIDA 2018, hingga menjadi Ketua Divisi Acara Gempita Pesona Dewata (GPD) yang diselenggarakan oleh Tim Pembina Kerohanian Hindu (TPKH-ITS) pada tahun 2019. Selain itu penulis juga melaksanakan kerja praktik di PT. PHE WMO pada Divisi Project.

Selama menjalani masa perkuliahan, penulis mulai menemukan ketertarikan pada bidang Perancangan dan Produksi Bangunan Lepas Pantai, khususnya pada bagian Pipa Bawah Laut. Maka dari itu, penulis mengangkat topik instalasi pipa bawah laut dalam Tugas Akhir ini.

Informasi Kontak

Email : ibpundhara23@gmail.com